

A	B	C (mm)			D
1	F52-304	826	420	16	1/1

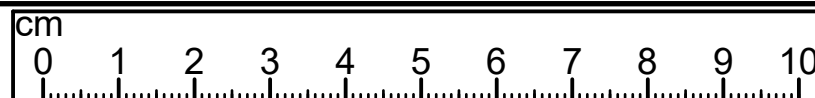

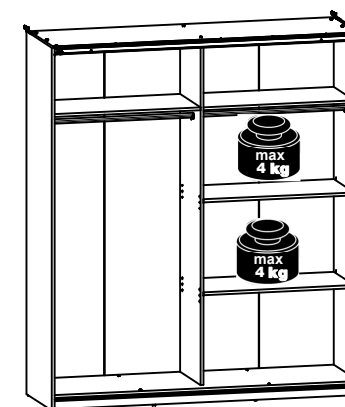
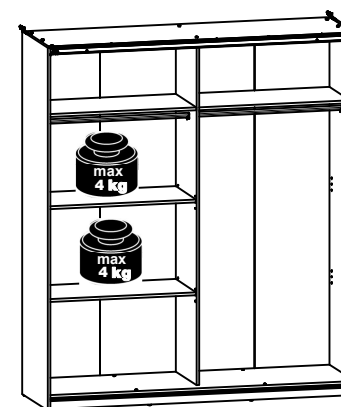
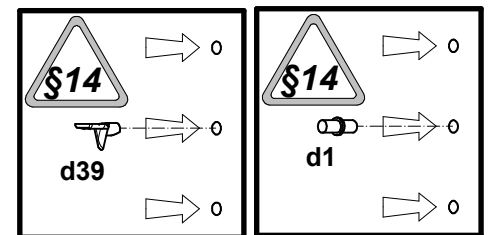
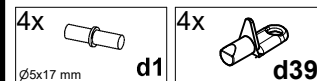
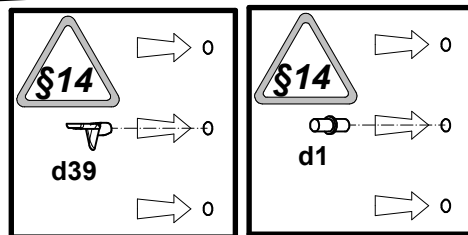
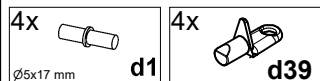
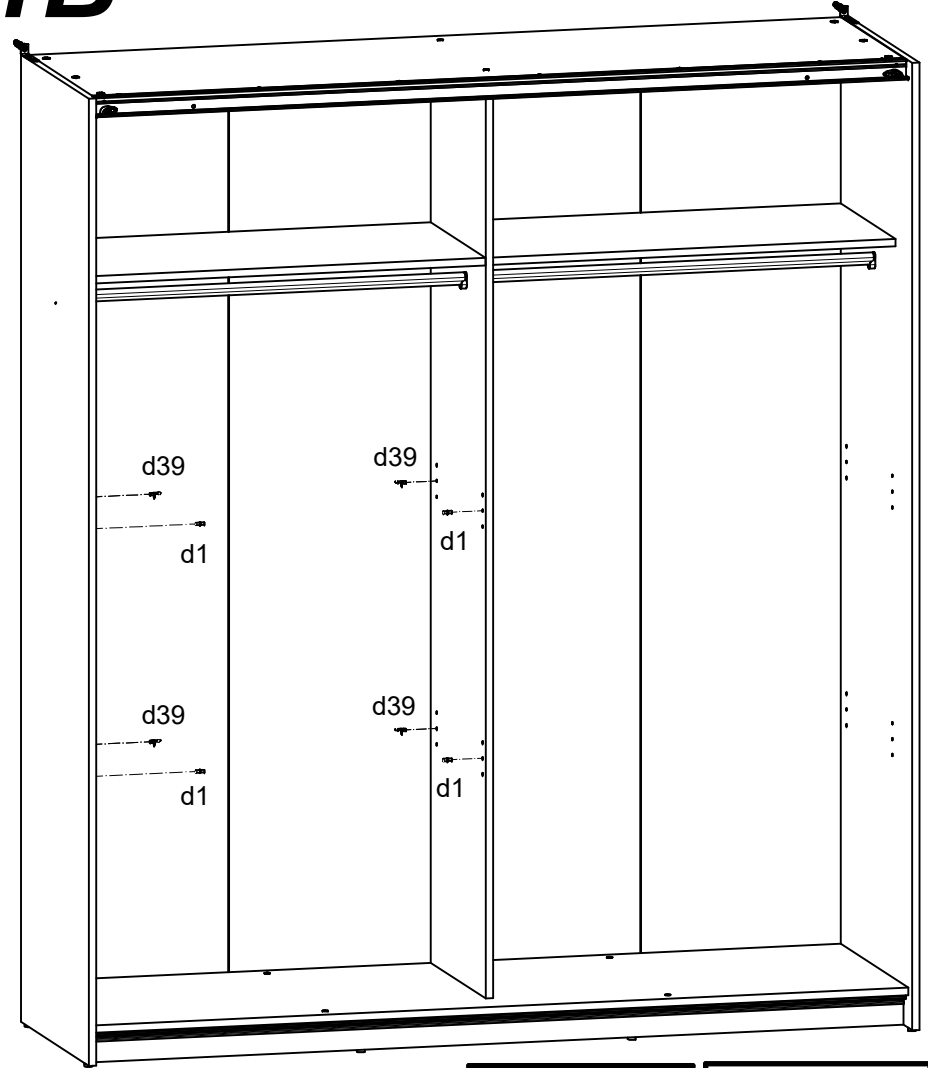
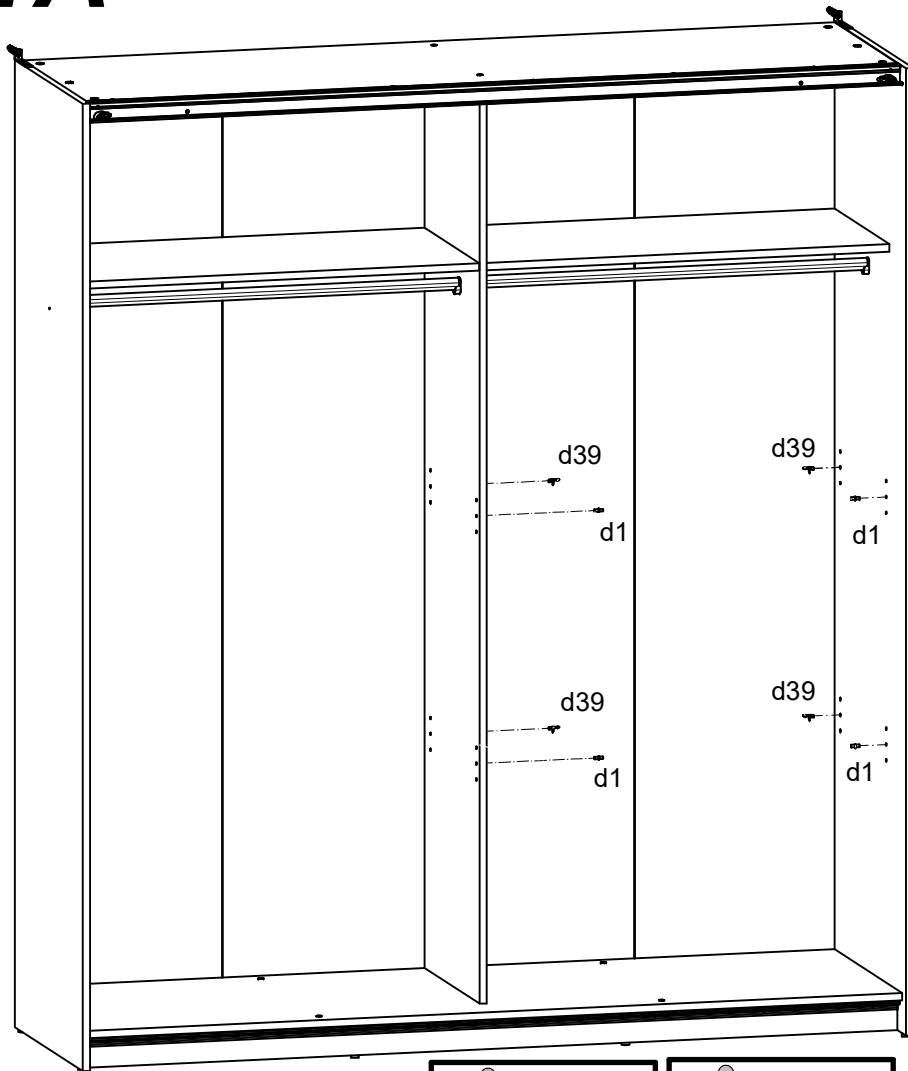

1A

1B

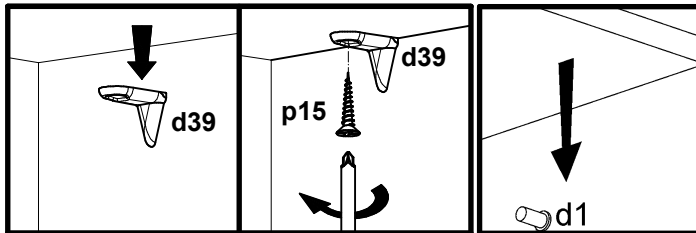
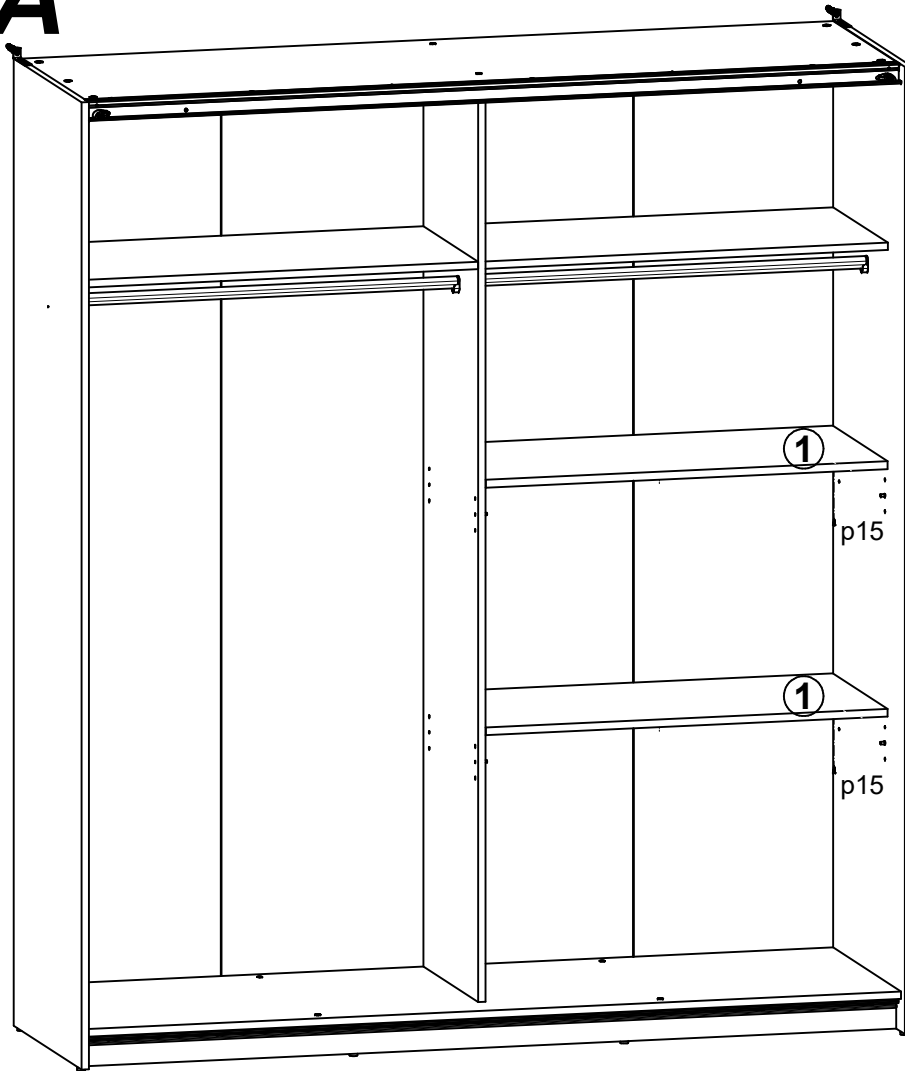

2A



4x  p15
Ø2,5x13 mm

2B

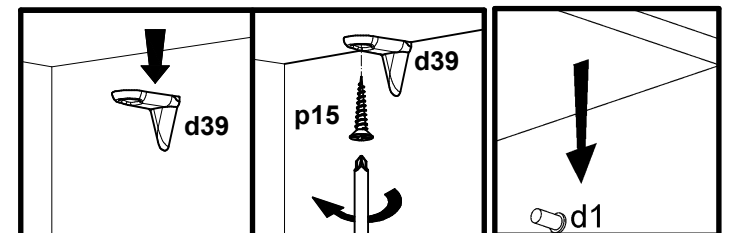
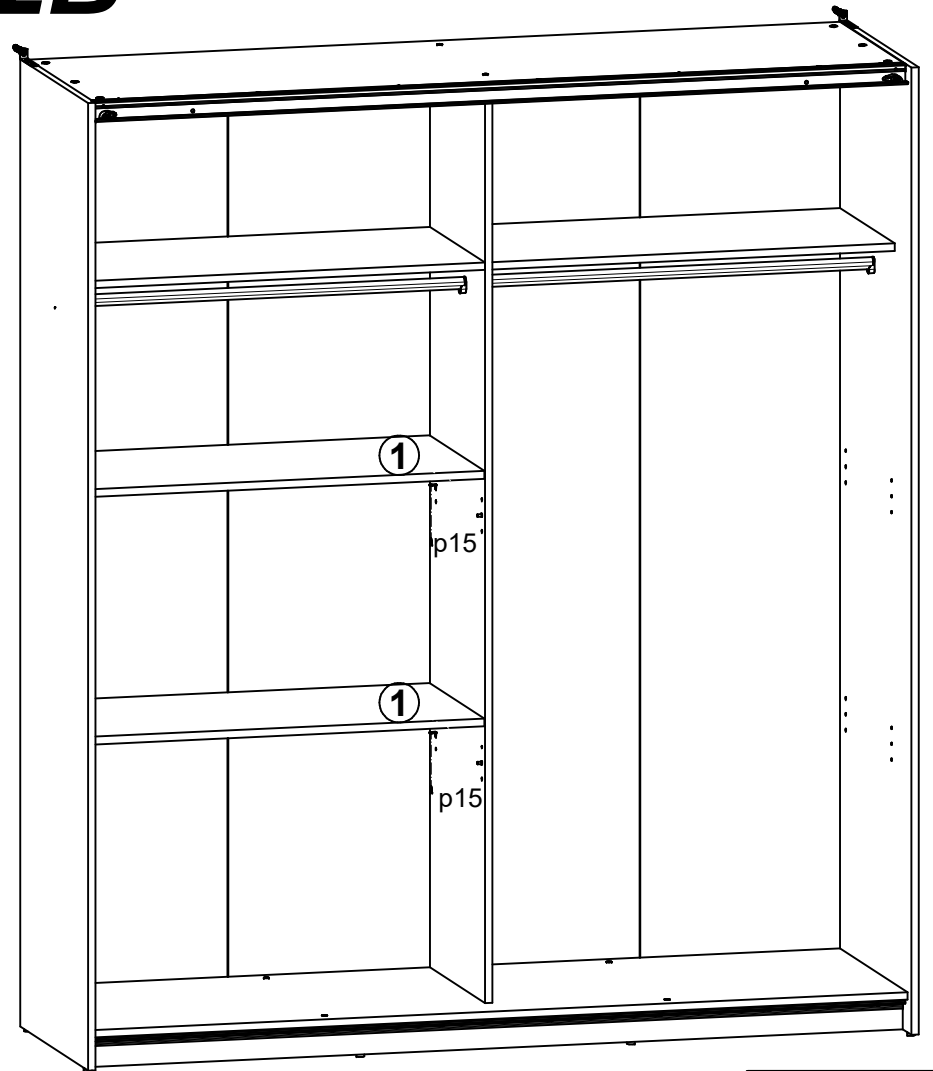

4x  p15
Ø2,5x13 mm