

FINLEY

Nr 1/2

MONTAGEANLEITUNG / SERVICEKARTE

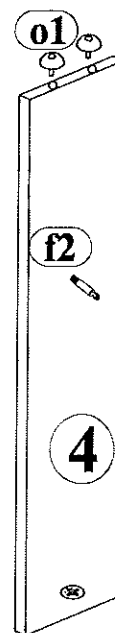
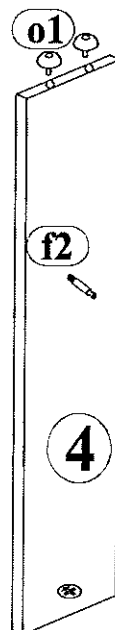
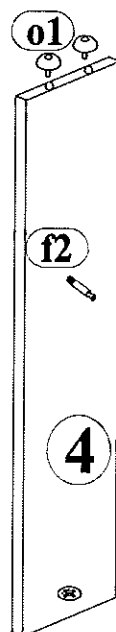
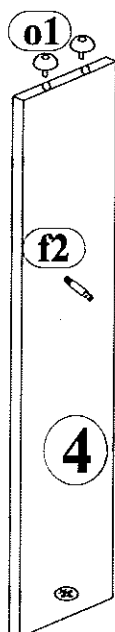
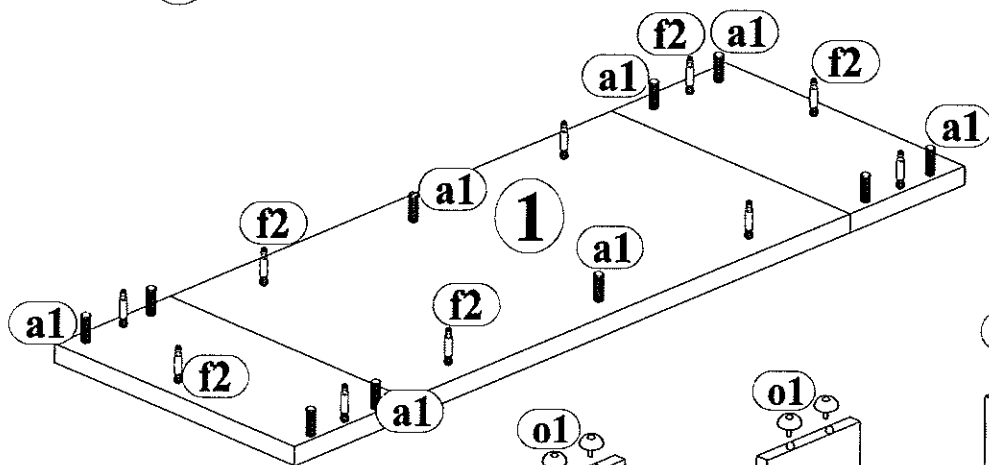
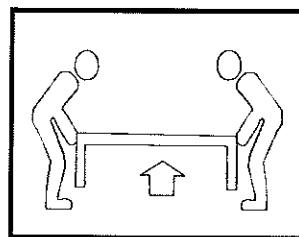
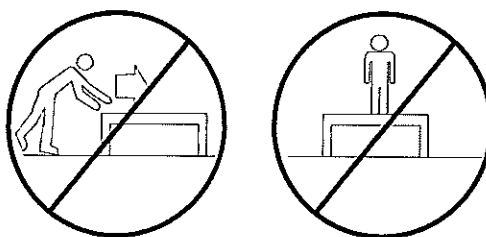
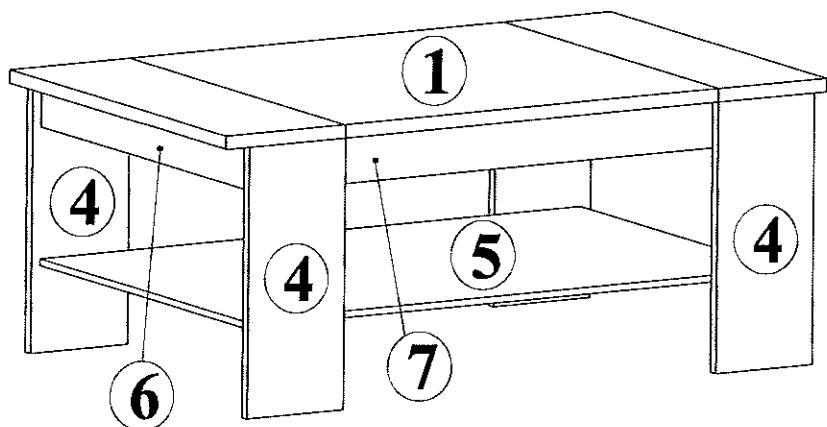
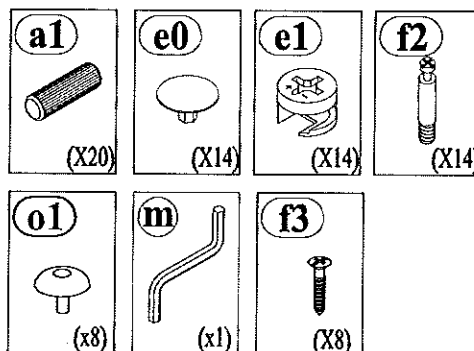

MONTAGEANLEITUNG / SERVICEKARTE

