

<http://www.bega-gruppe.de>

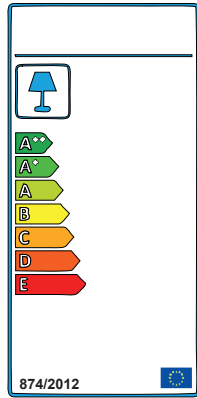

BG	Bulgarisch	български
CS	Tschechisch	čeština
DA	Dänisch	Dansk
DE	Deutsch	Deutsch
ET	Estonisch	Eesti
EL	Griechisch	ελληνικά
EN	English	English
ES	Spanisch	español
FR	Französisch	Français
FI	Finnisch	suomalainen
HR	Kroatisch	hrvatski
HU	Ungarisch	magyar
IT	Italienisch	italiano
LV	Lettisch	Latvijas
LT	Litauisch	Lietuvos
NL	Niederländisch	Nederlands
PL	Polnisch	Polski
PT	Portugiesisch	português
RO	Rumänisch	român
SK	Slowakisch	slovenský
SL	Slowenisch	slovensčina
SV	Schwedisch	Svenska

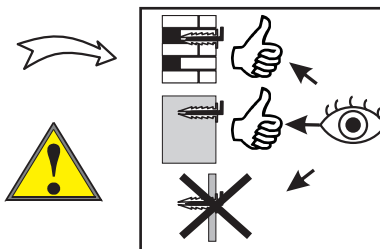
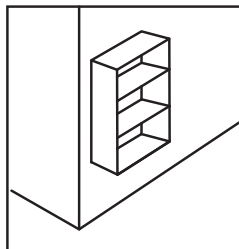
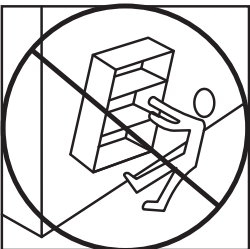
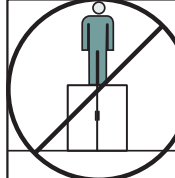
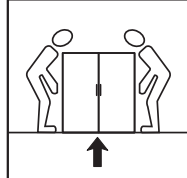
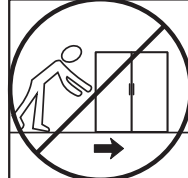
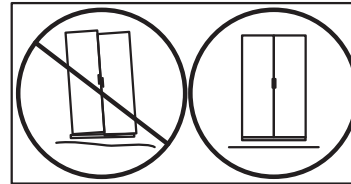
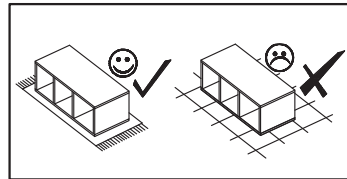
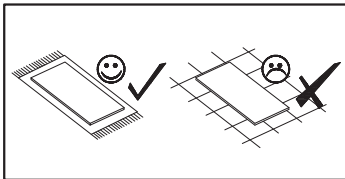
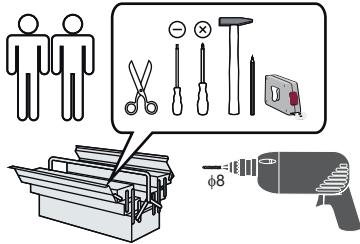
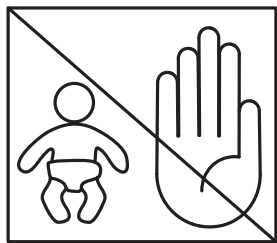

ČÍSLO ROZMĚR/  
ROZMER KS BALENÍ/  
BALENIE

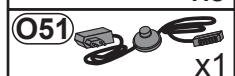
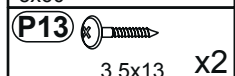
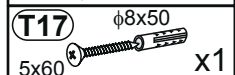
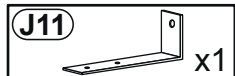
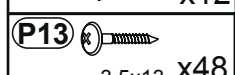
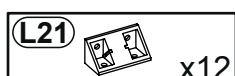
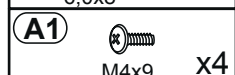
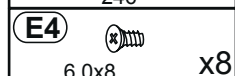
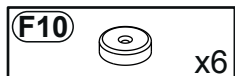
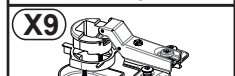
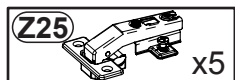
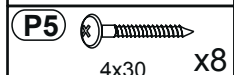
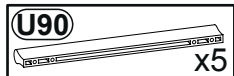
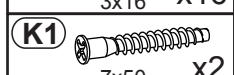
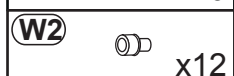
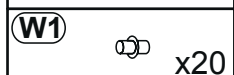
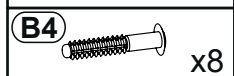
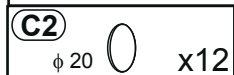
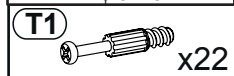
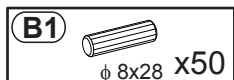

Nr	Ausmaß		St	Colli
1	333	290	5 3	1
2	1192	346	4 1	2
3	1286	350	15 1	2
4	1286	350	15 1	2
5	300	100	12 2	2
6	300	100	12 2	2
7	446	146	16 2	2
8	1192	446	16 4	2
9	894	446	16 3	2
10	330	290	15 1	2
11	1286	330	15 1	1
12	1286	330	15 1	1
13	486	325	15 5	1
14	1198	60	16 1	2
15	1198	60	16 1	2
16	486	60	16 1	2
17	1370	60	16 2	1
18	401	100	12 2	2
19	1370	350	15 1	1
20	1370	350	15 1	1
21	412	299	2 2	2
22	1300	500	2 2	2
23	1300	348	2 1	1

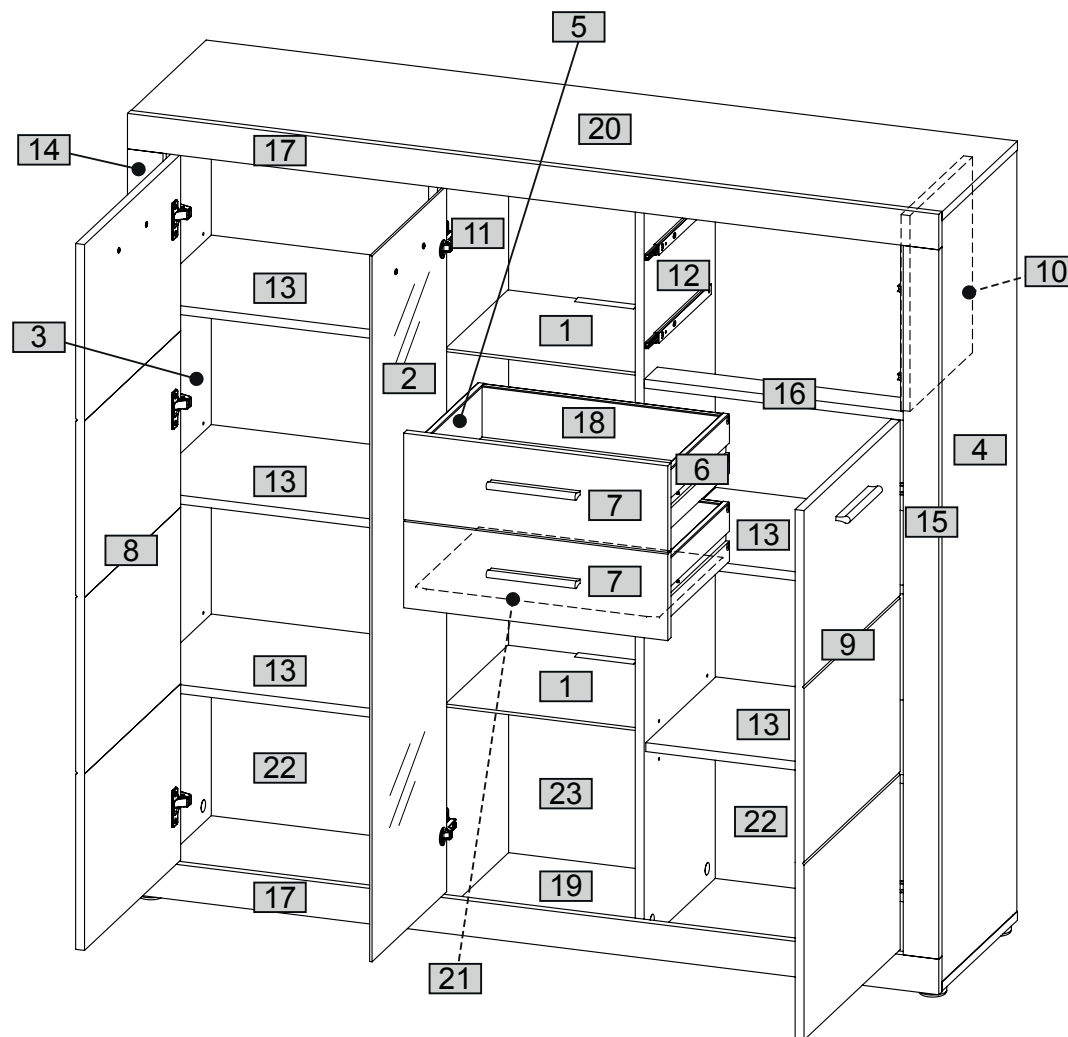

0 10 20 30 40 50 60 70 80 90 100 110 120 130 140 150 160 170 180 190 200



1

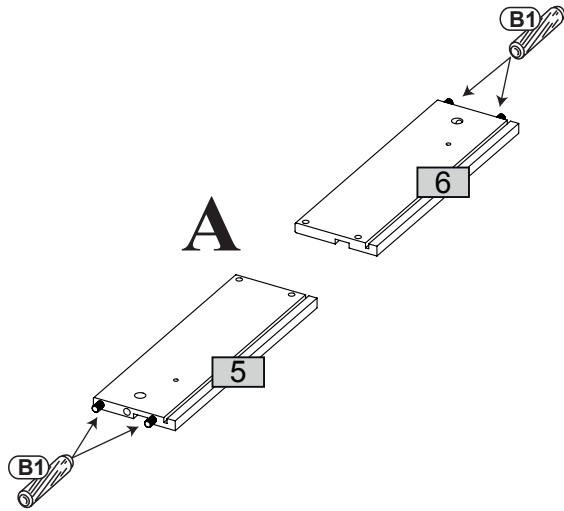
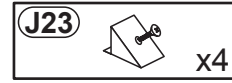
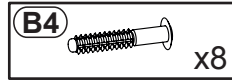
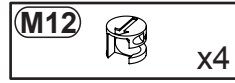
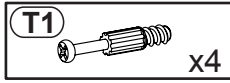
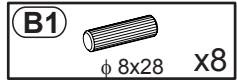

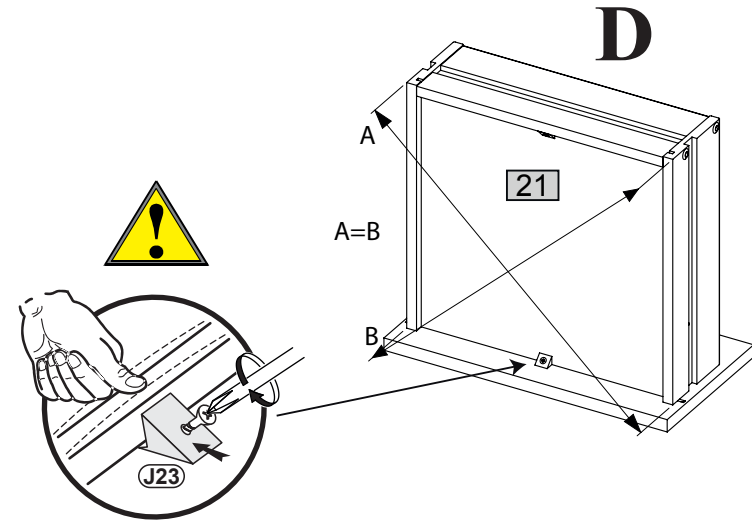
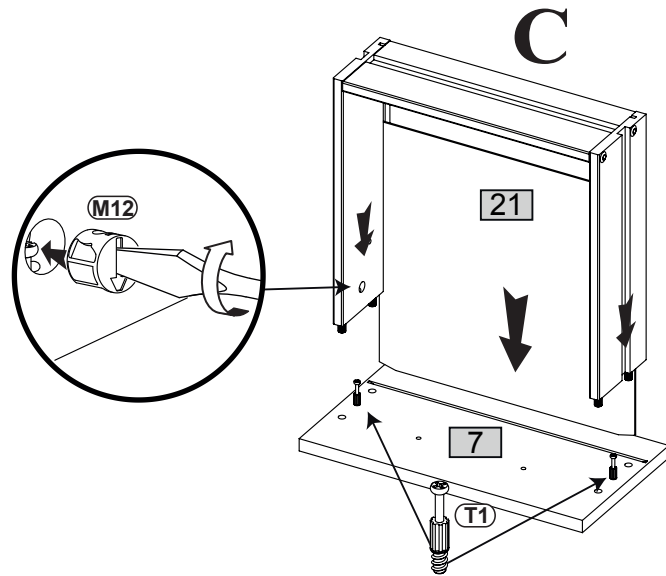
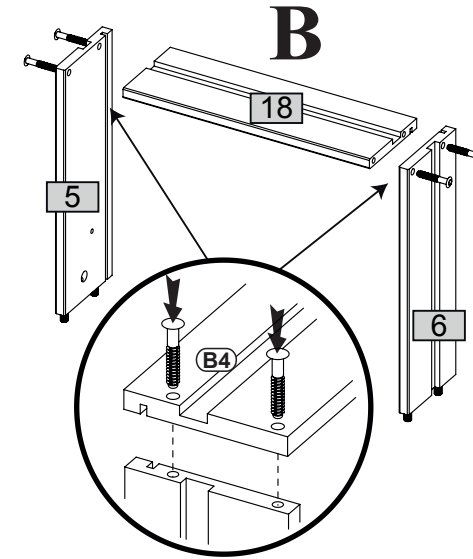

x2



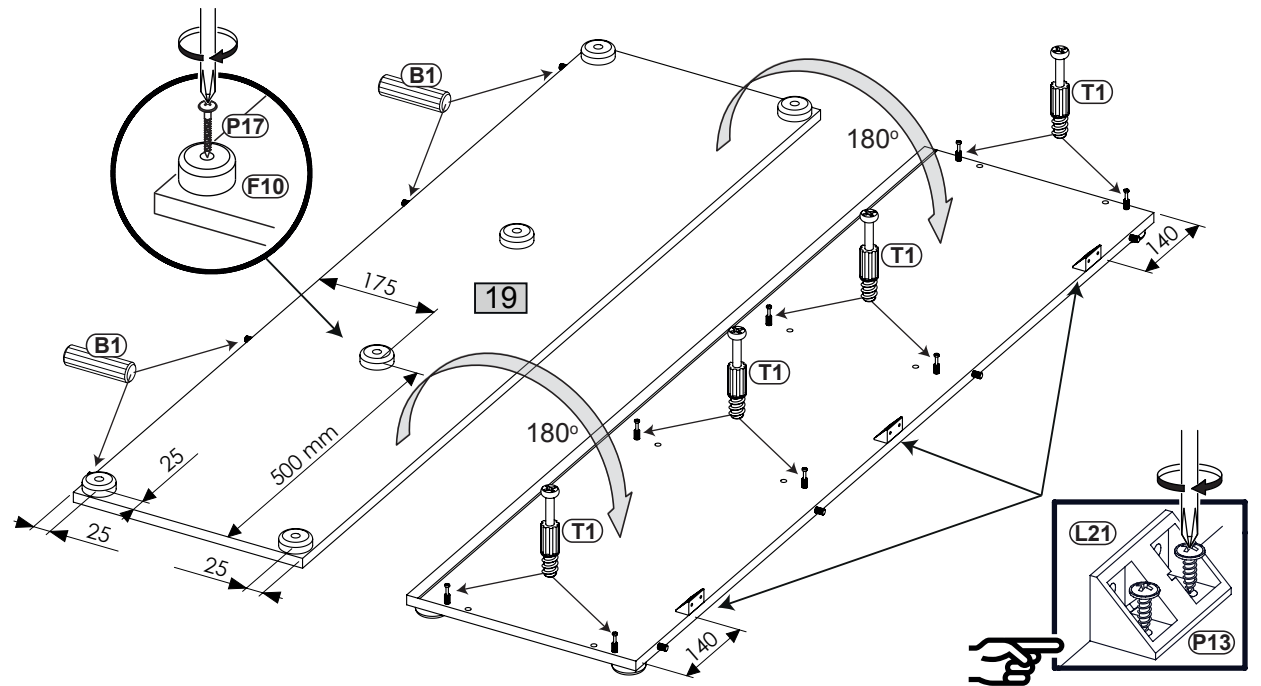
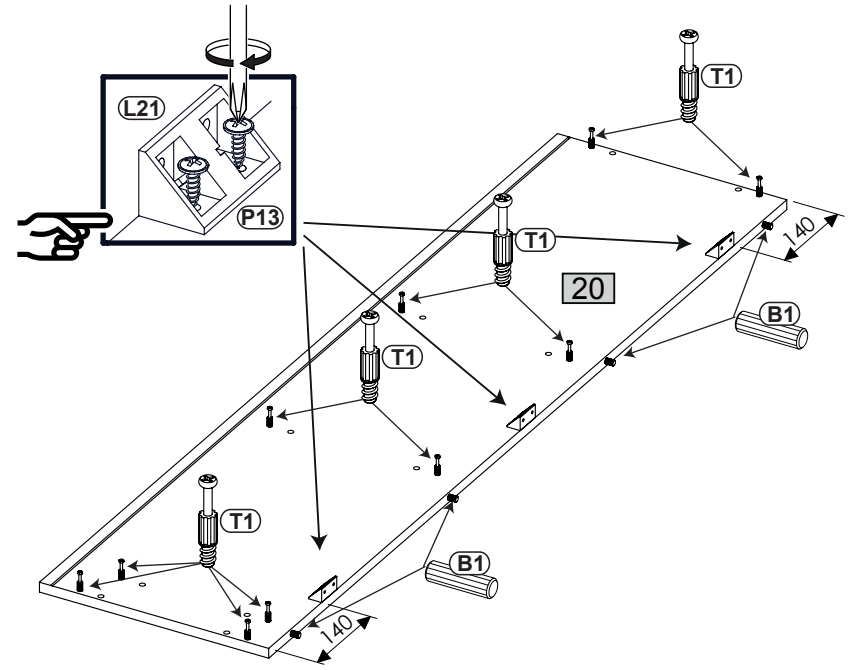
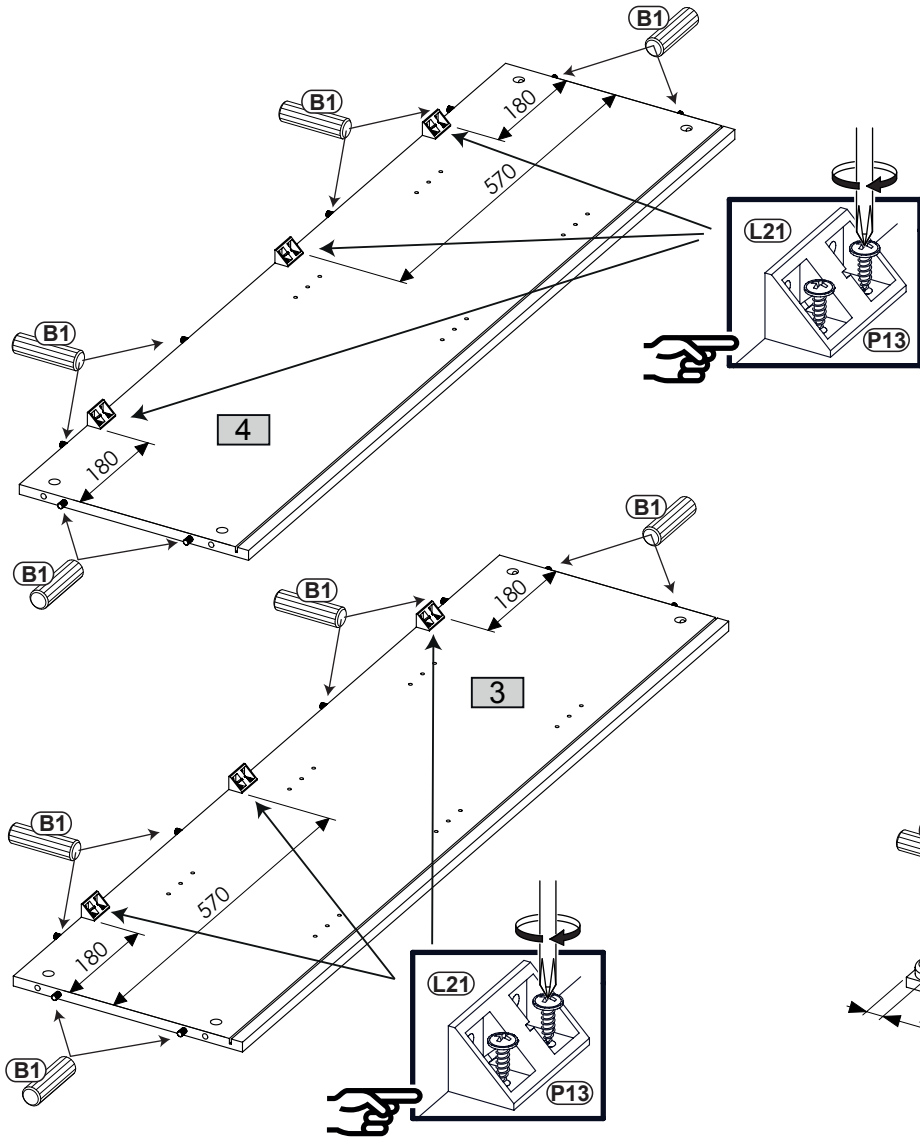
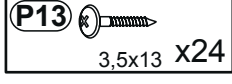
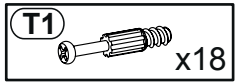
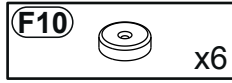
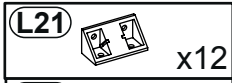
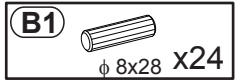

2

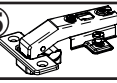

3

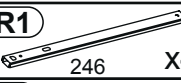
**Z25**  x5  
**S8**  4x13 x10

**R1**  246 x4  
**E4**  6,0x8 x8

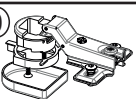
**X9**  x2

**B1**   $\phi$  8x28 x18

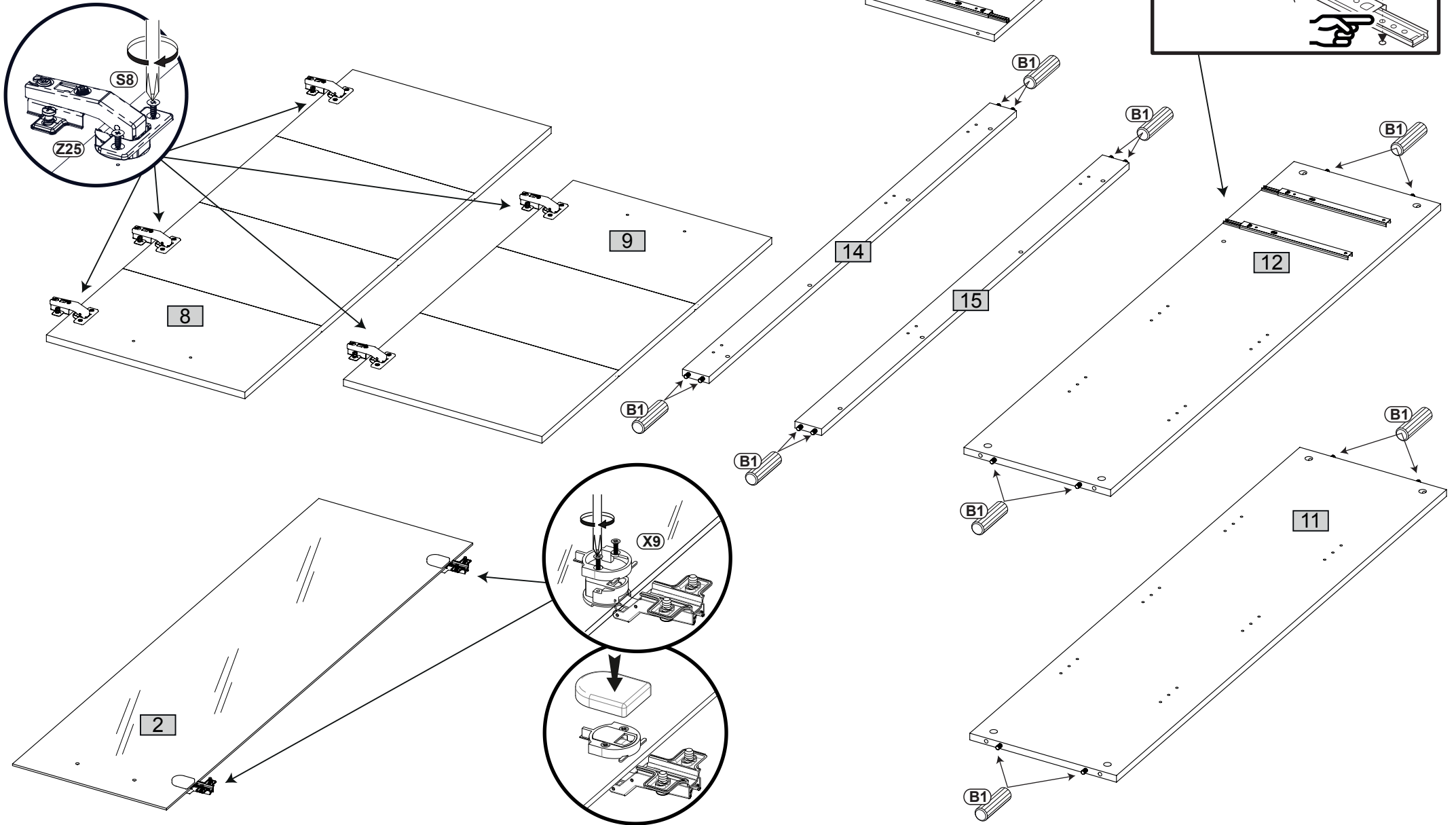

4

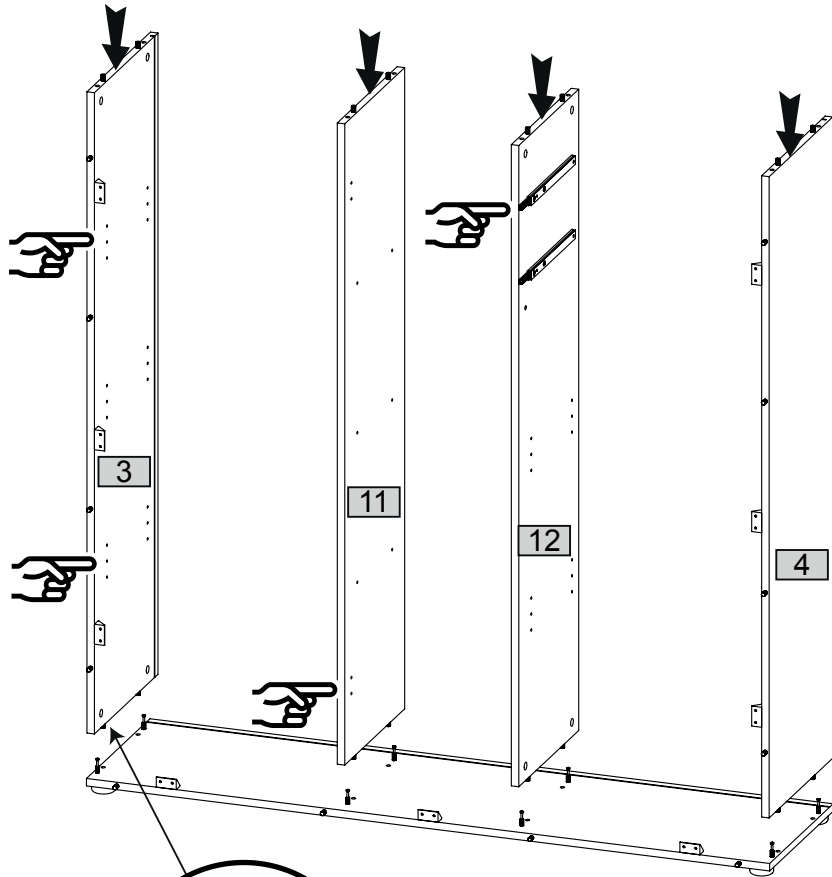

5

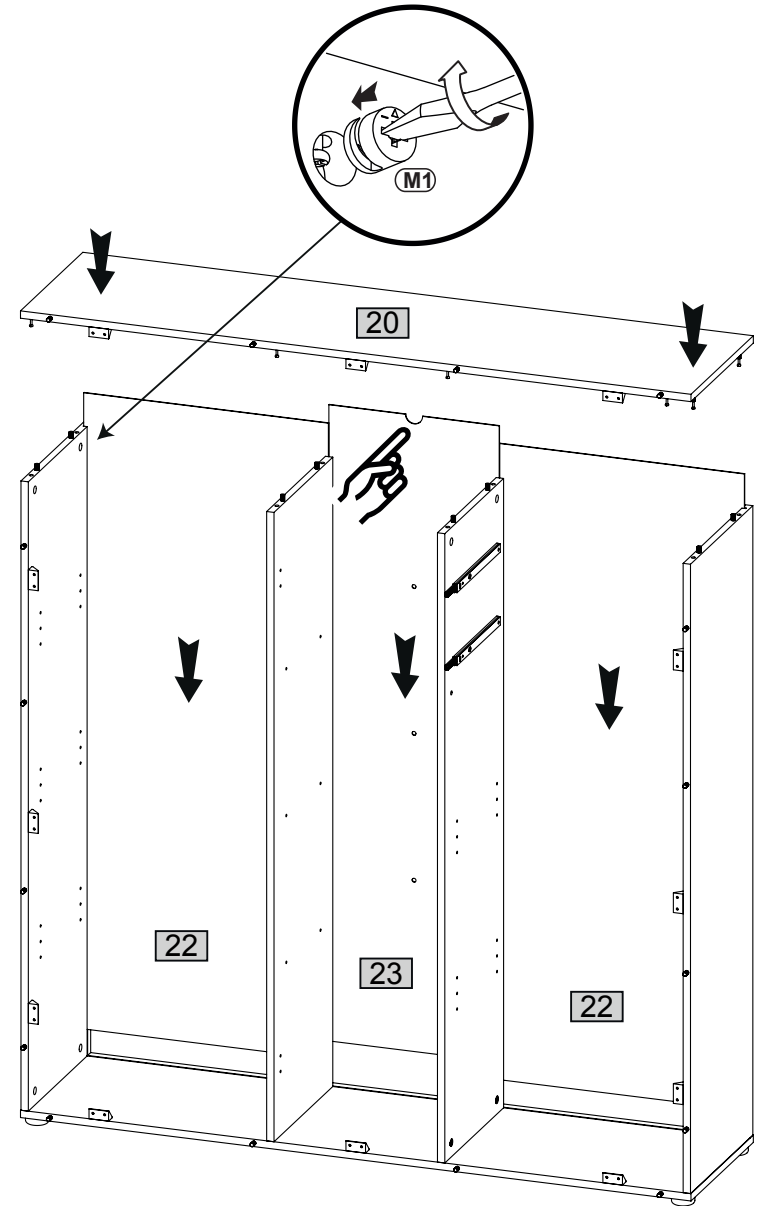

6

**P13**  3,5x13 X24

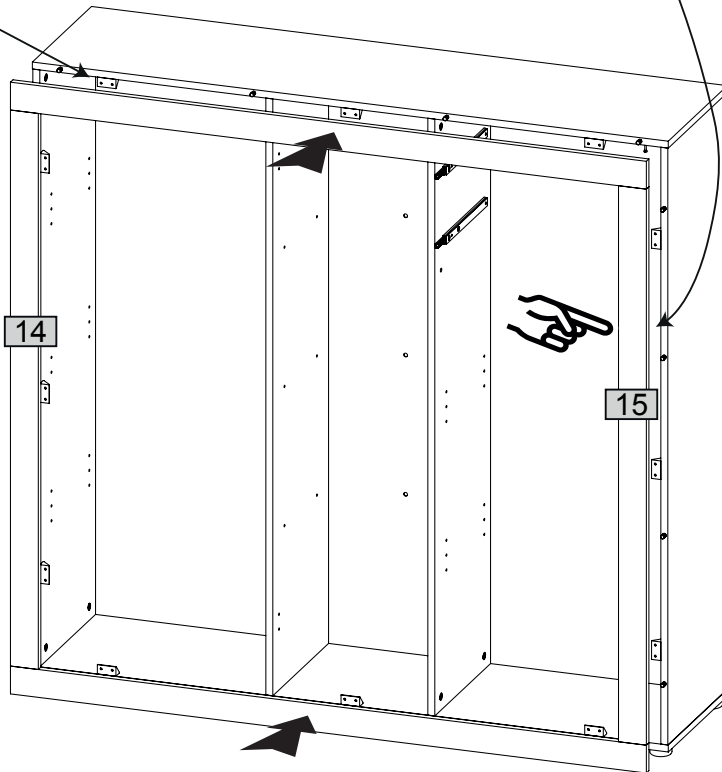
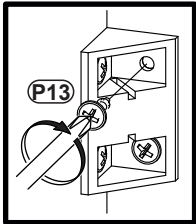
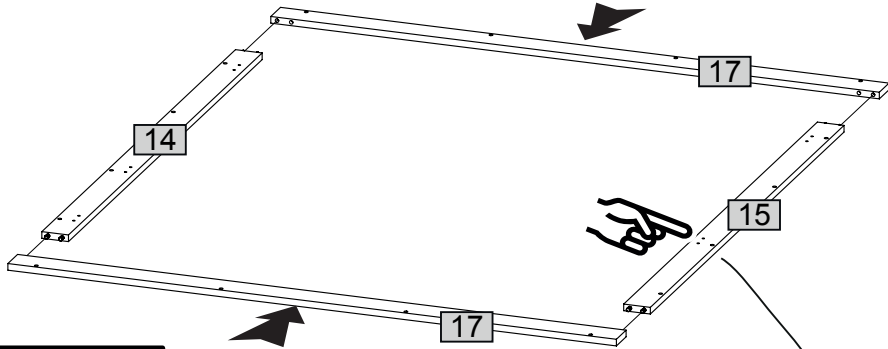

7

**M1**  x2

**K1**  7x50 x2

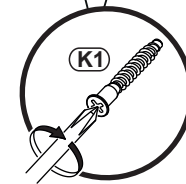
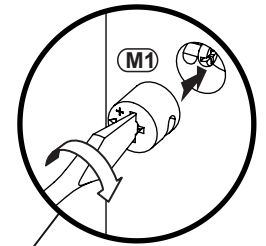
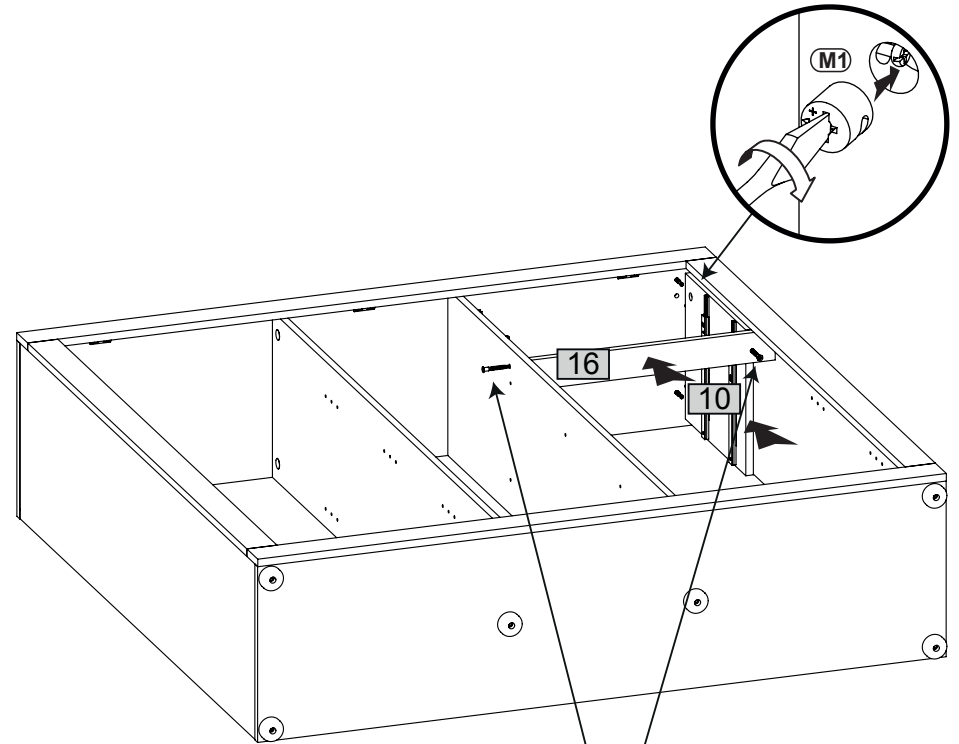

9

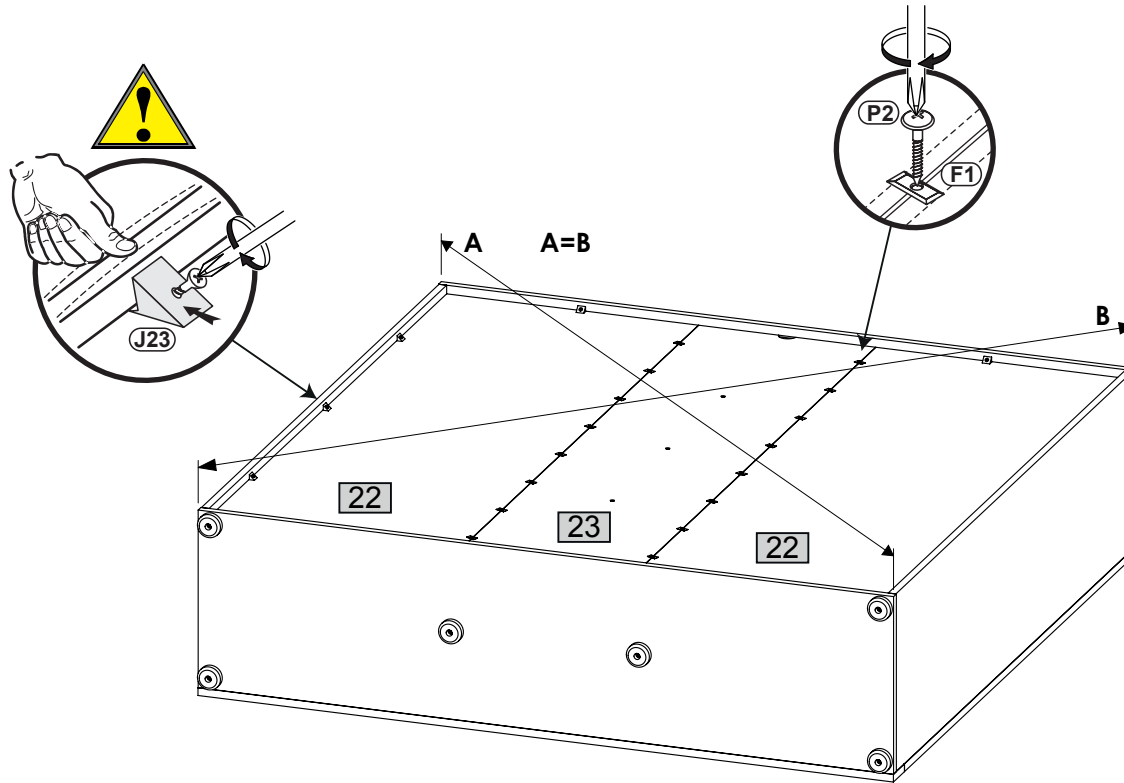
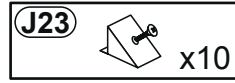
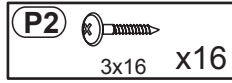
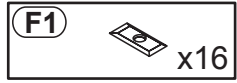



10

