

<http://www.bega-gruppe.de>

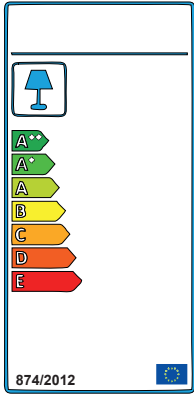

BG	Bulgarisch	български
CS	Tschechisch	čeština
DA	Dänisch	Dansk
DE	Deutsch	Deutsch
ET	Estonisch	Eesti
EL	Griechisch	ελληνικά
EN	Englisch	English
ES	Spanisch	español
FR	Französisch	Français
FI	Finnisch	suomalainen
HR	Kroatisch	hrvatski
HU	Ungarisch	magyar
IT	Italienisch	Italiano
LV	Lettisch	Latvijas
LT	Litauisch	Lietuvos
NL	Niederländisch	Nederlands
PL	Polnisch	Polski
PT	Portugiesisch	português
RO	Rumänisch	român
SK	Slowakisch	slovenský
SL	Slowenisch	slovenščina
SV	Schwedisch	Svenska

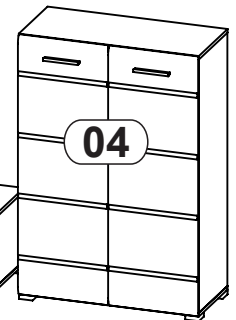

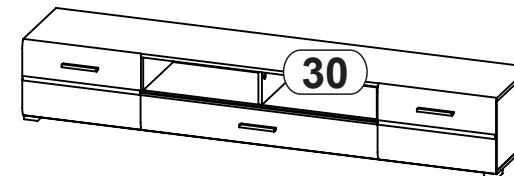
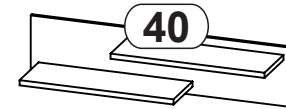
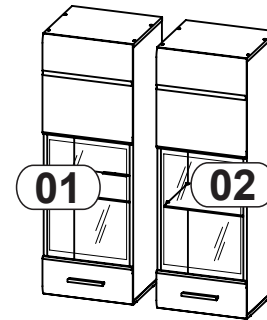
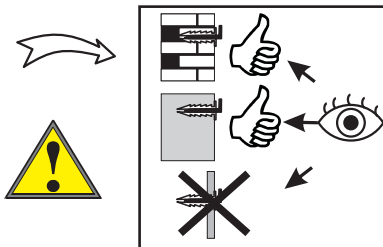
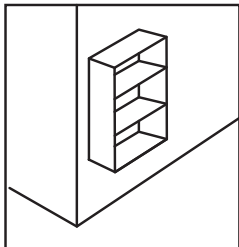
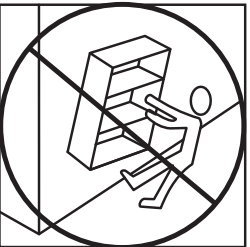
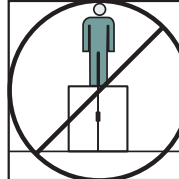
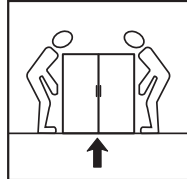
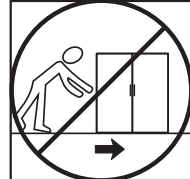
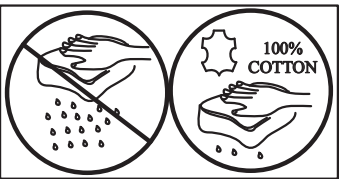
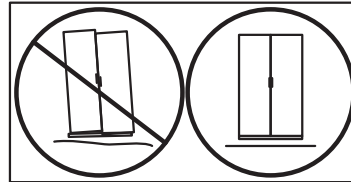
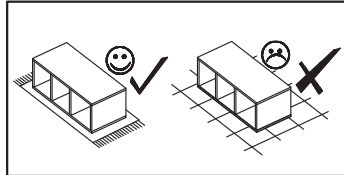
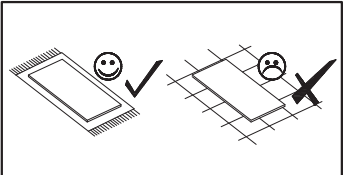
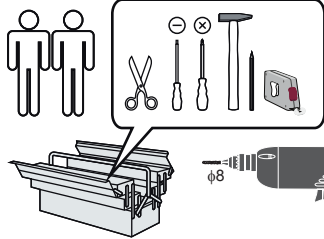
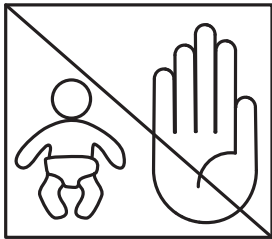
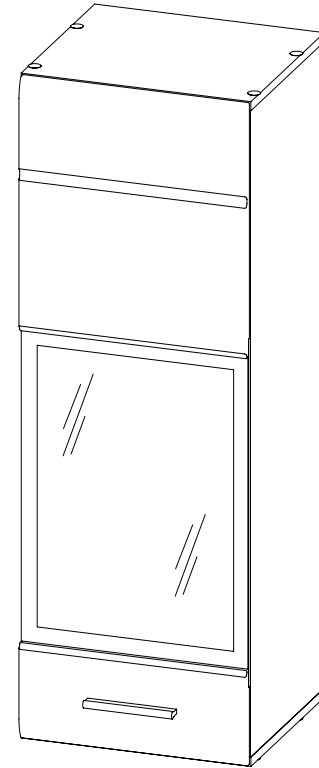
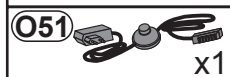
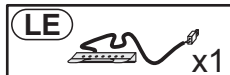
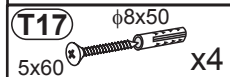
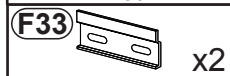
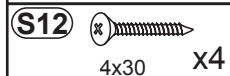
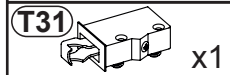
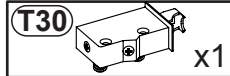
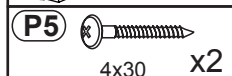
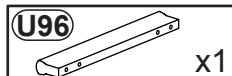
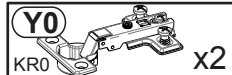
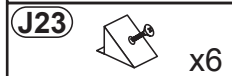
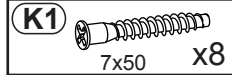
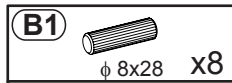



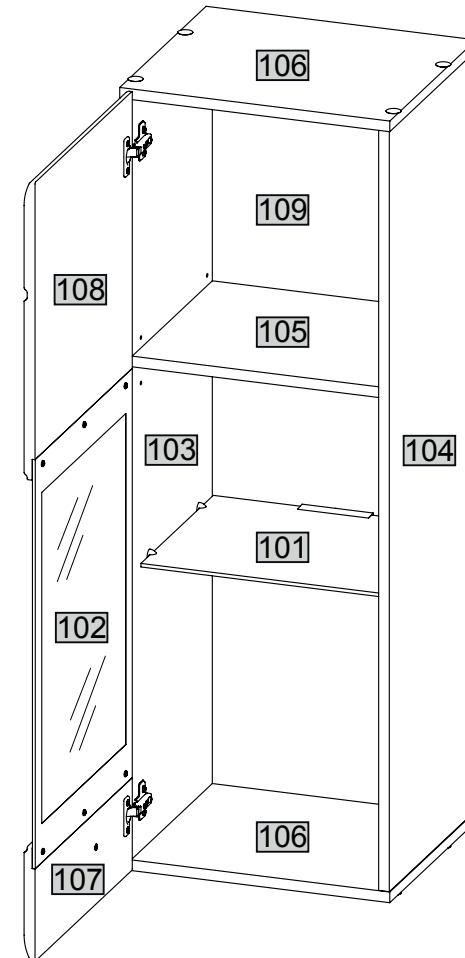

Nr	Ausmaß			St
101	342	280	5	1
102	576	375	4	1
103	1070	333	15	1
104	1070	333	15	1
105	348	310	15	1
106	380	334	15	2
107	160	376	16	1
108	420	376	16	1
109	1084	362	2	1

colli 3/5





1

Y0  x2
S8  x4

G4  x6
P2  x6

B1  ϕ 8x28 x8

T30  x1

T31  x1

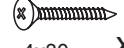
S12  x4

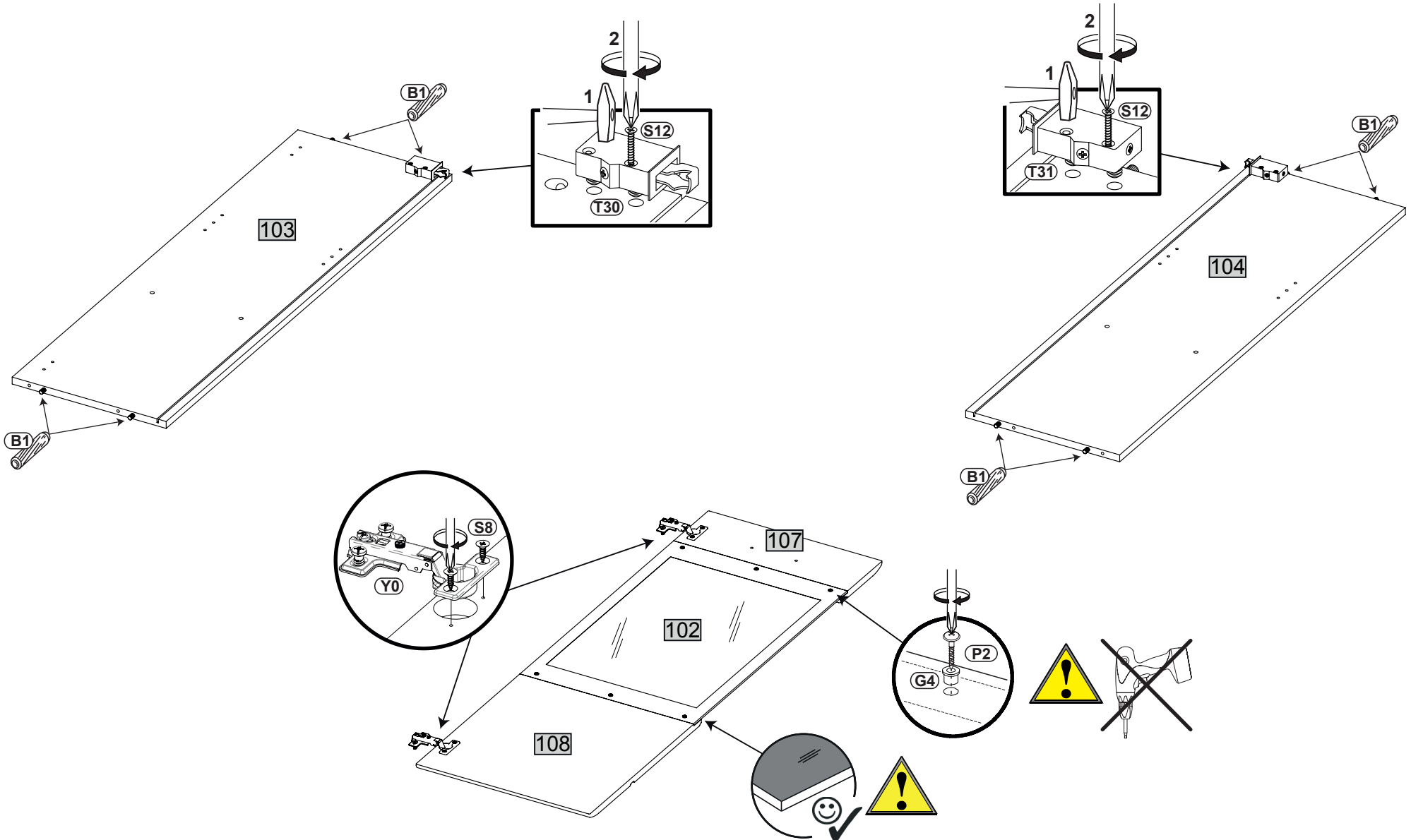

2

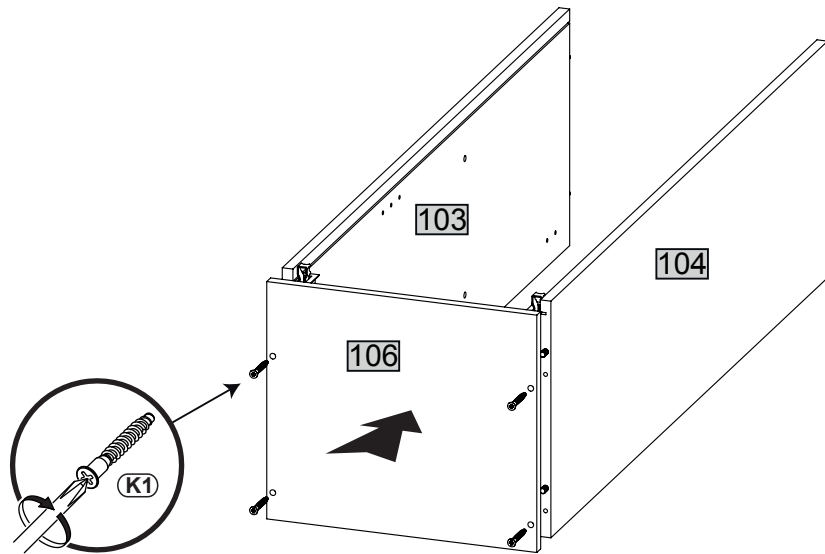
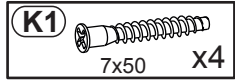

3

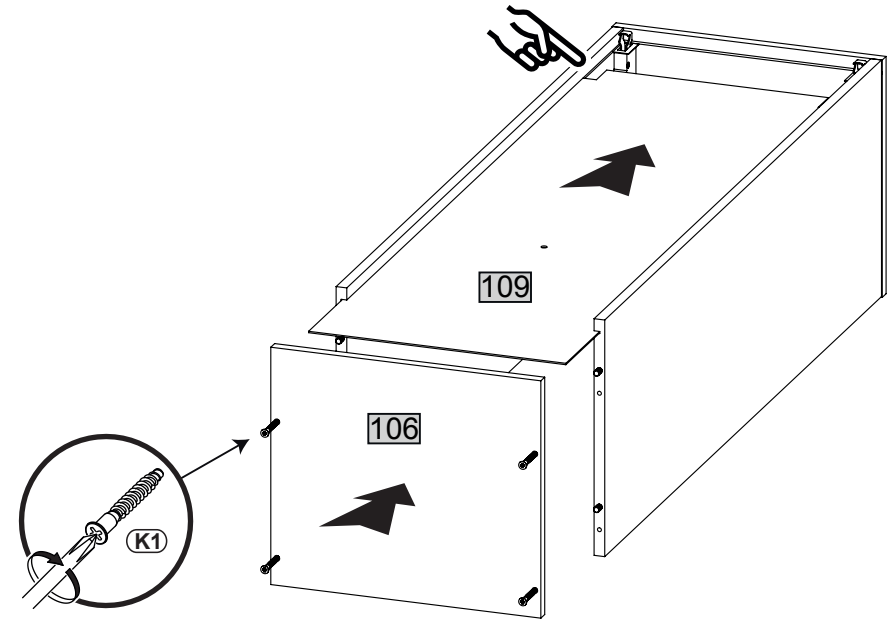
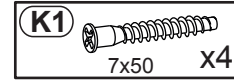

4

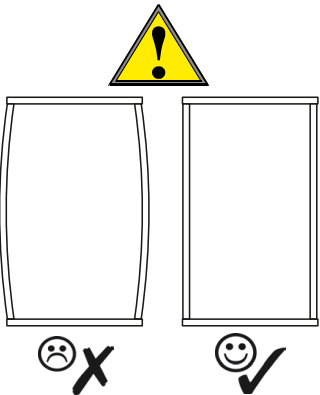
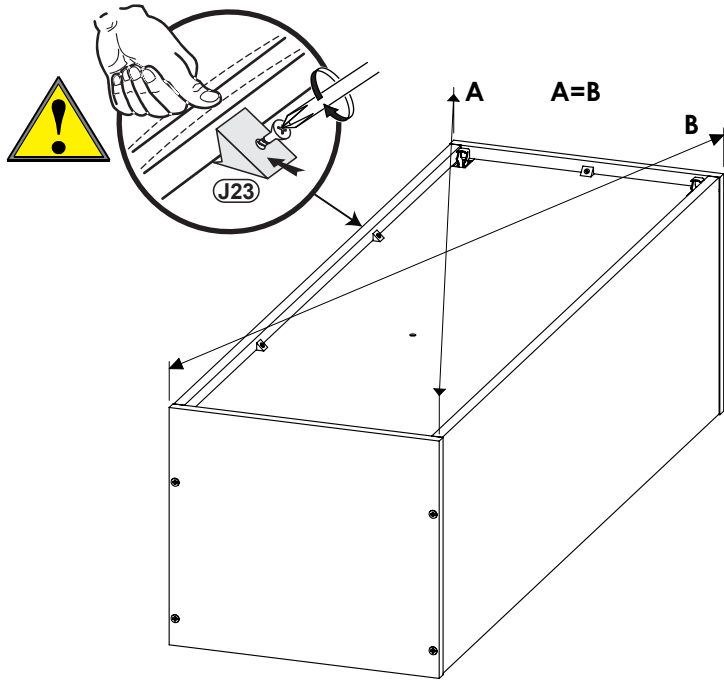
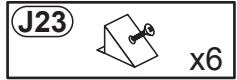

5

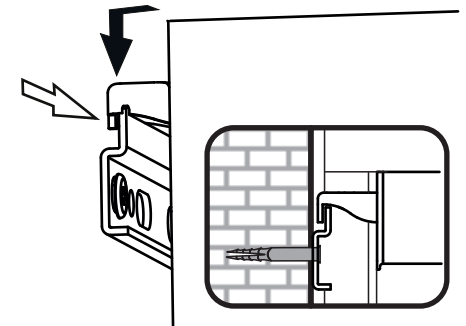
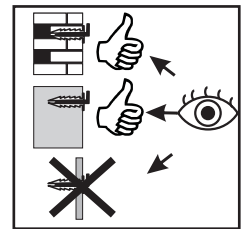
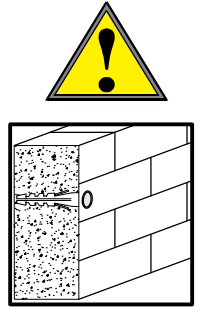
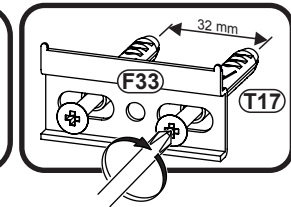
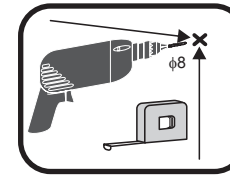
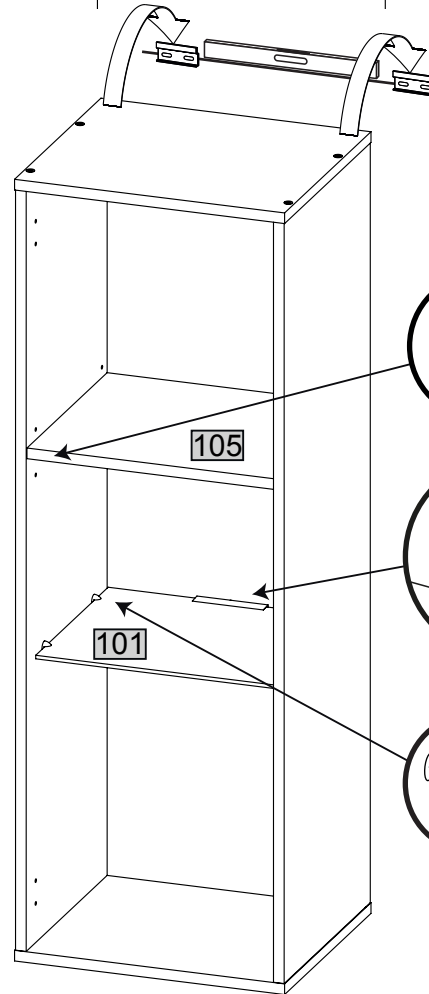
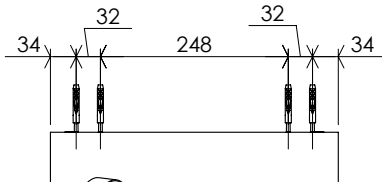
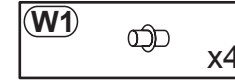
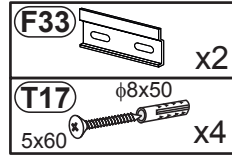

6

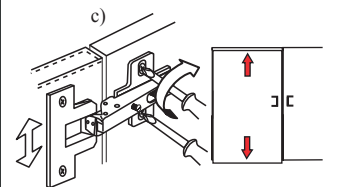
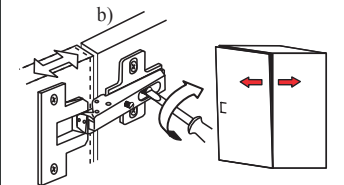
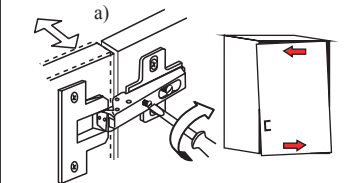
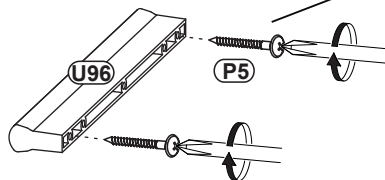
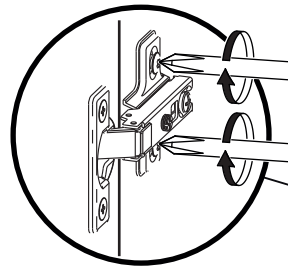
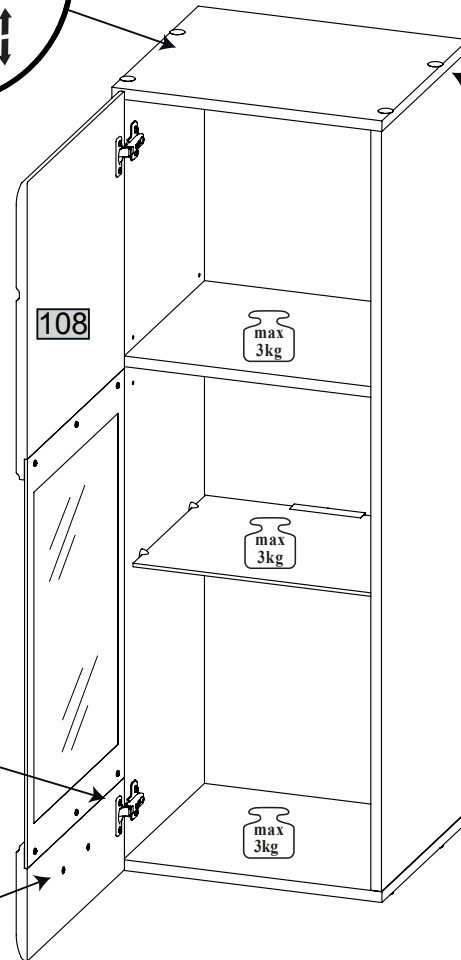
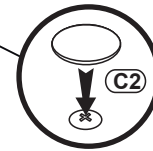
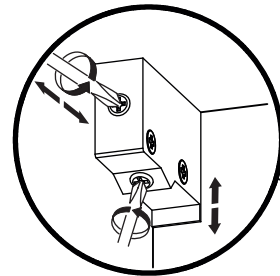
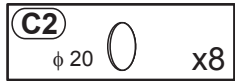
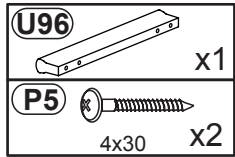

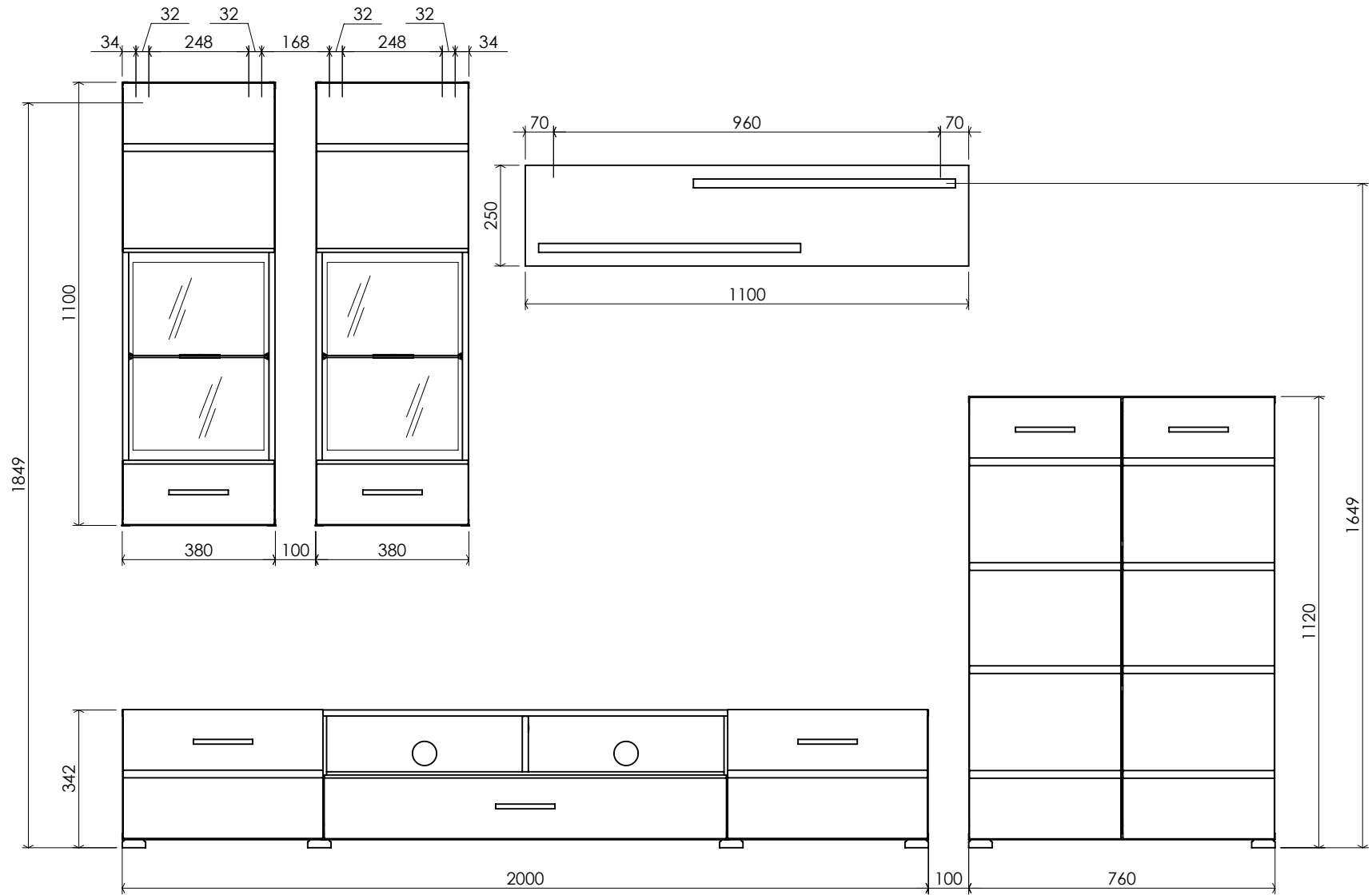

<http://www.bega-gruppe.de>

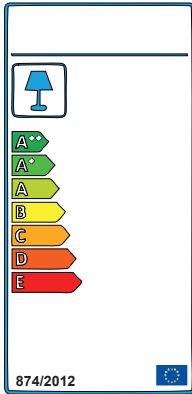

BG	Bulgarisch	български
CS	Tschechisch	čeština
DA	Dänisch	Dansk
DE	Deutsch	Deutsch
ET	Estonisch	Eesti
EL	Griechisch	ελληνικά
EN	Englisch	English
ES	Spanisch	español
FR	Französisch	Français
FI	Finnisch	suomalainen
HR	Kroatisch	hrvatski
HU	Ungarisch	magyar
IT	Italienisch	Italiano
LV	Lettisch	Latvijas
LT	Litauisch	Lietuvos
NL	Niederländisch	Nederlands
PL	Polnisch	Polski
PT	Portugiesisch	português
RO	Rumänisch	român
SK	Slowakisch	slovenský
SL	Slowenisch	slovenščina
SV	Schwedisch	Svenska

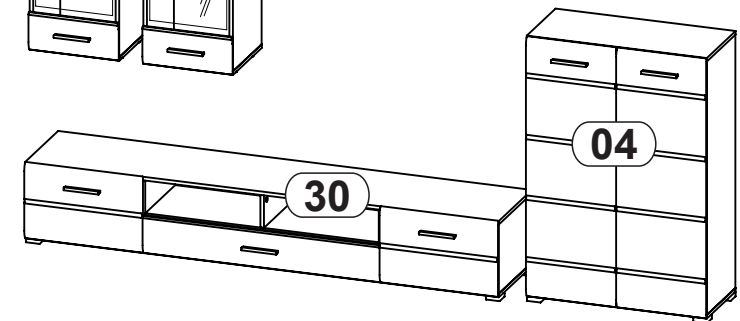
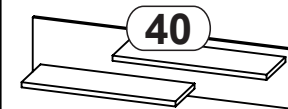
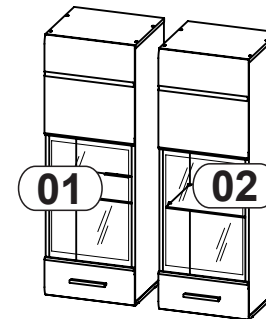
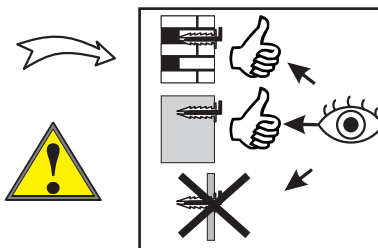
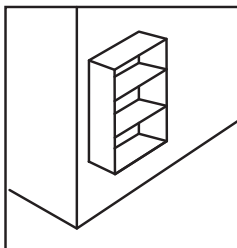
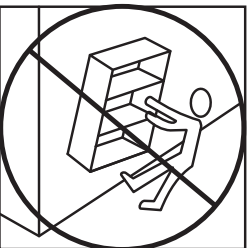
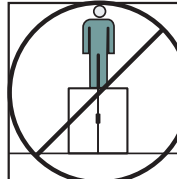
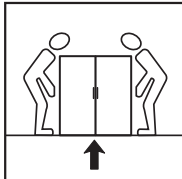
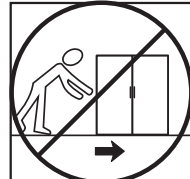
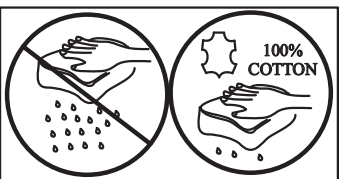
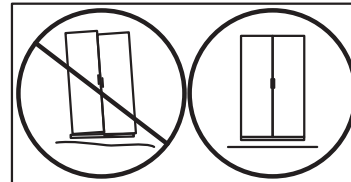
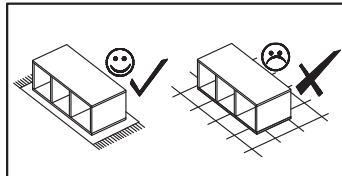
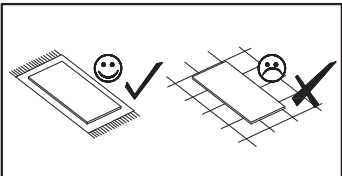
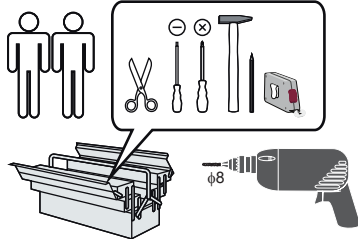
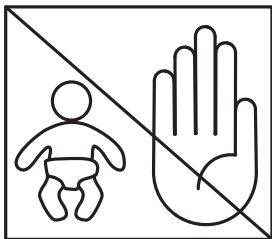
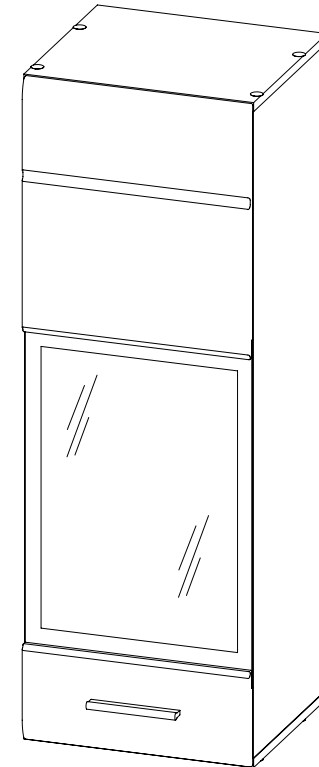

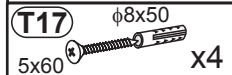
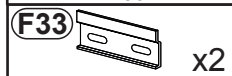
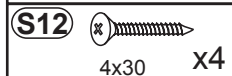
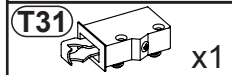
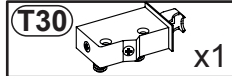
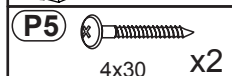
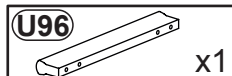
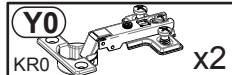
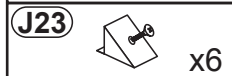
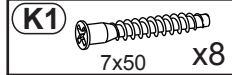
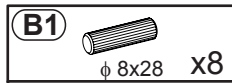

colli 3/5

Nr	Ausmaß			St
101	342	280	5	1
102	576	375	4	1
103	1070	333	15	1
104	1070	333	15	1
105	348	310	15	1
106	380	334	15	2
107	160	376	16	1
108	420	376	16	1
109	1084	362	2	1

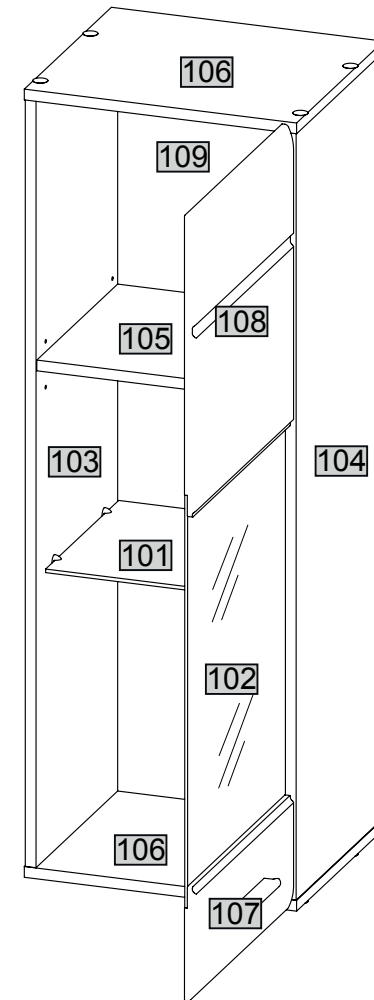

1

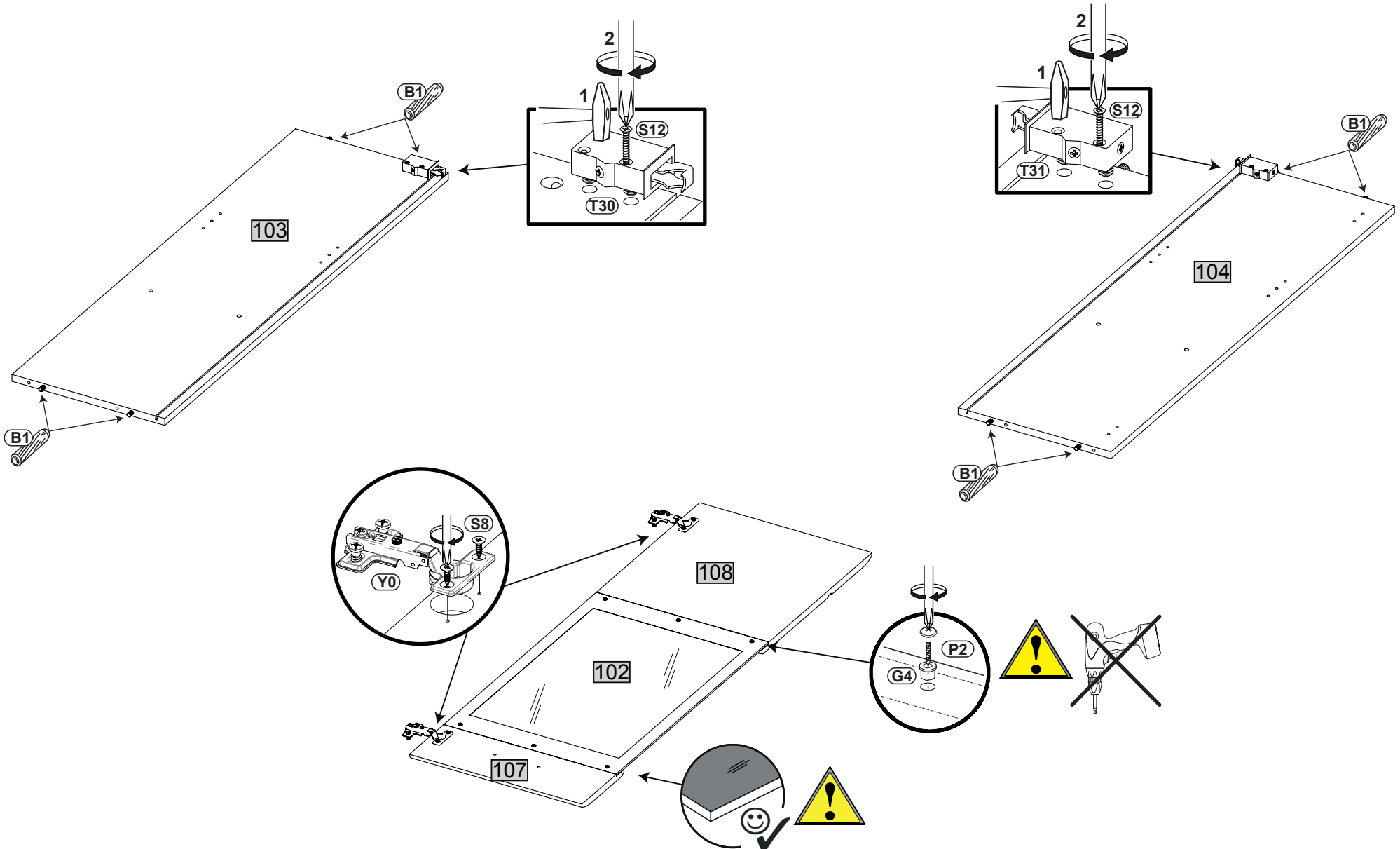
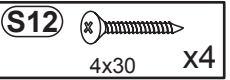
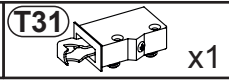
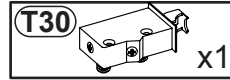
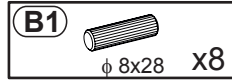
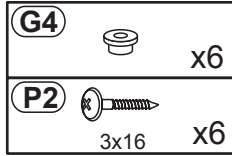
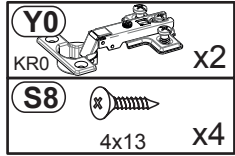

2

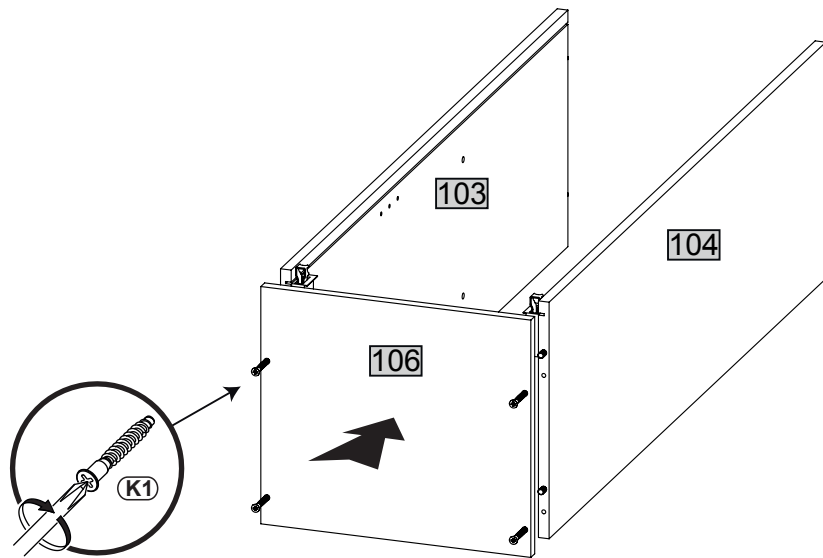
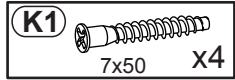

3

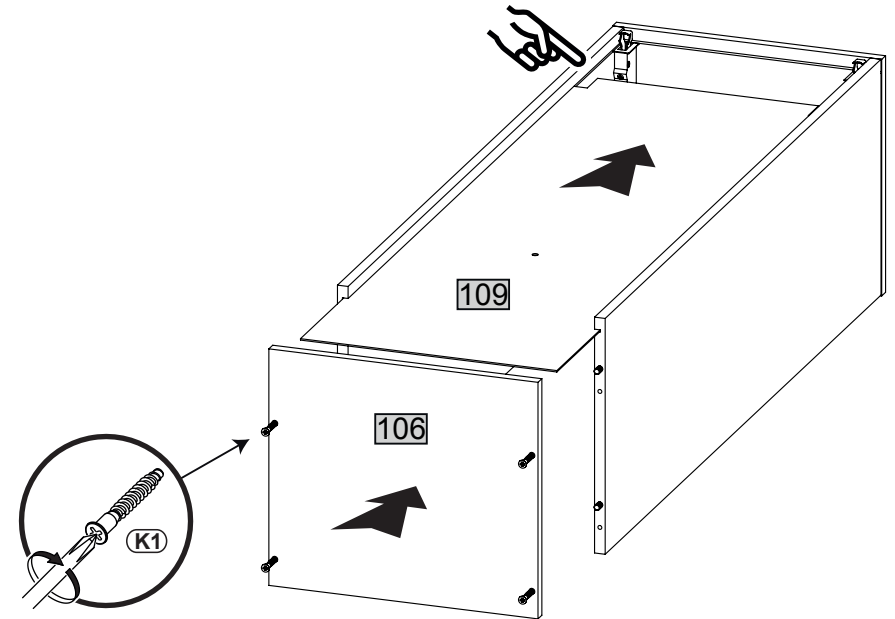
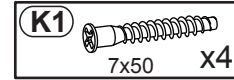

4

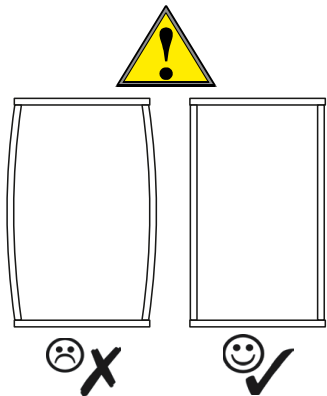
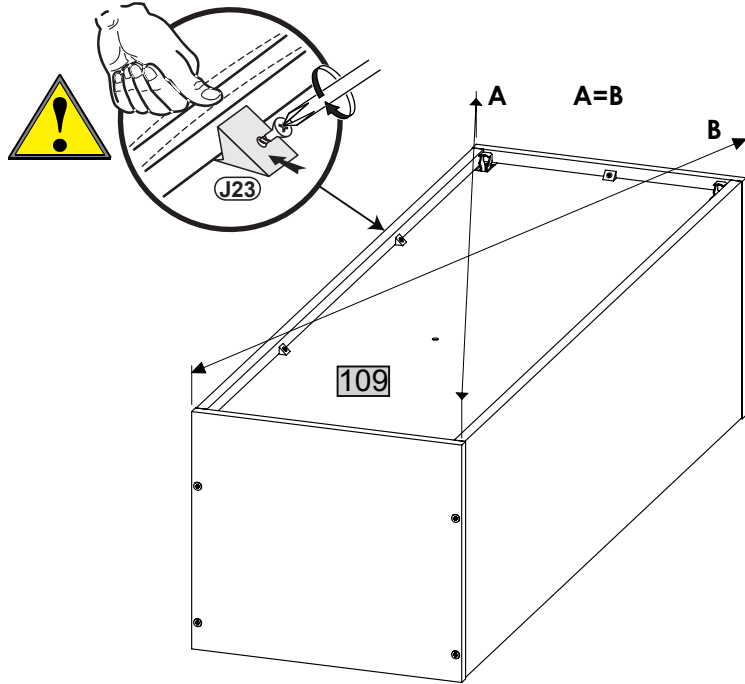
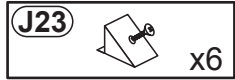

5

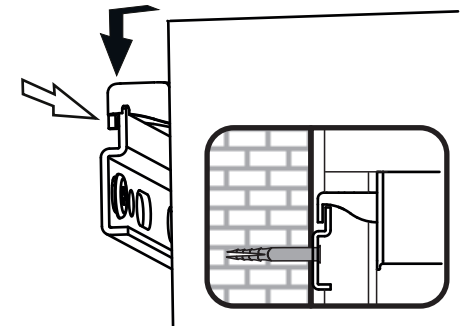
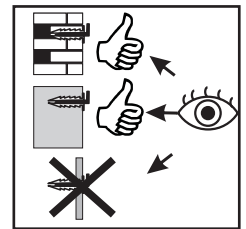
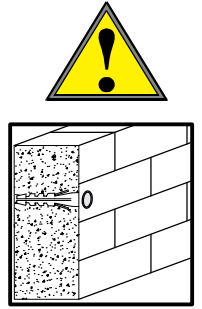
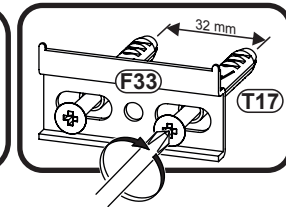
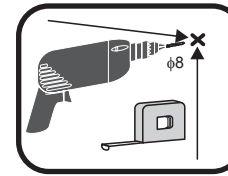
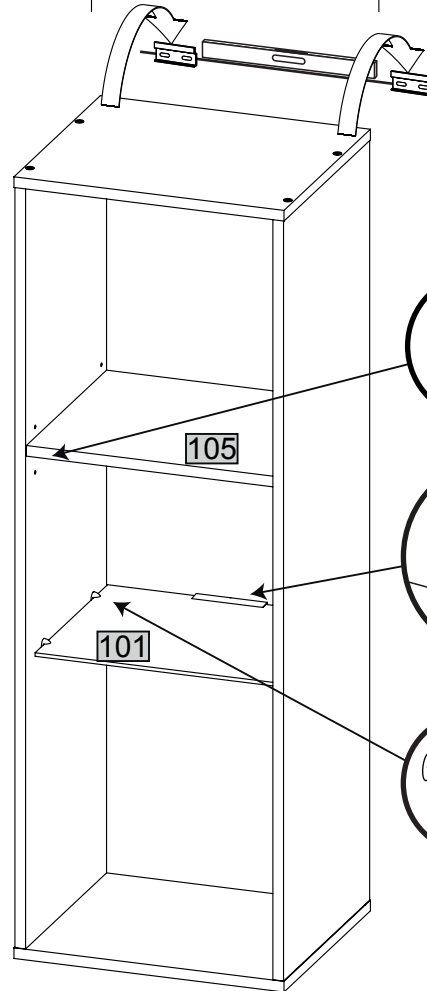
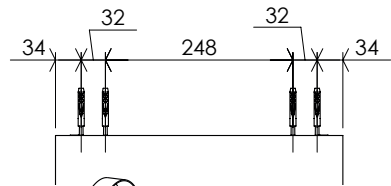
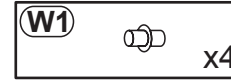
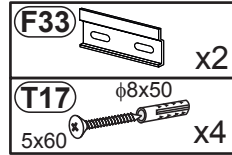

6

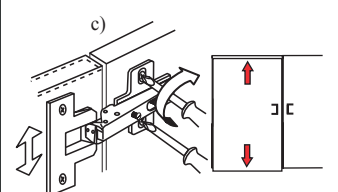
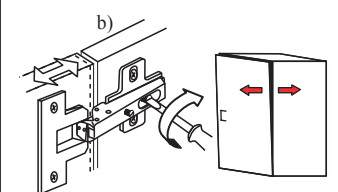
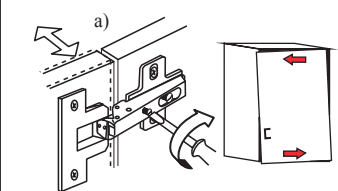
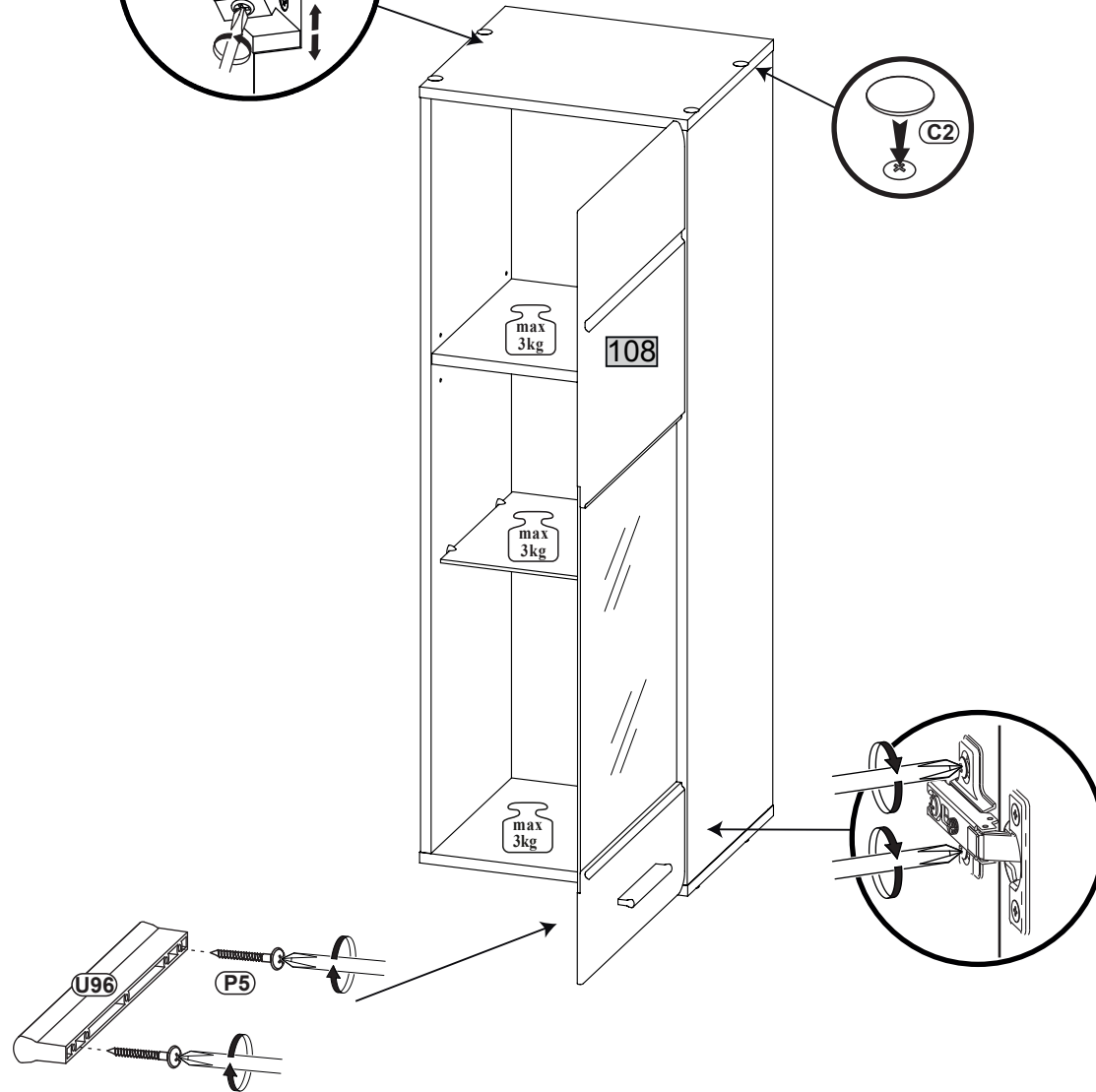
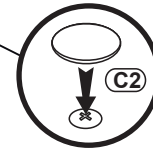
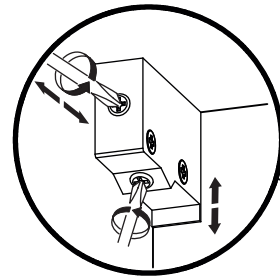
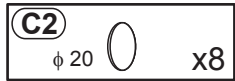
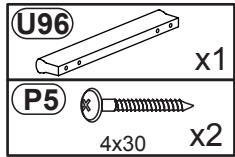

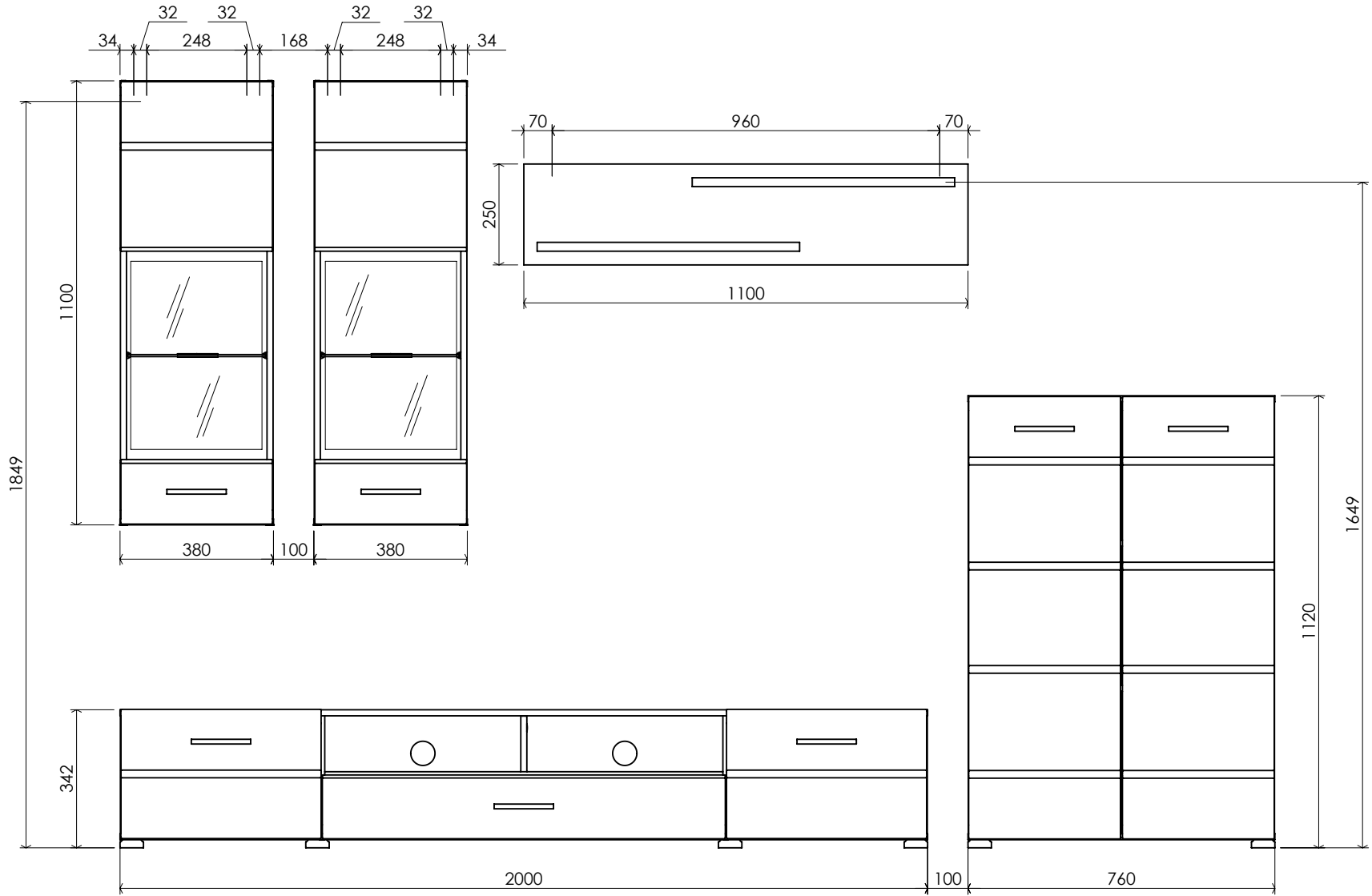

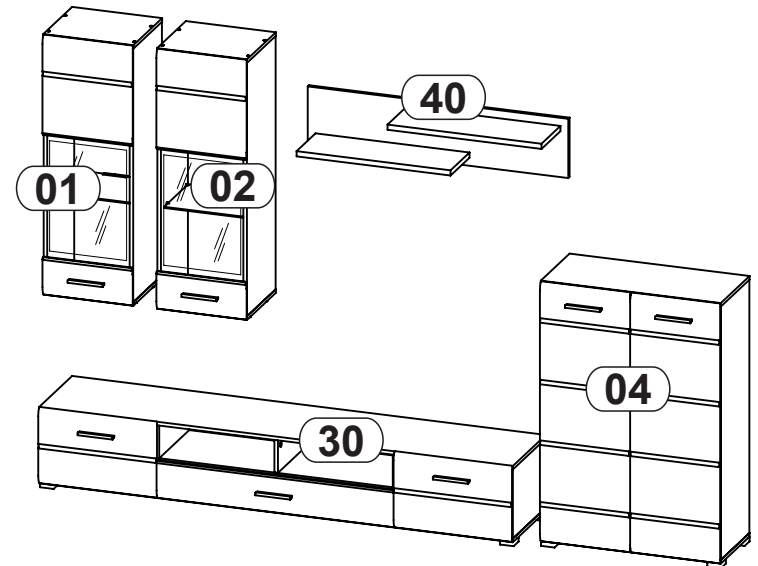
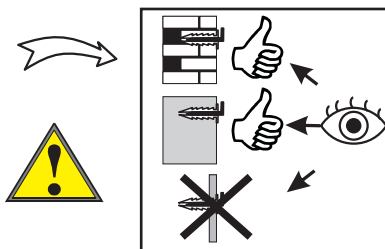
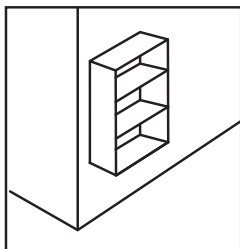
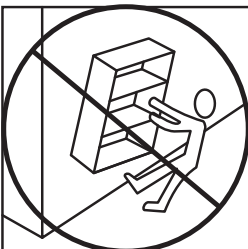
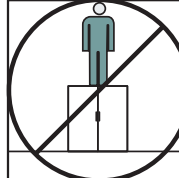
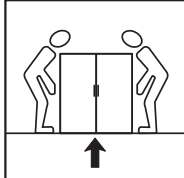
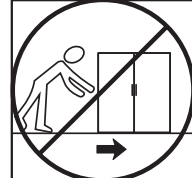
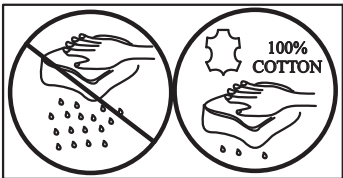
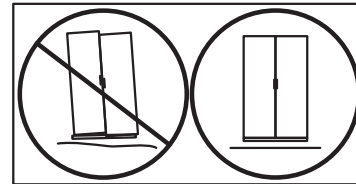
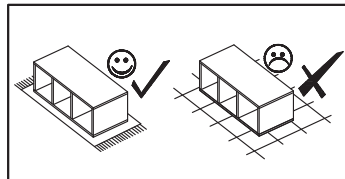
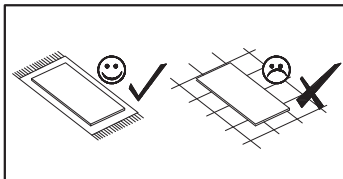
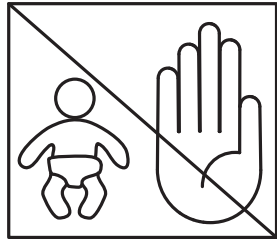
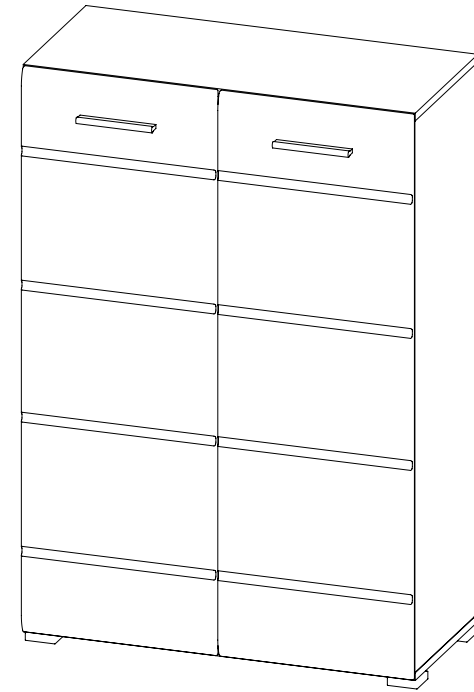
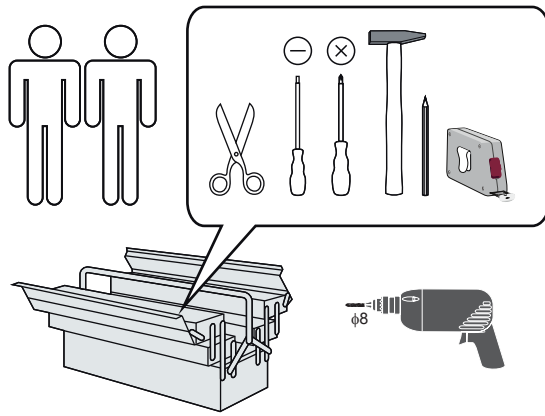

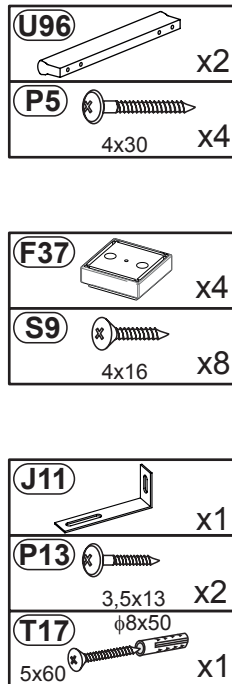
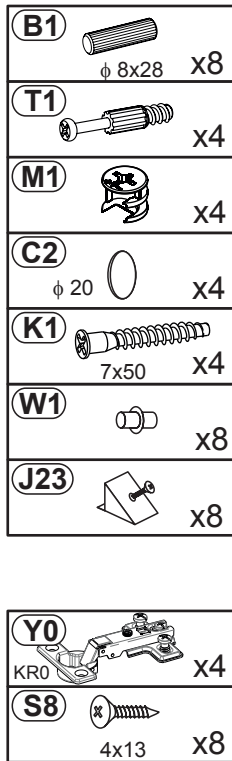

Nr	Ausmaß			St
101	1070	333	15	1
102	1070	333	15	1
103	728	310	15	2
104	760	334	15	1
105	760	334	15	1
106	1096	376	16	1
107	1096	376	16	1
108	1084	370	2	1
109	1084	370	2	1

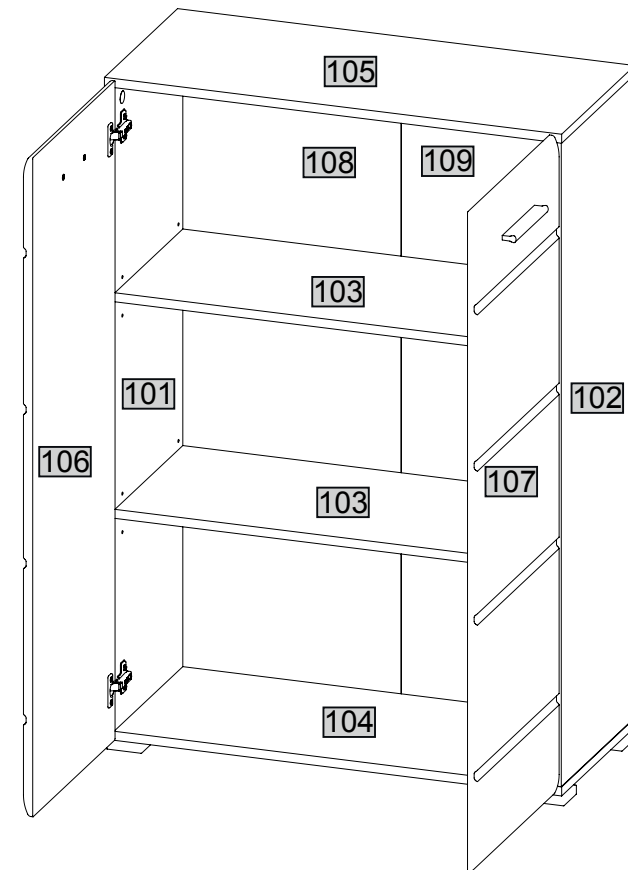

1

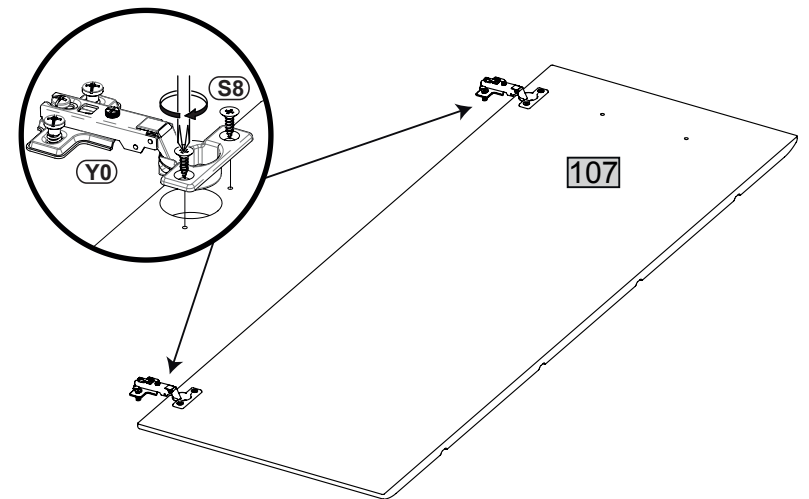
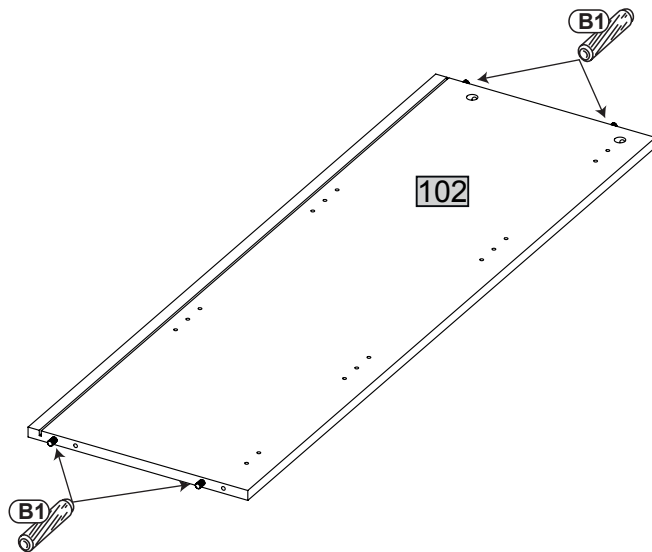
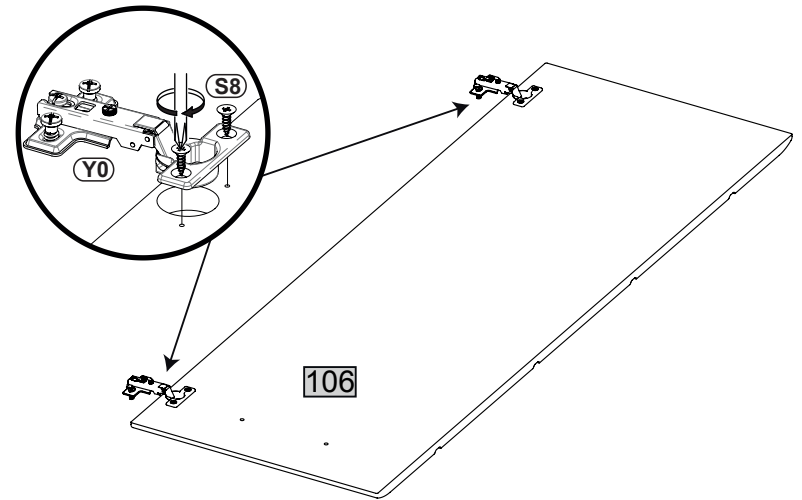
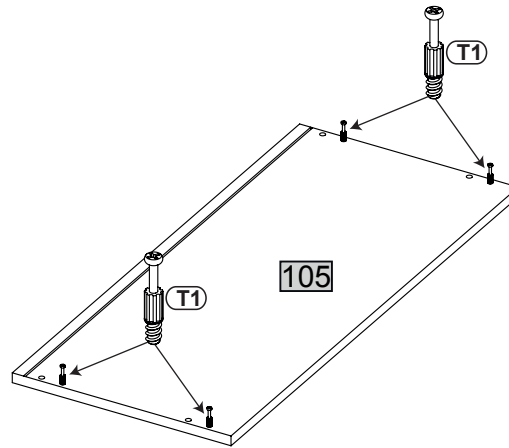
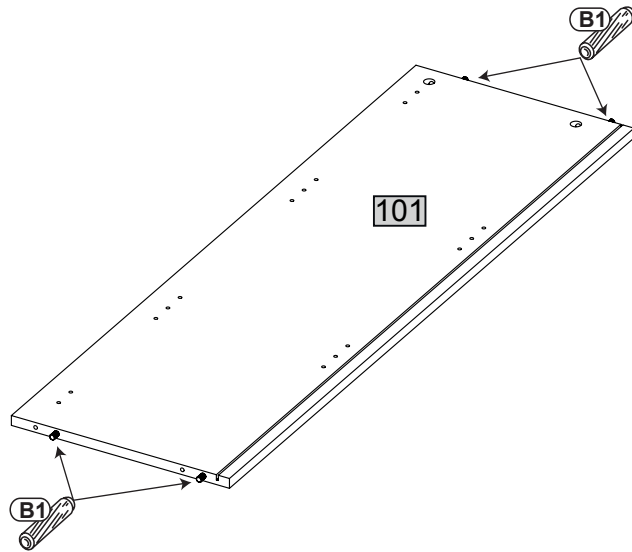
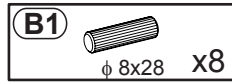
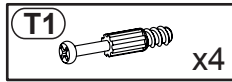
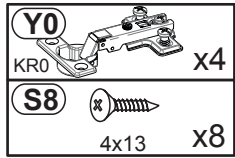

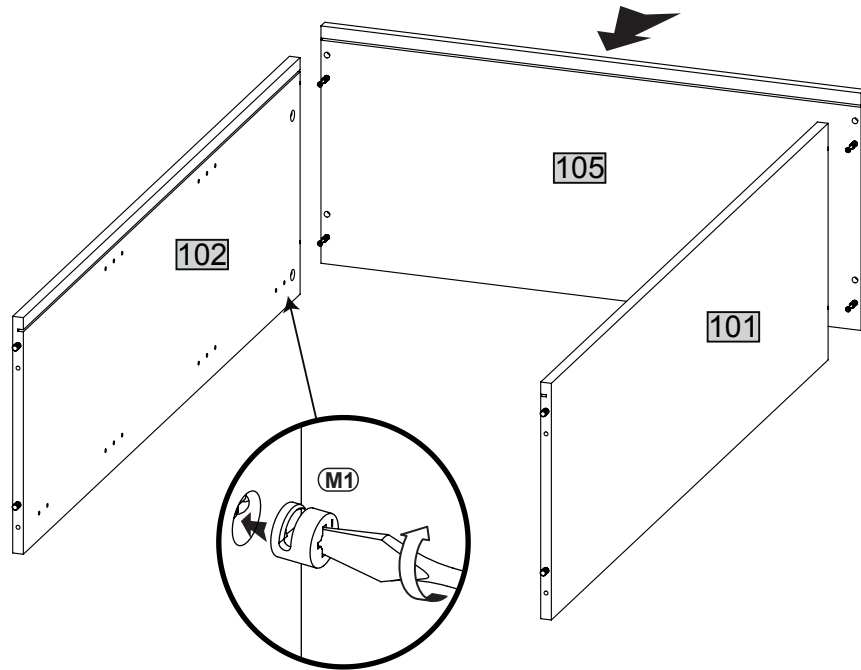

2

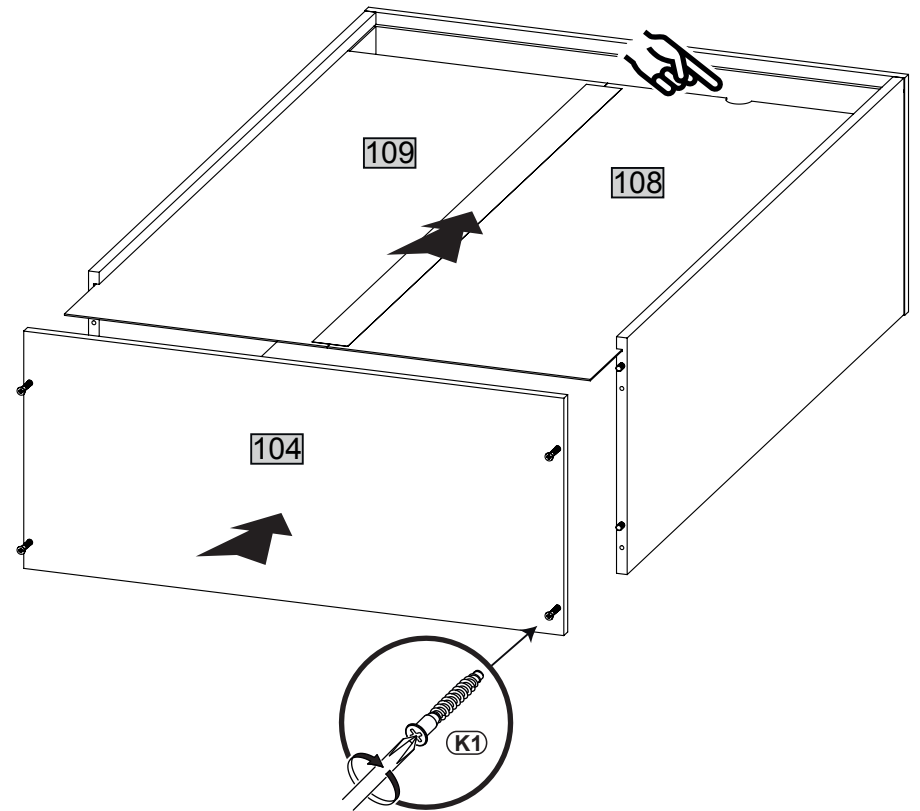
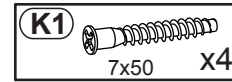

3

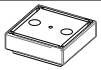

4

F37  x4
S9  4x16 x8

J23  x8

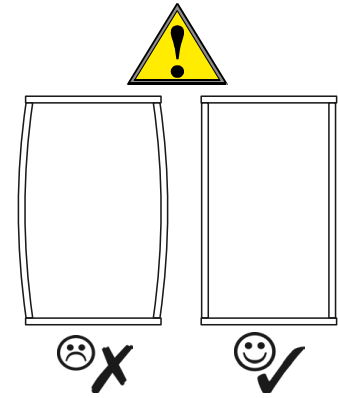
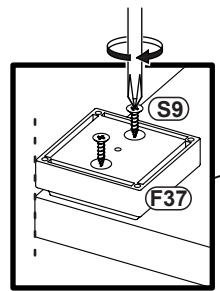
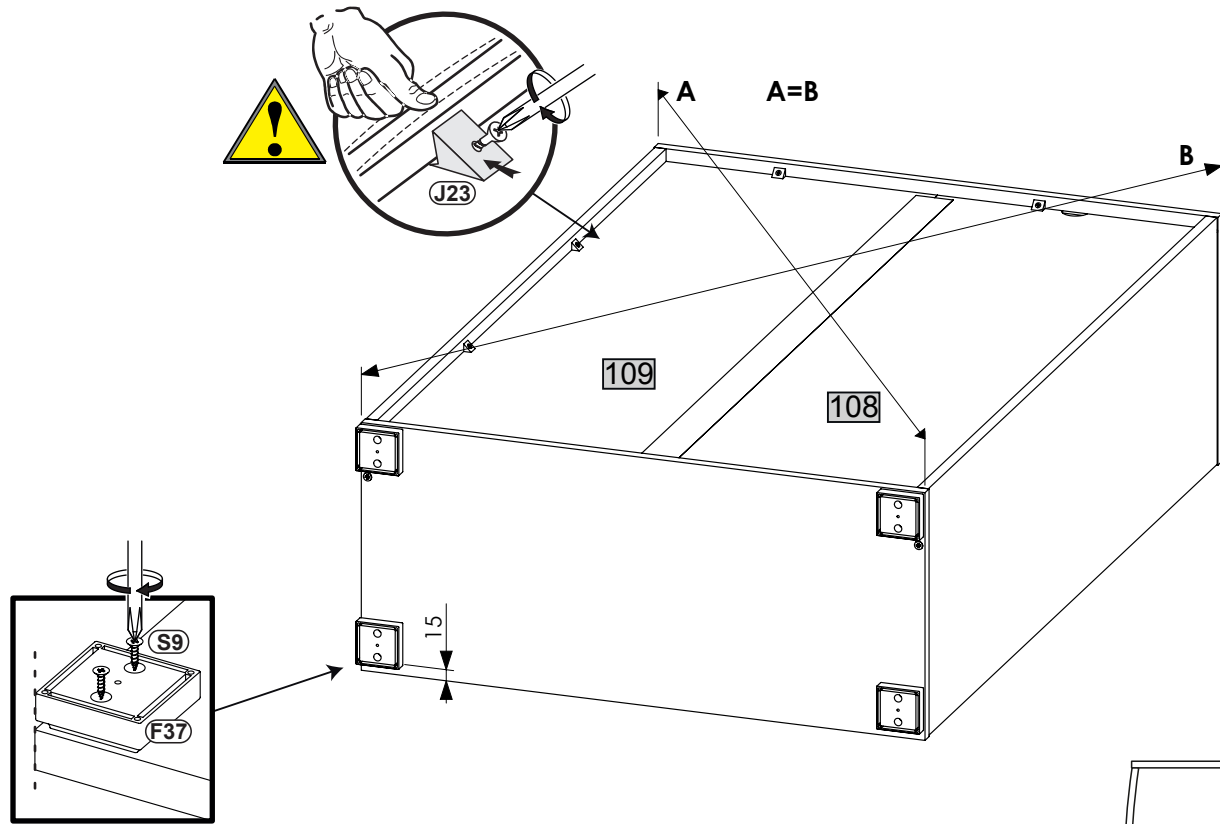

6

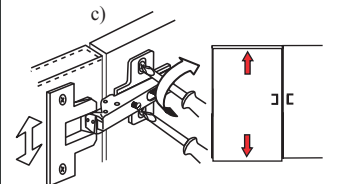
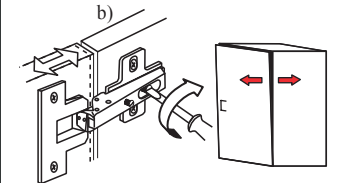
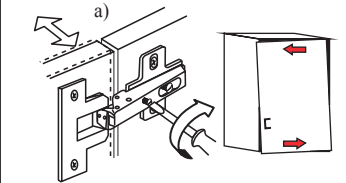
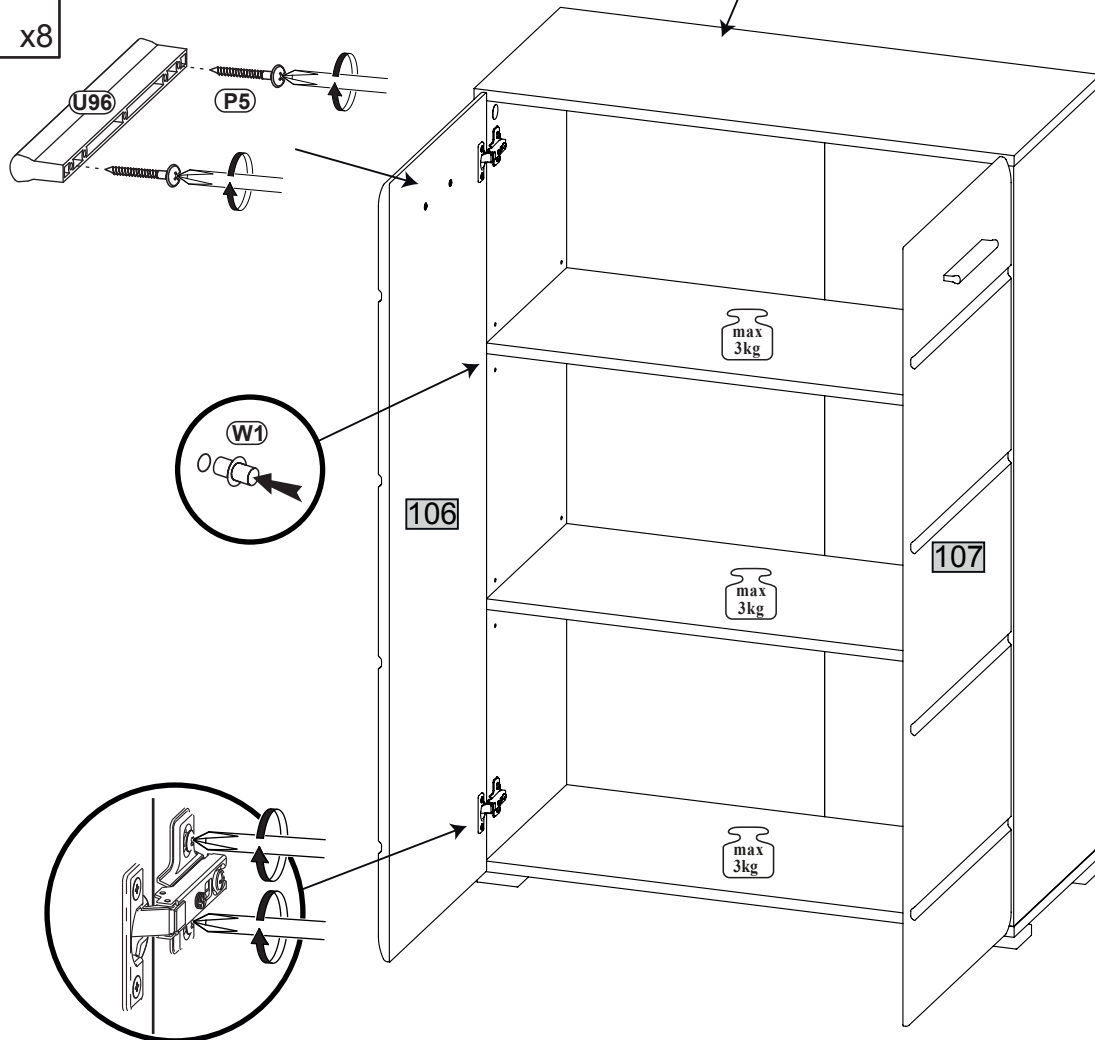
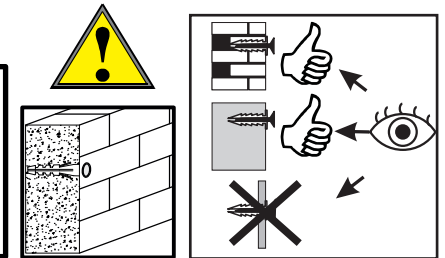
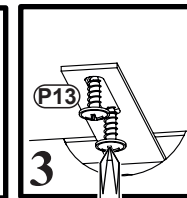
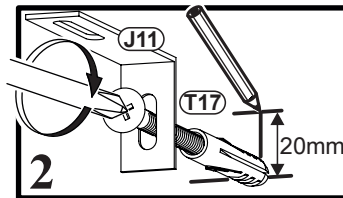
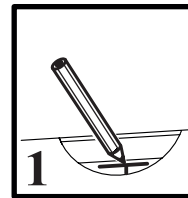
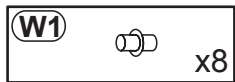
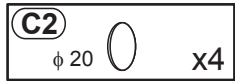
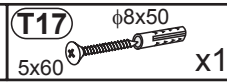
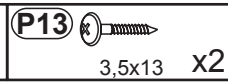
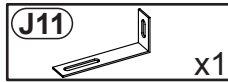
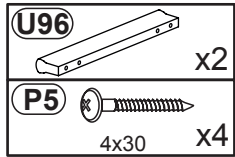

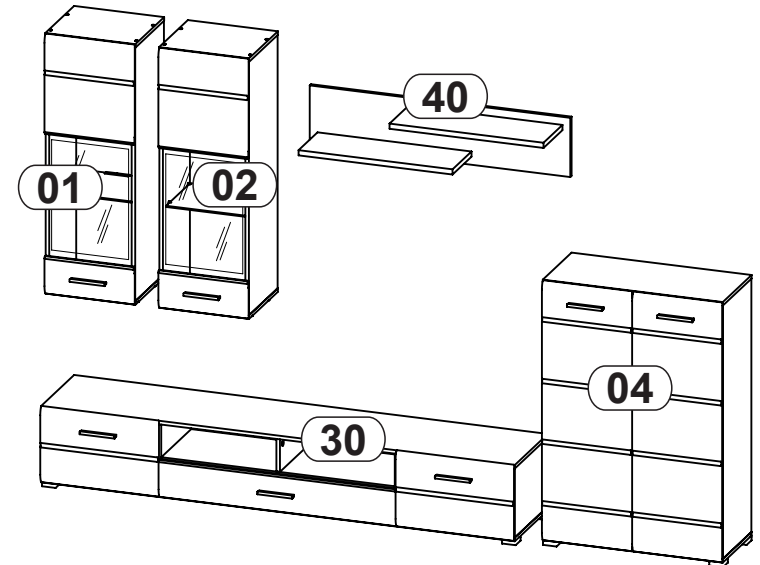
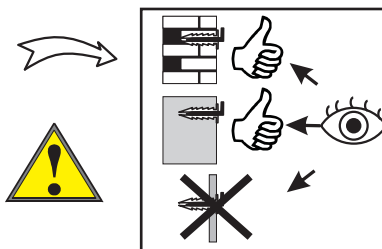
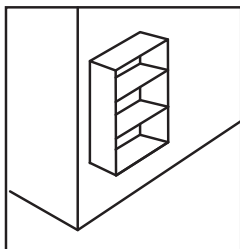
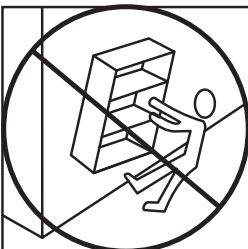
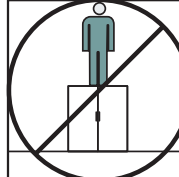
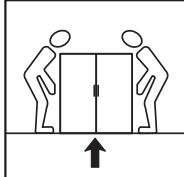
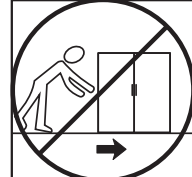
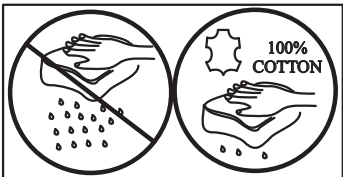
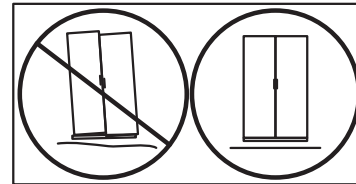
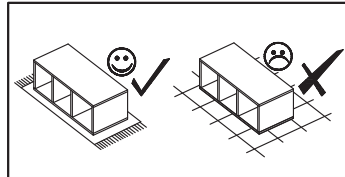
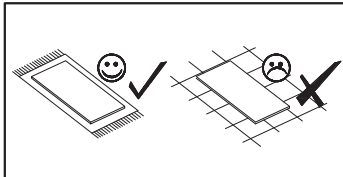
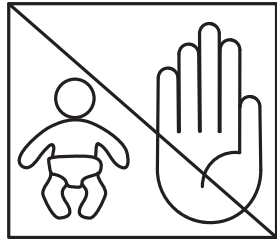
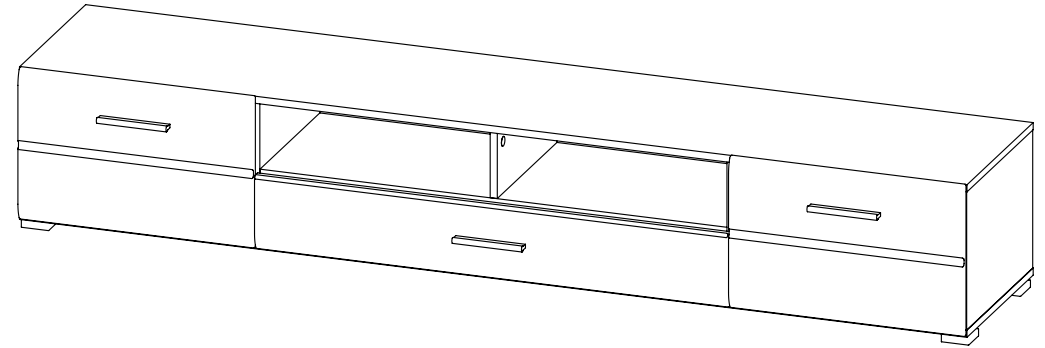
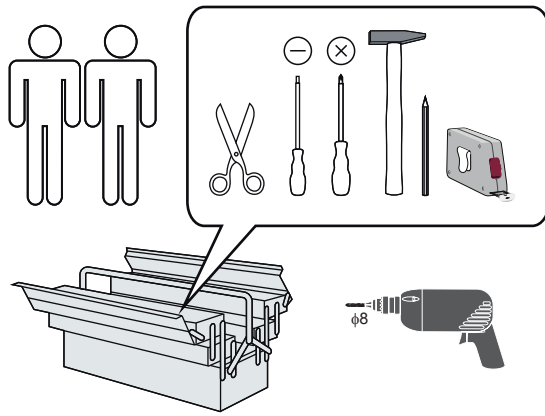

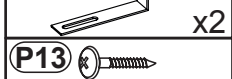
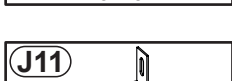
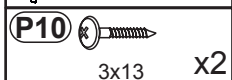
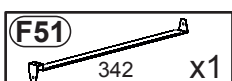
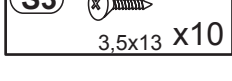
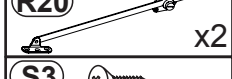
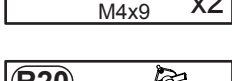
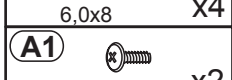
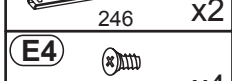
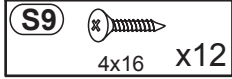
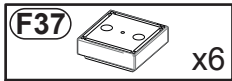
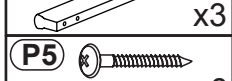
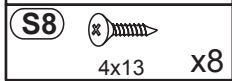
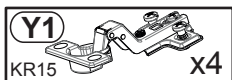
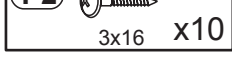
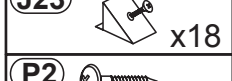
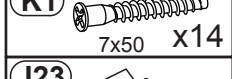
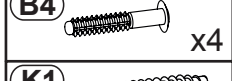
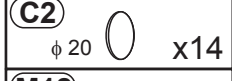
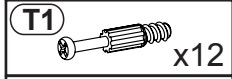
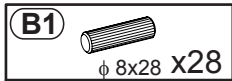

Nr	Ausmaß			St
1	292	383	15	1
2	292	383	15	1
3	342	100	12	1
4	342	100	12	1
5	138	346	15	1
6	292	348	15	1
7	292	348	15	1
8	986	347	15	1
9	954	100	12	1
10	2000	384	15	1
11	2000	384	15	1
12	998	158	16	1
13	496	320	16	2
14	1982	306	2	1
15	965	341	2	1

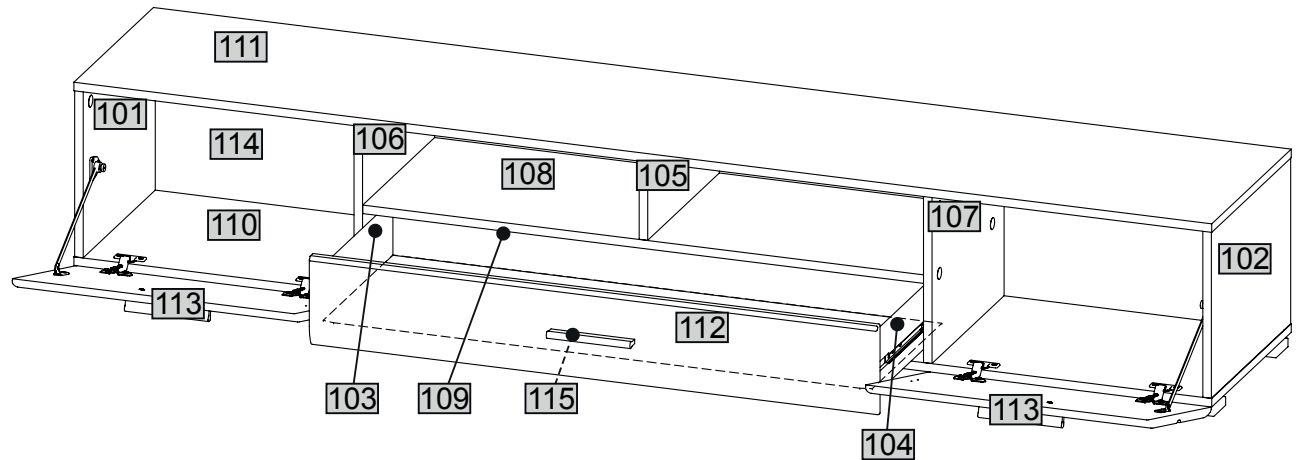

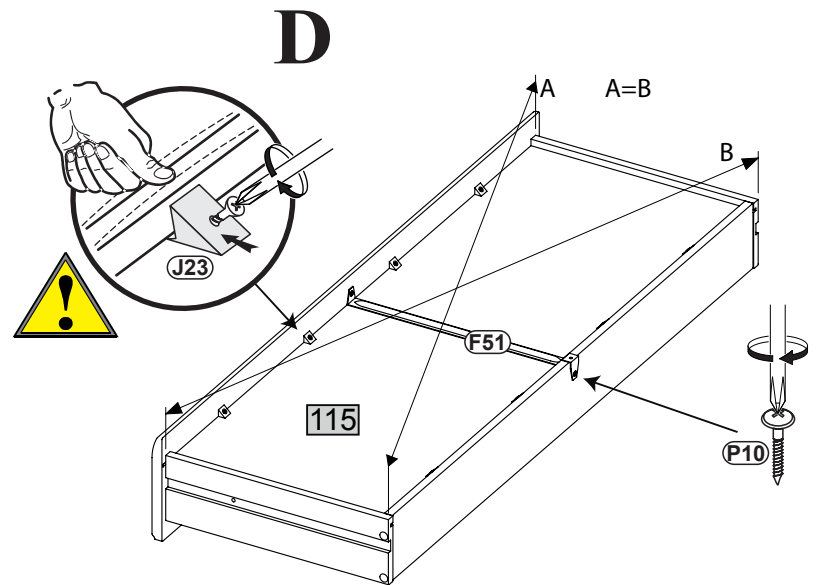
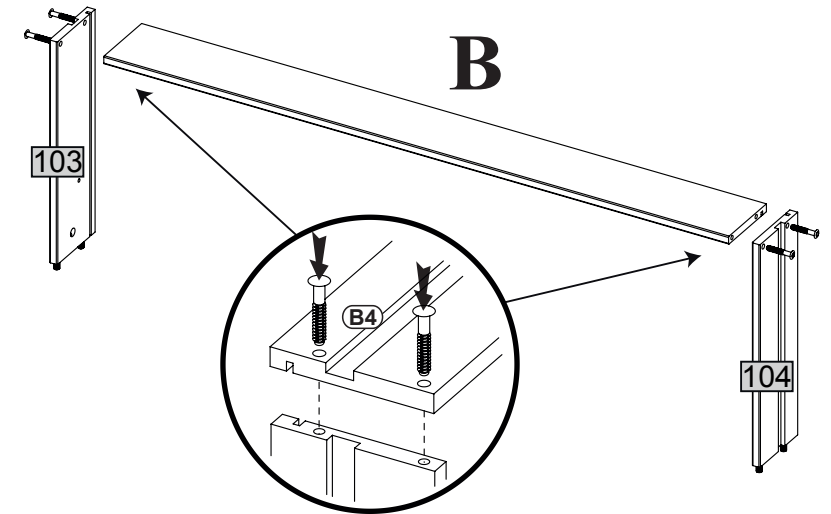
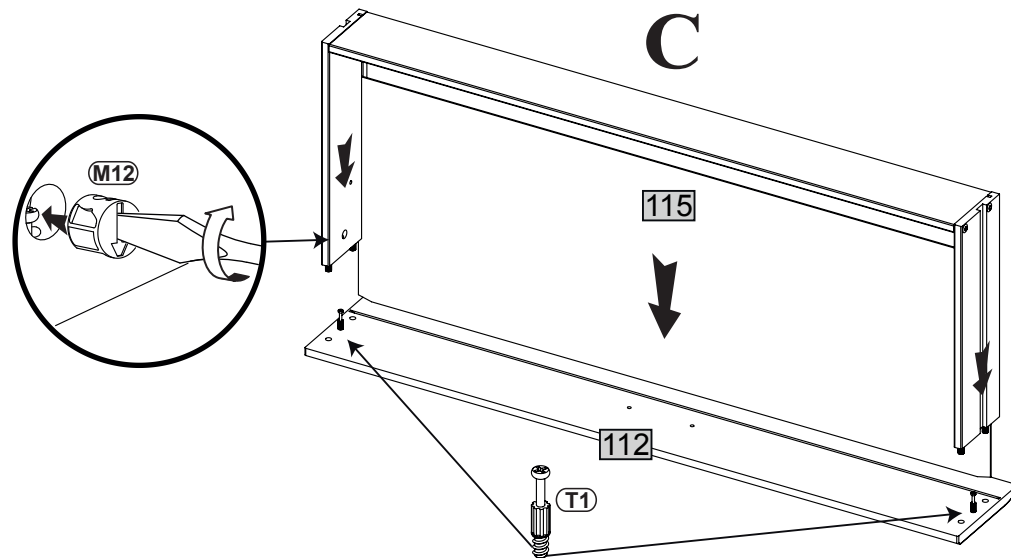
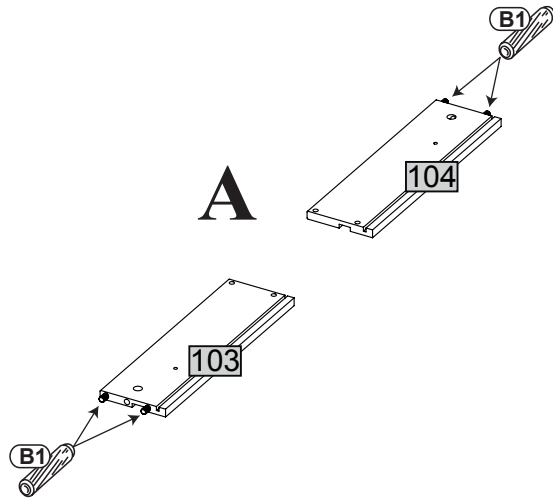
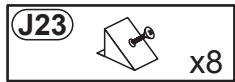
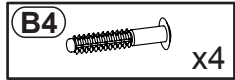
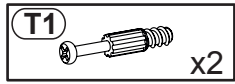
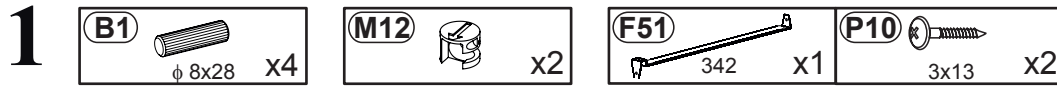

2

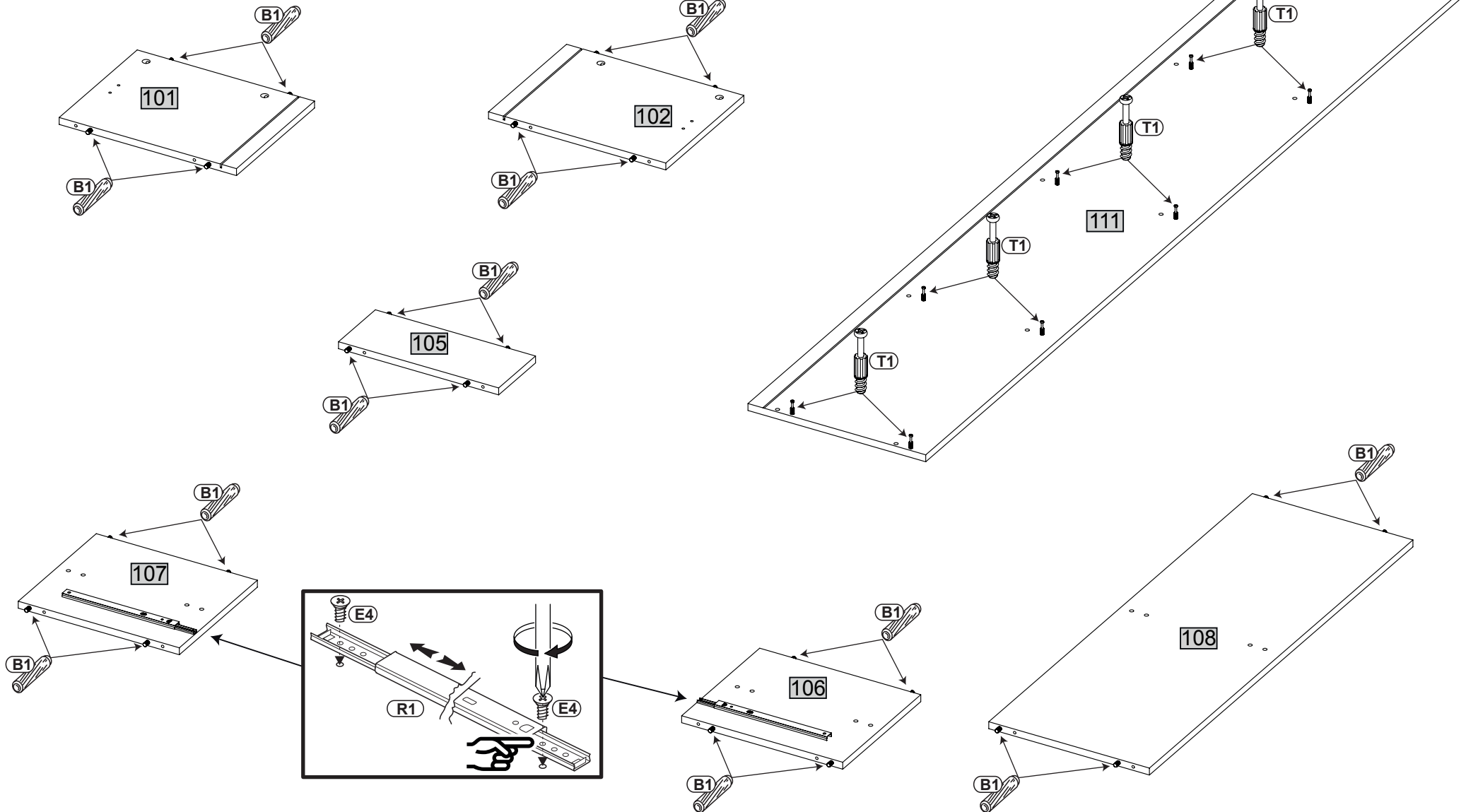
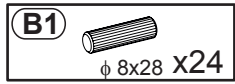
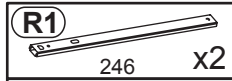
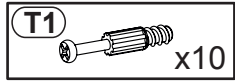

3

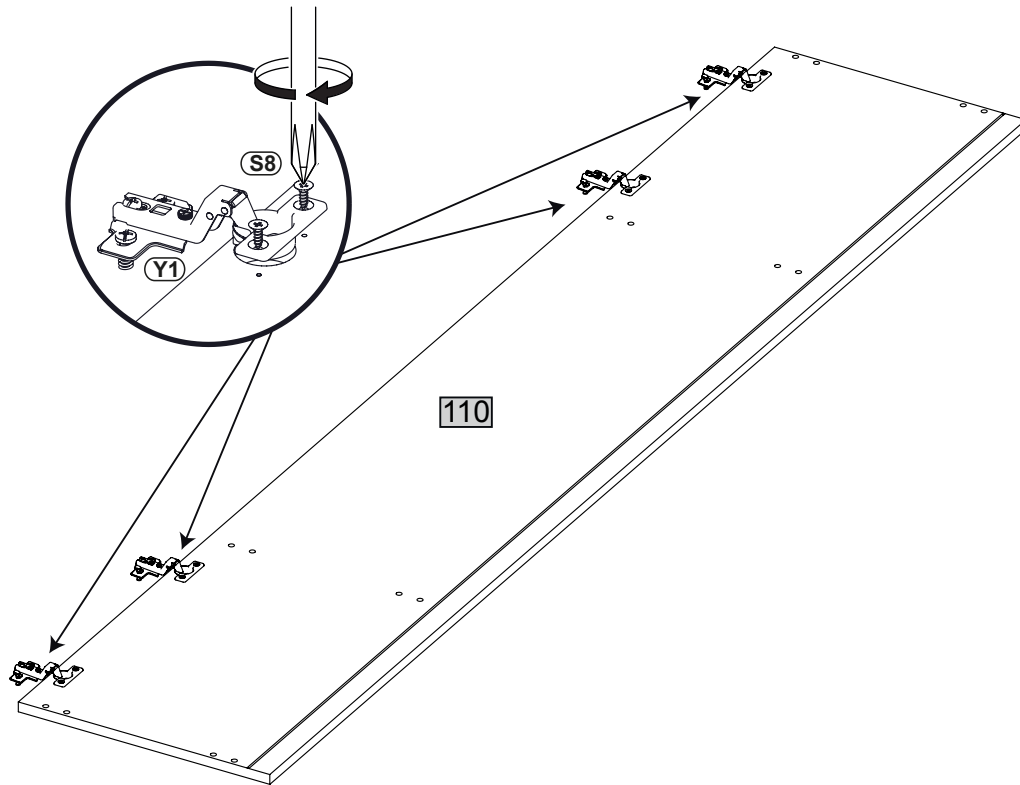
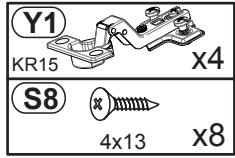

4

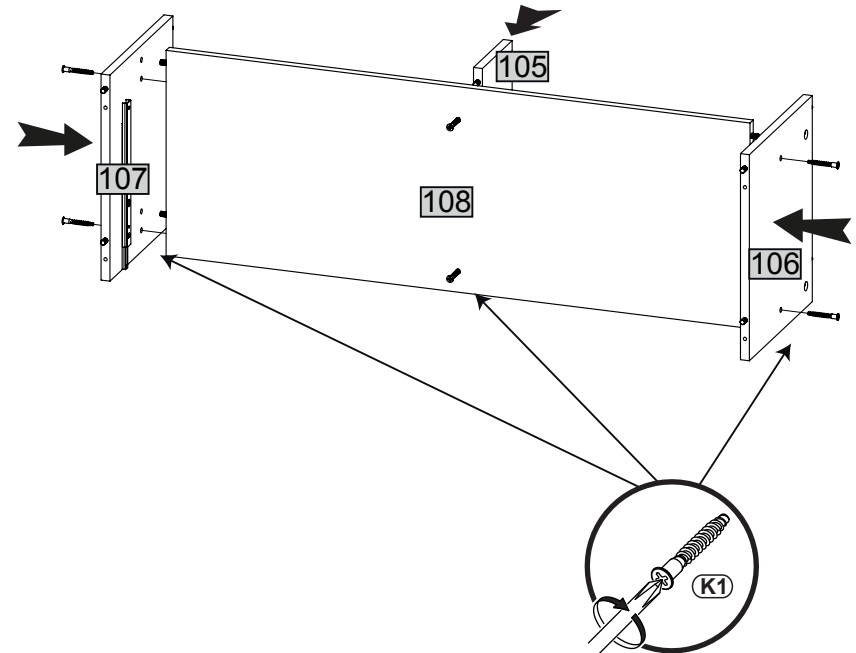
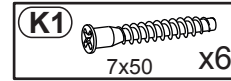

5

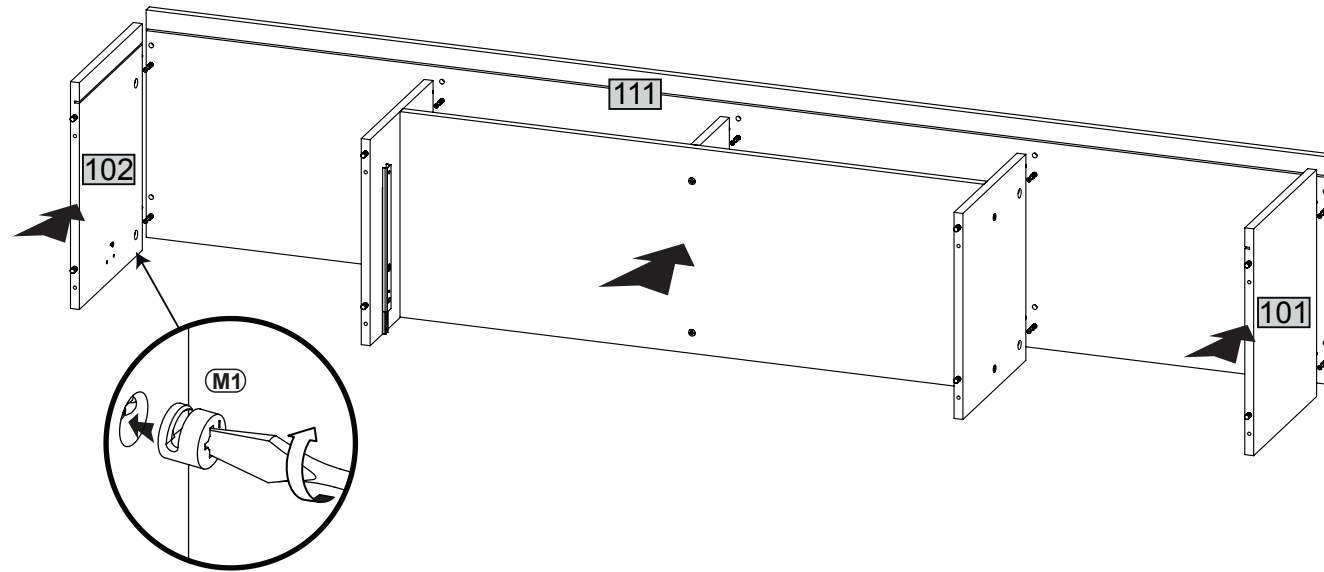

6

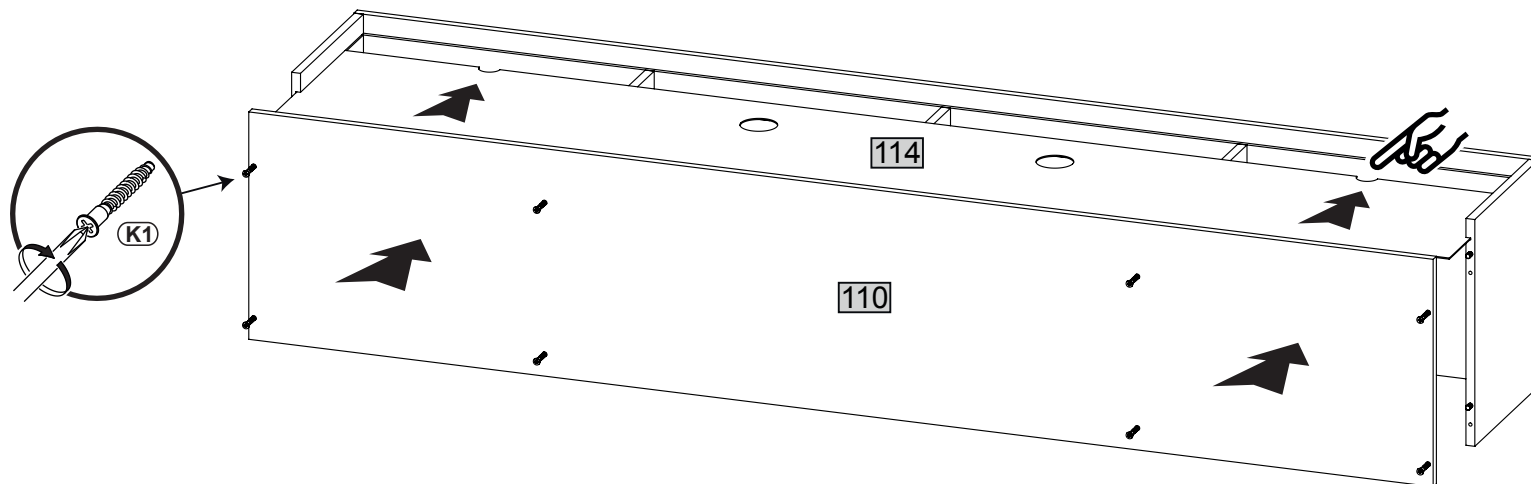
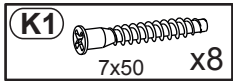



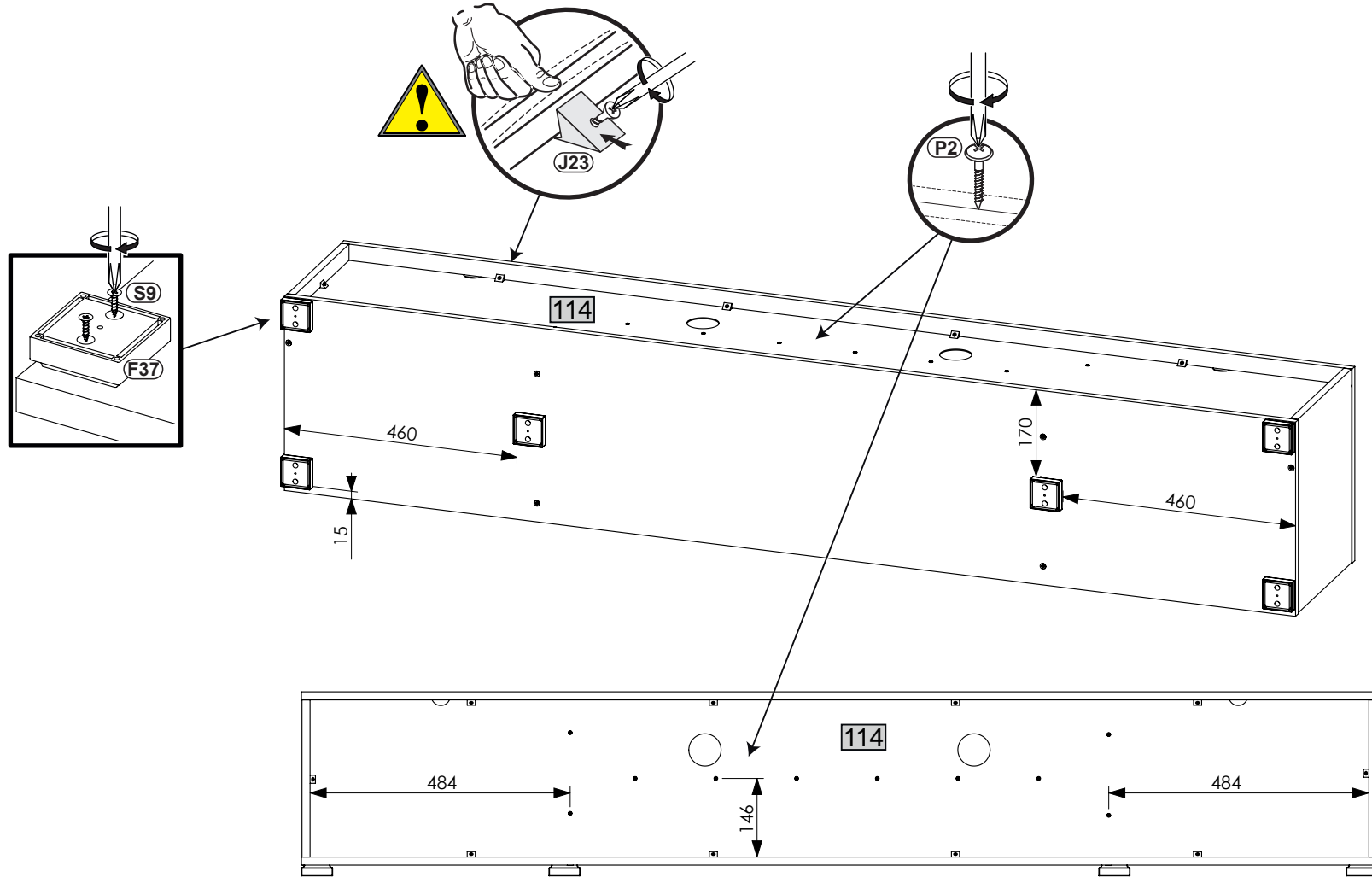
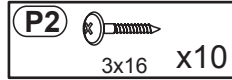
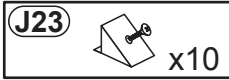
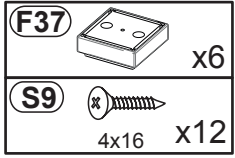

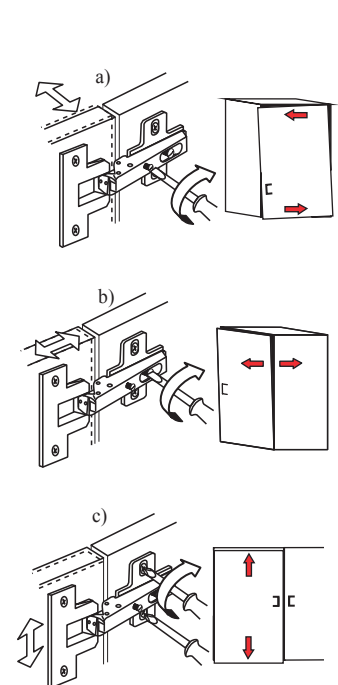
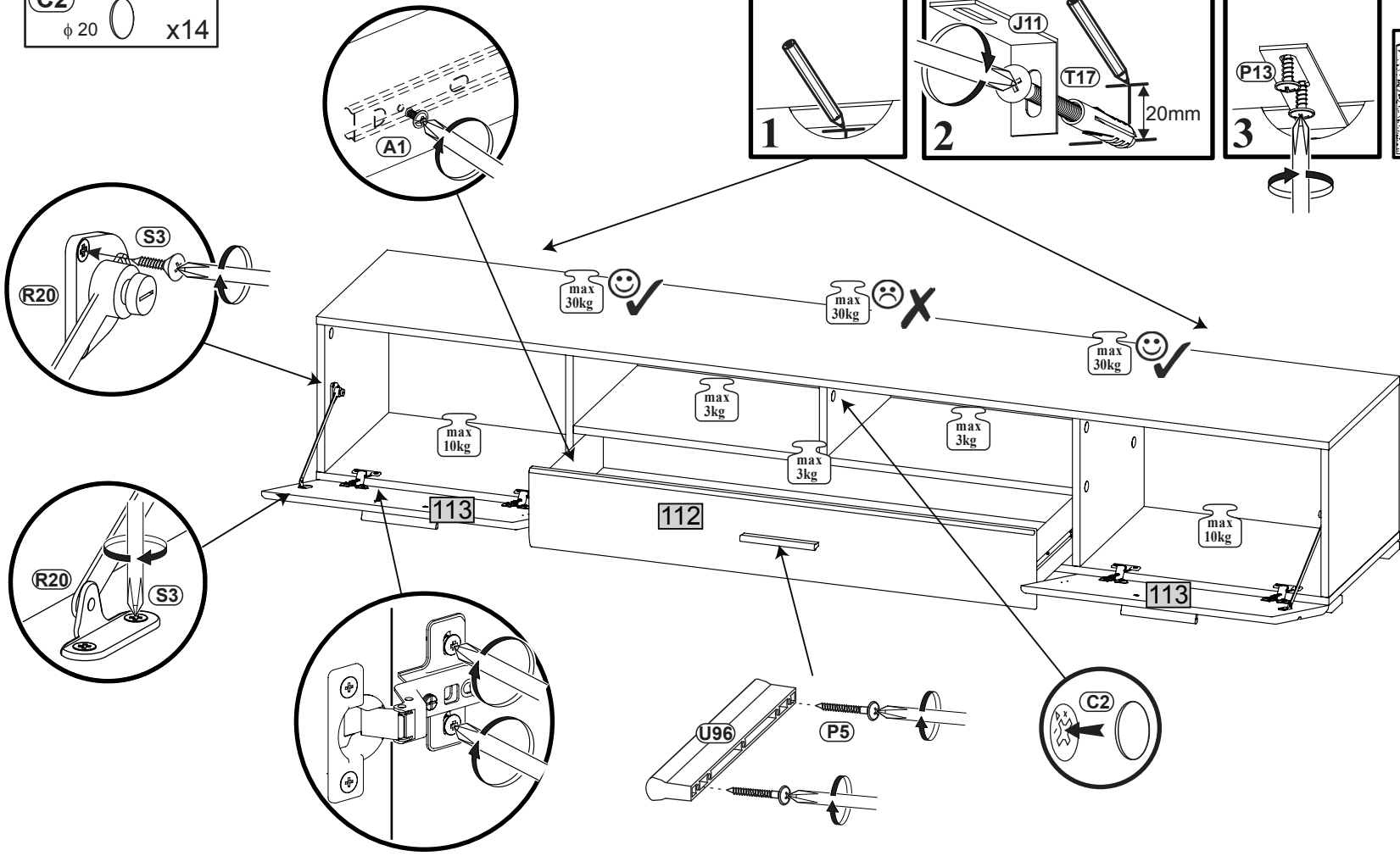
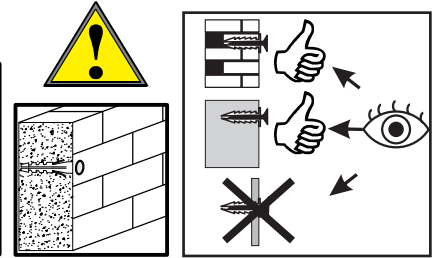
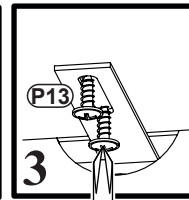
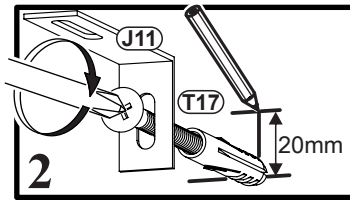
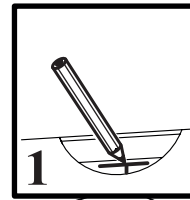
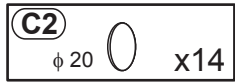
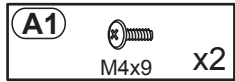
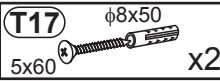
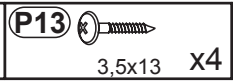
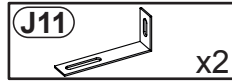
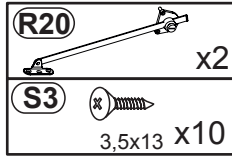
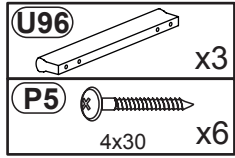

7

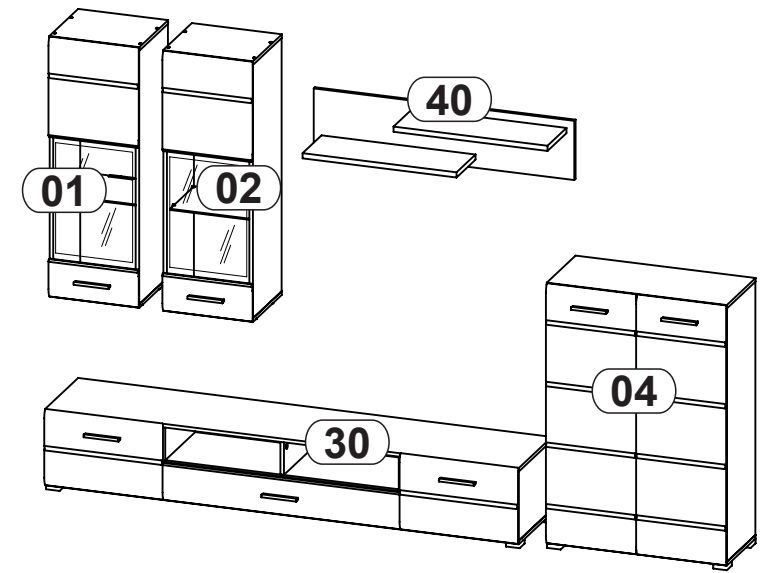
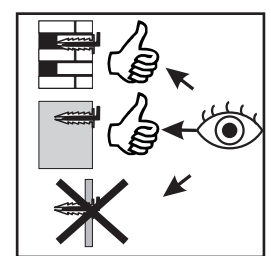
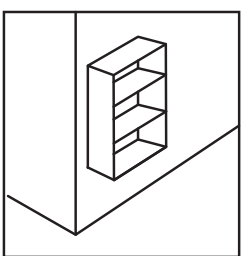
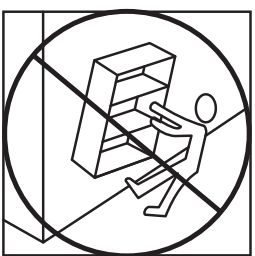
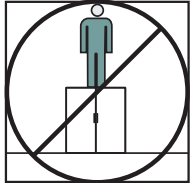
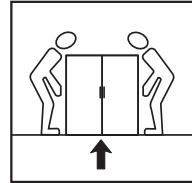
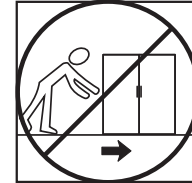
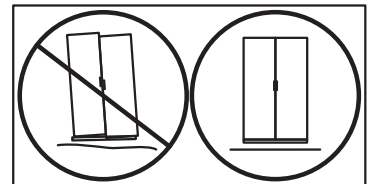
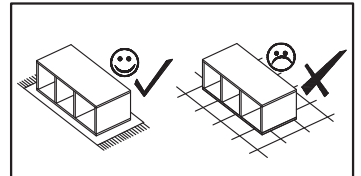
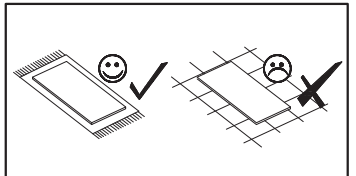
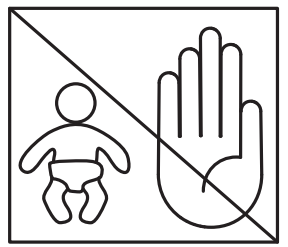
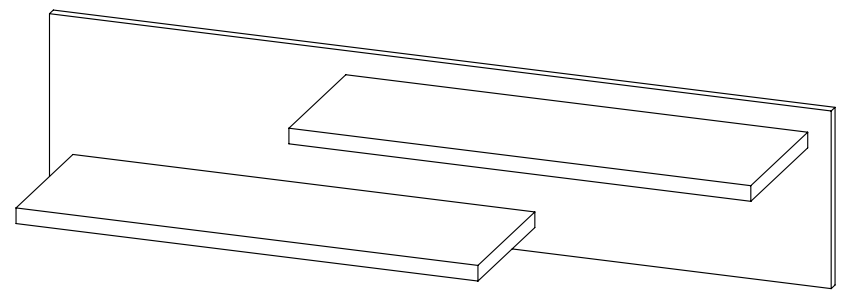
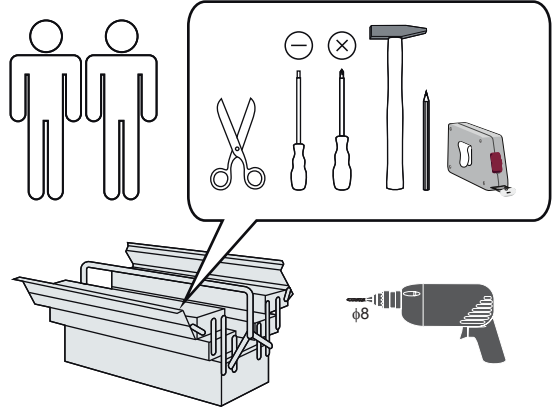

8





F50		x2
E4		x4
	6x8	
T10		x2
	φ8x50	
	φ4,5x60	
K2		x6
	7x70	
L6		x2

Nr	Ausmaß			St
101	1100	250	15	1
102	650	220	22	2

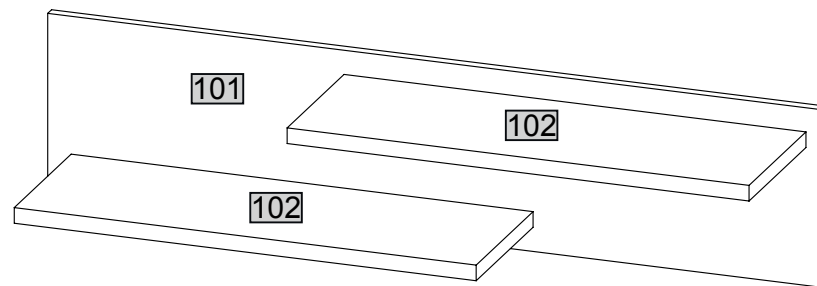

1

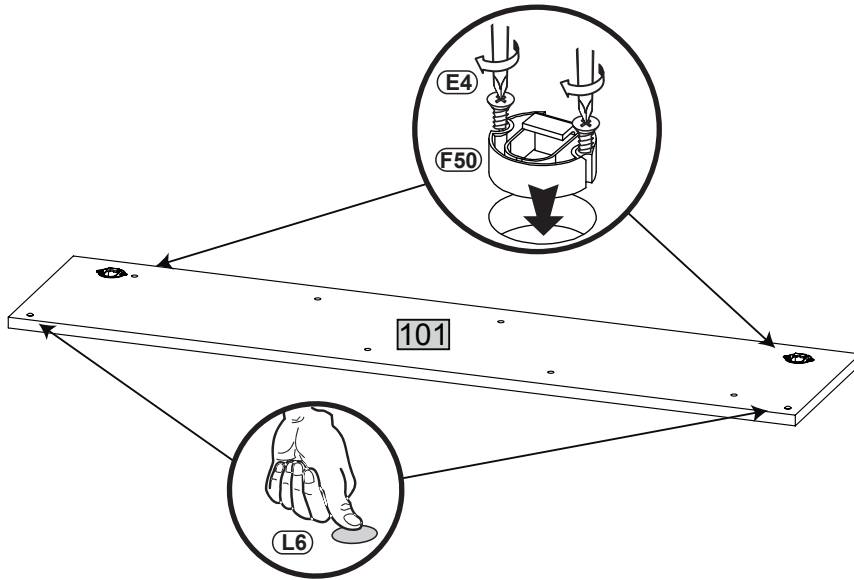
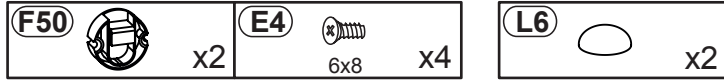

2

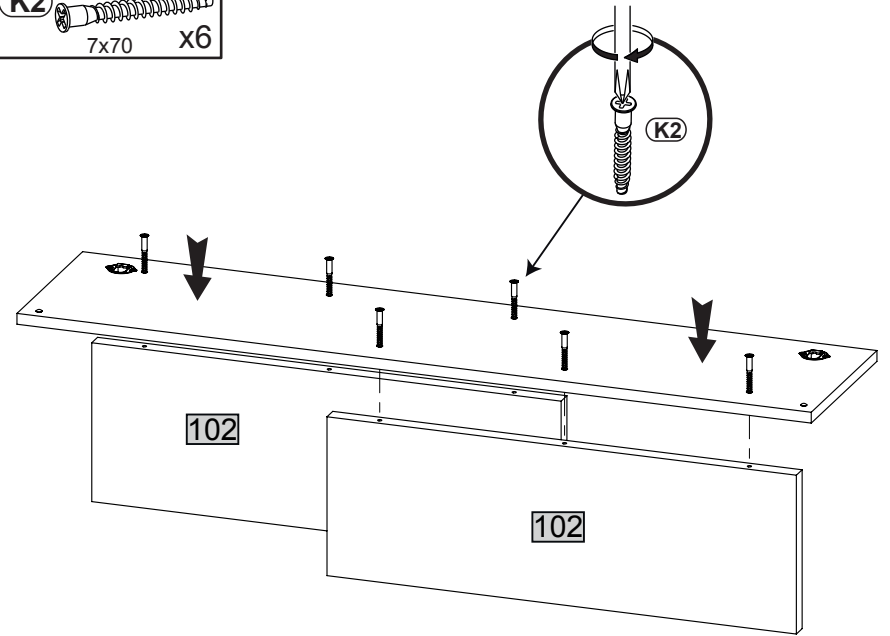
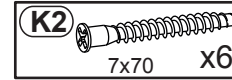

3

