

Aurora

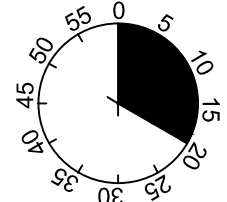

1

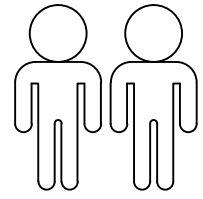
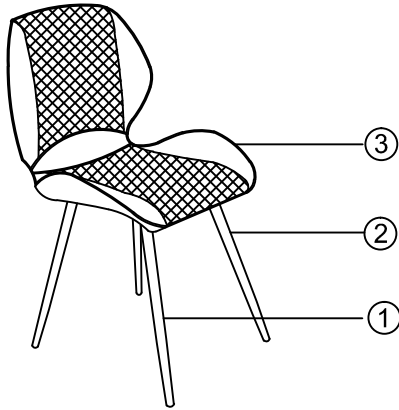
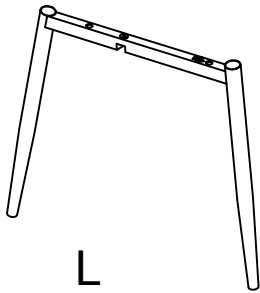

L

2

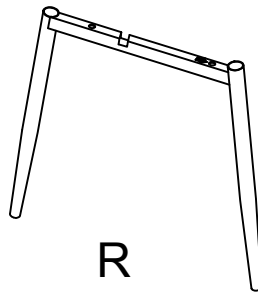

R

3

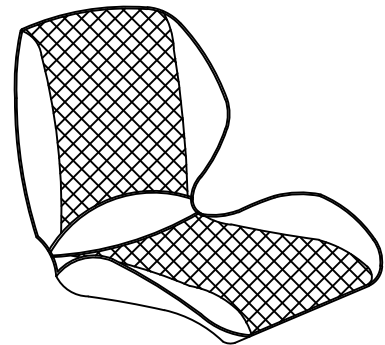

1	1x	2/2
2	1x	2/2
3	1x	1/2

A

M6X40



4x

B

M6X25



1x

C

Ø18xØ6x1.5



5x

D

4MM





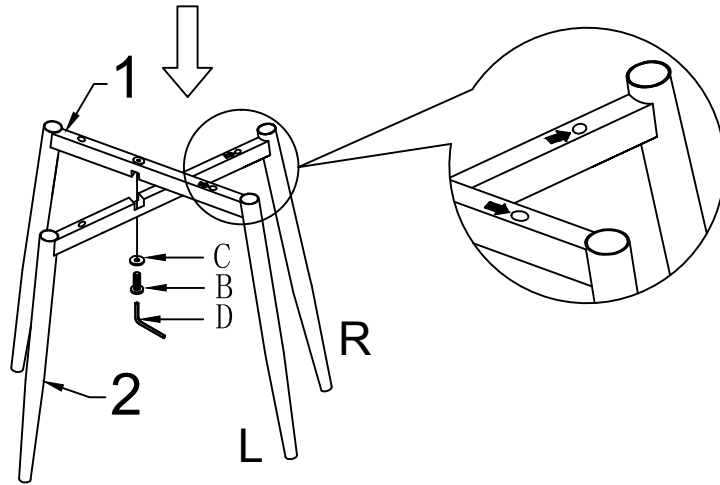

1x

I.



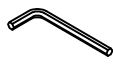

1

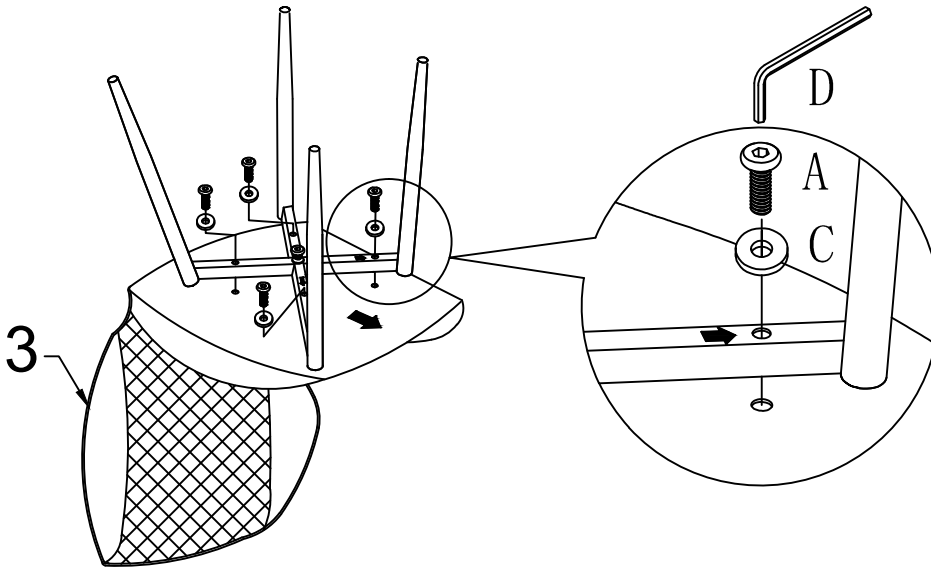

- B** M6x25
 1x
- C** Ø18xØ6x1.5
 1x
- D** 4MM
 1x
- 

2



- A** M6X40
 4x
- C** Ø18xØ6x1.5
 4x
- D** 4MM
 1x
- 

3

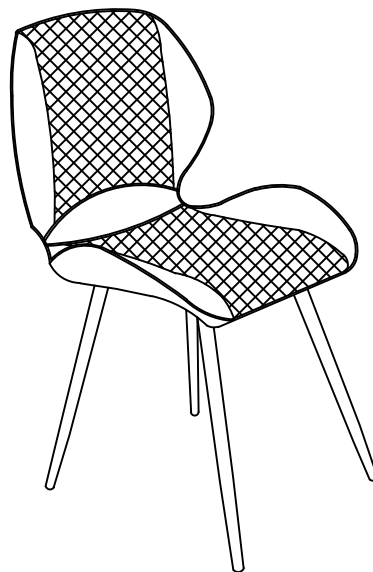

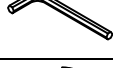
- D** 4MM
 1x
- 