

1. predsieň TINA 2

Montážny návod







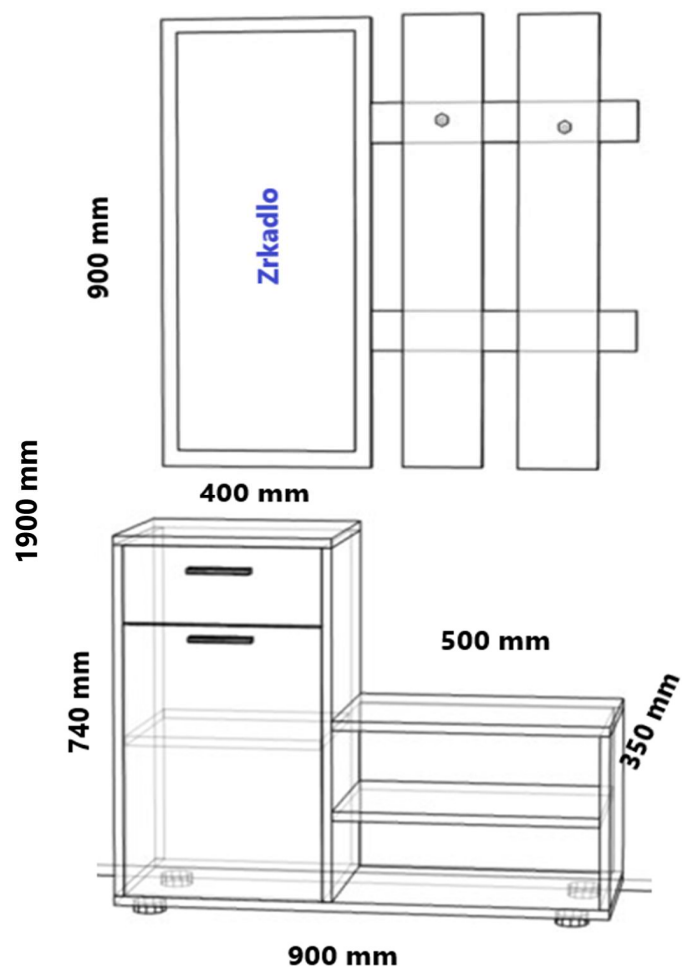







Montážní návod

Die Montage Anleitung

Assembly Instruction



2.

I		5 x	Q		(3,5 x 16mm) 30 x
Z		1 x	R		(3,5 x 30mm) 22 x
M.4		(Vložený) 2 x	U.3		(4 x 50mm) 11 x
	(Vešiak) 2 x	F		40 x	
	(Uchytka) 2 x	H		8 x	
	(300 mm) 1 pár	A		42 x	
	2x	J		2x	

3.

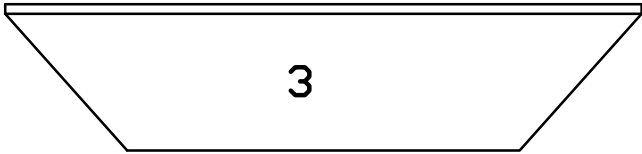

Najskôr zmontuj 2-1 + 3-1 + 2 + 5-1
Nejdřív smontuj 2-1 + 3-1 + 2 + 5-1
First together 2-1 + 3-1 + 2 + 5-1
Zuerst zusammen 2-1 + 3-1 + 2 + 5-1

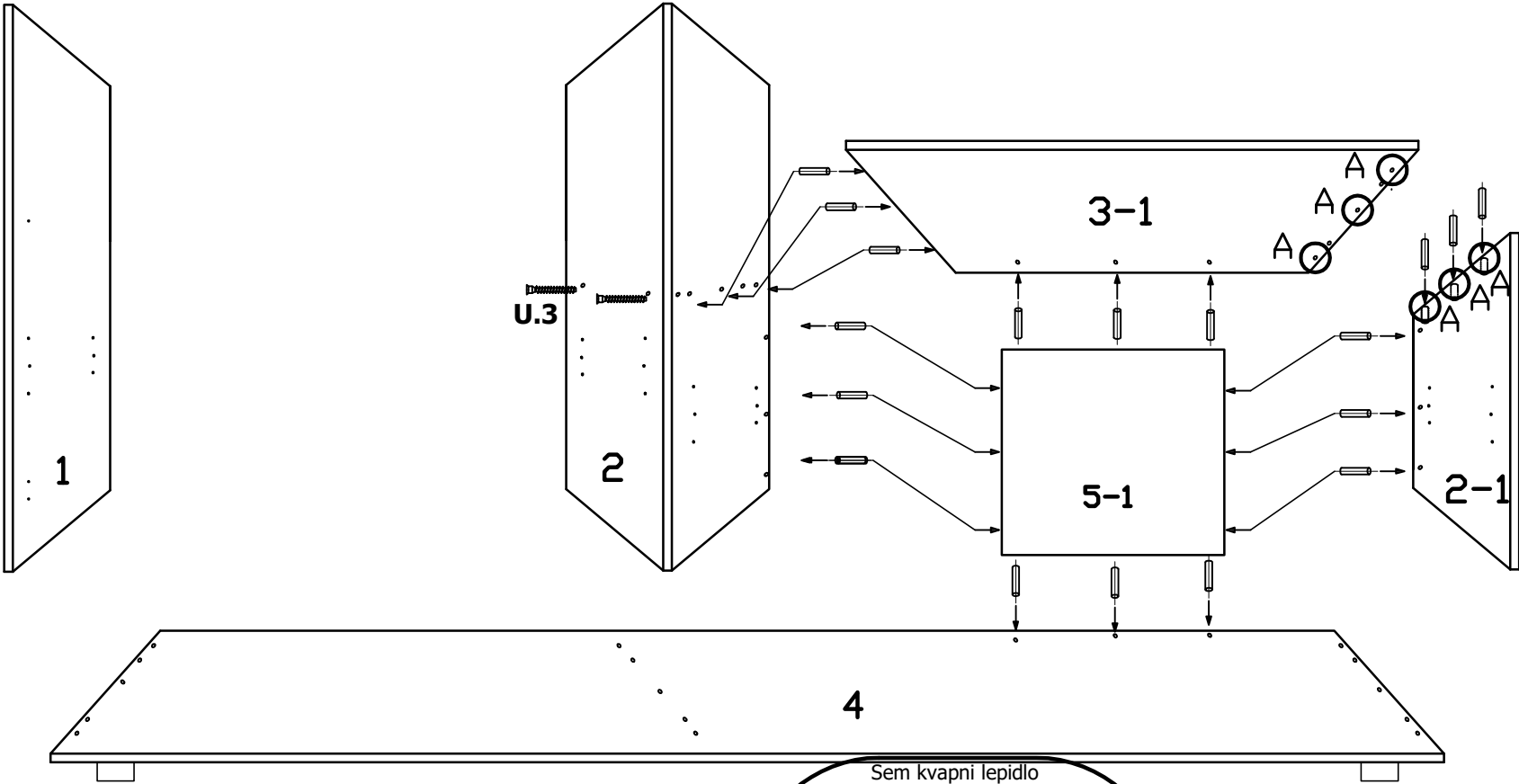

A-Hole for Glue
A-Das Loch fur Kleber
A-Díra pro lepidlo
A-Diera pre lepidlo

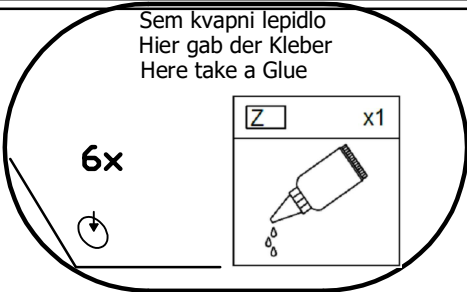

4.

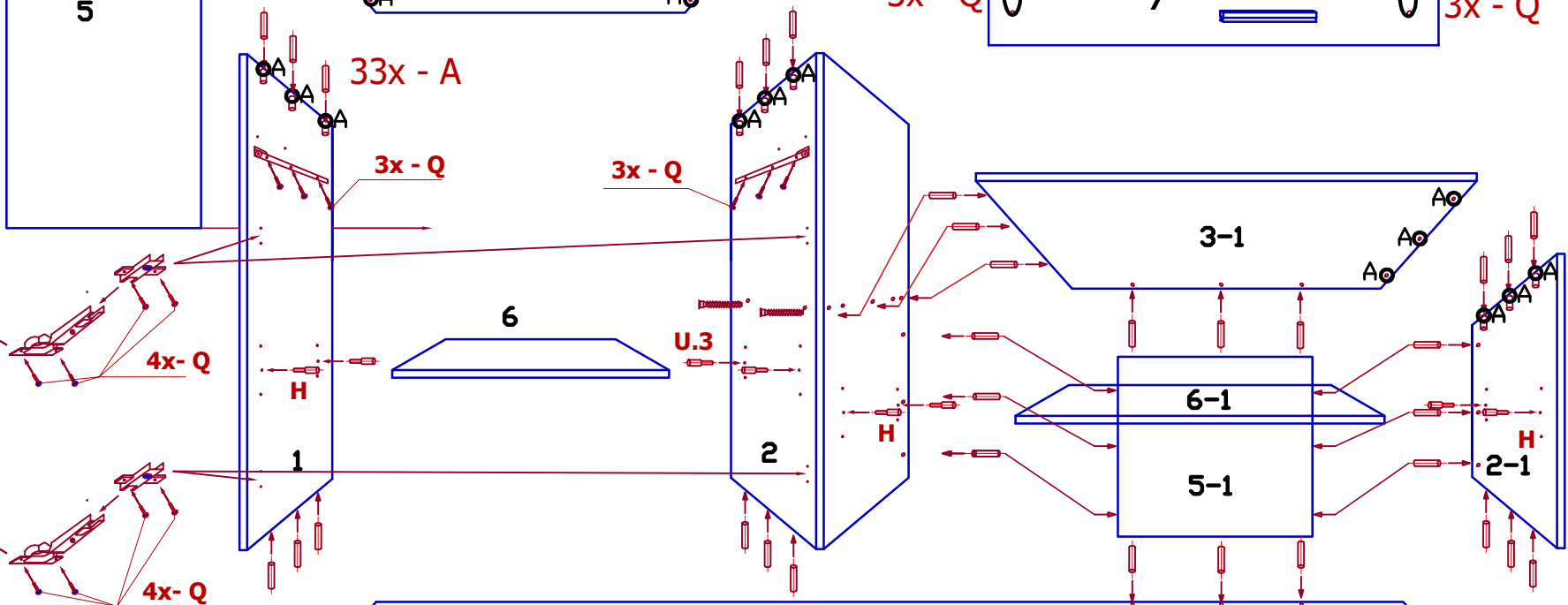
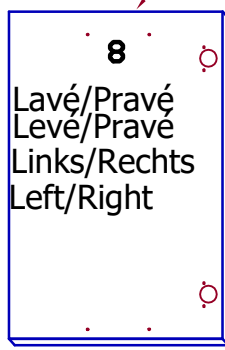
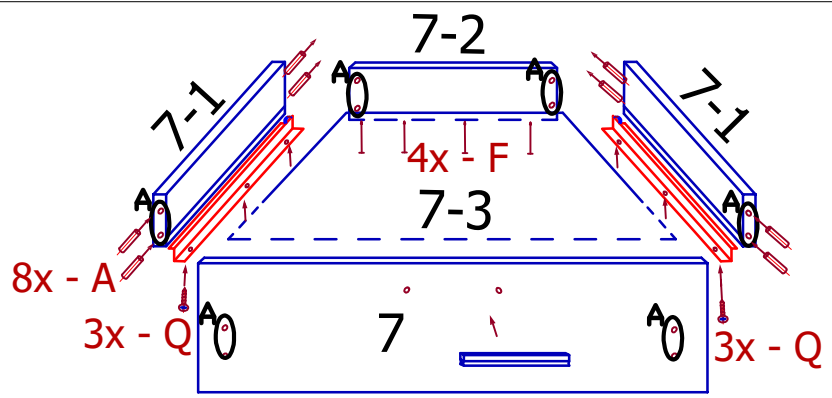
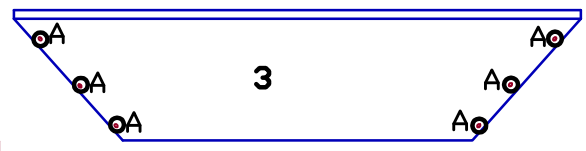
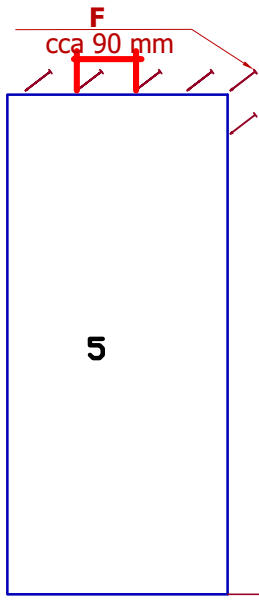

Die Centrum T in Ecke 40 a 40 mm,
 Střed T v rohu 40 a 40 mm,
 Stred T v rohu 40 a 40 mm,

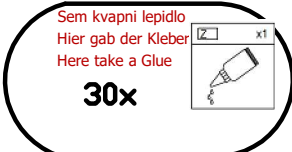
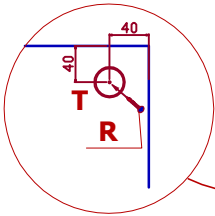

Diera pre lepidlo / Dira pro lepidlo / Das Loch fur Kleber / Hole for Glue

T - cca na sred dna
 T - cca in the center
 T - cca in die Mitte

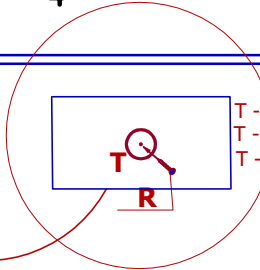

5,

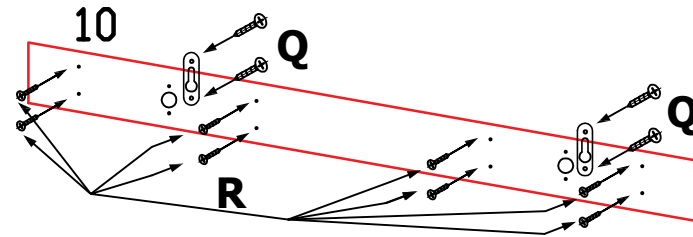

Montuj zo zadnej plochy
Montuj ze zad
Montiert aus Hinterseite
Assemble from Backside

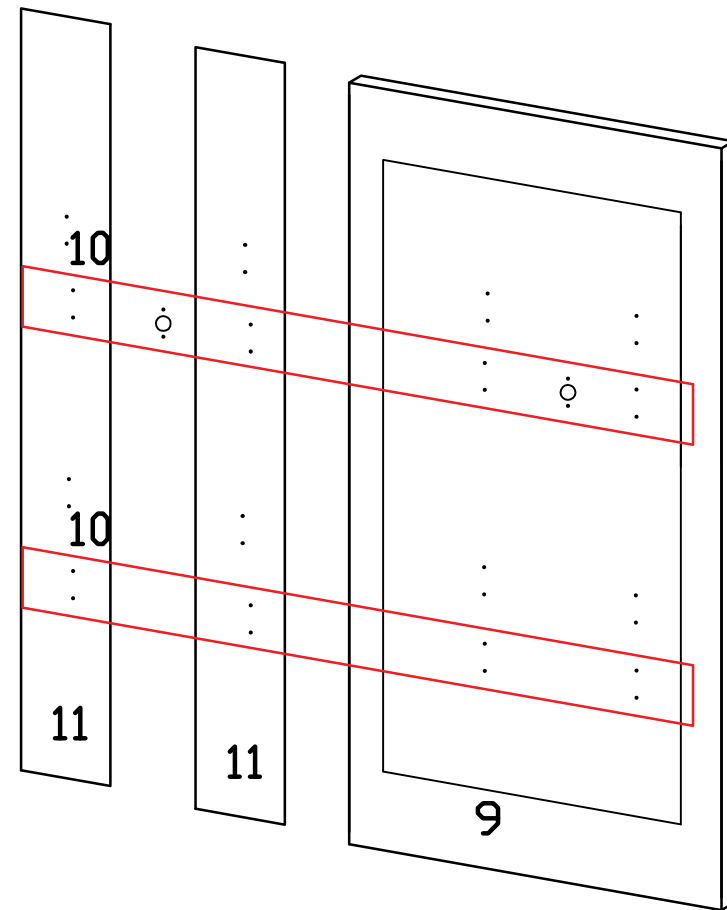

6,

Pohlad - predok

Pohled - předeek

Look - frontside

Sehnen - Der Vorher

