

H100-D

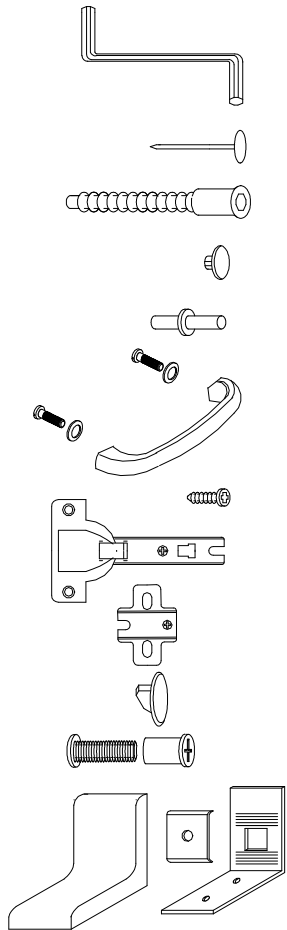
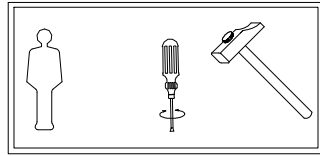
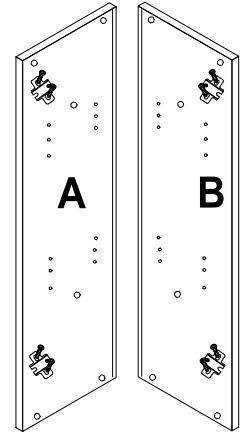
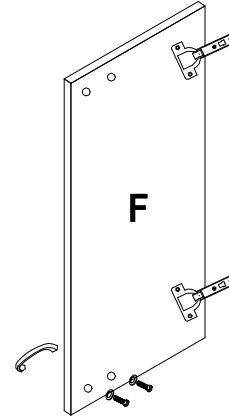
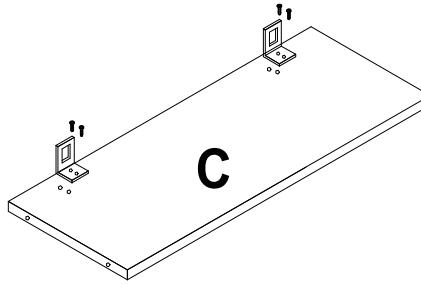
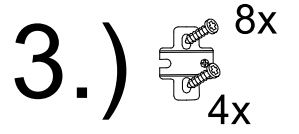
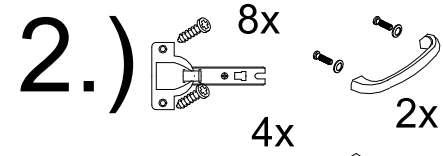
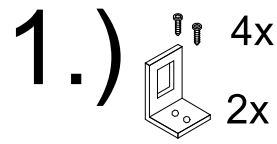
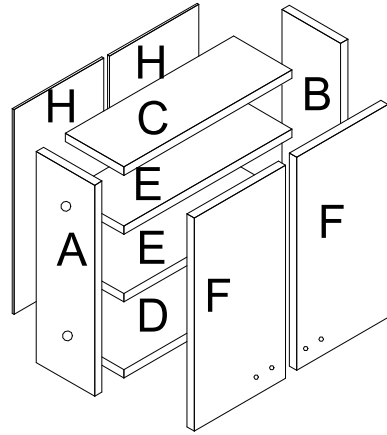
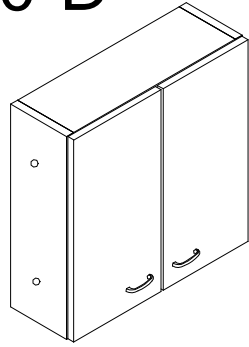

1x
30x

8x

8x

8x

2x

20x

4x

4x

8x

2x

2x

4.)

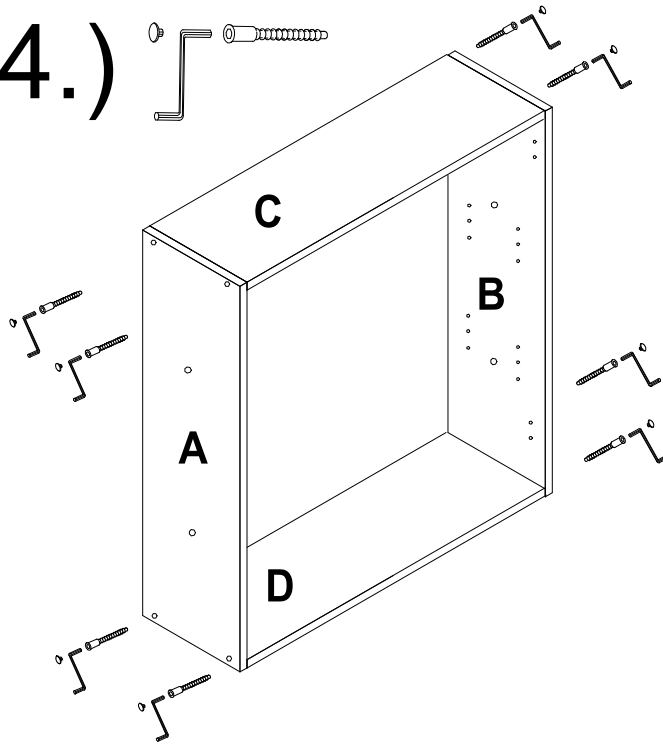
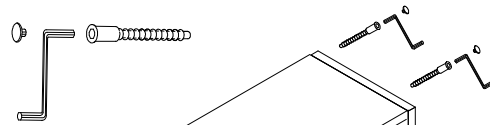

5.)

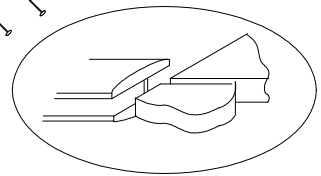
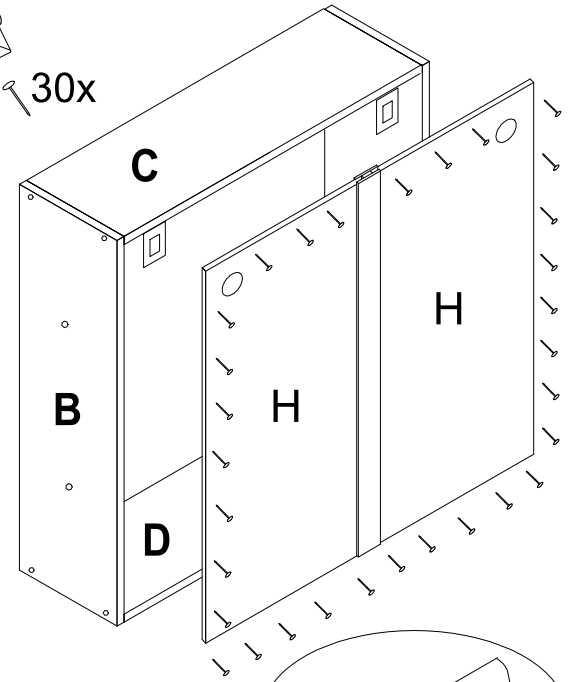
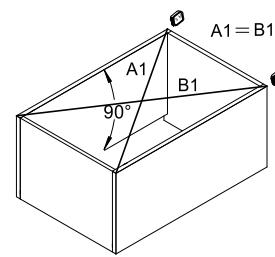
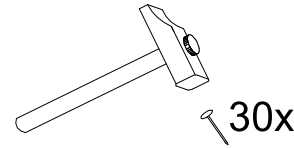

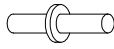
6.)  8x

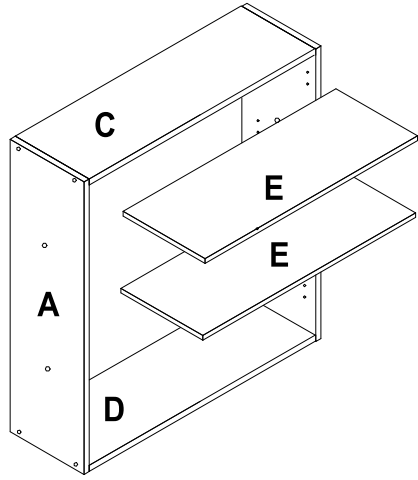

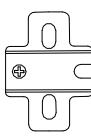
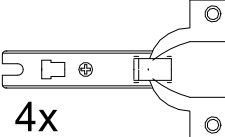
8.)   4x

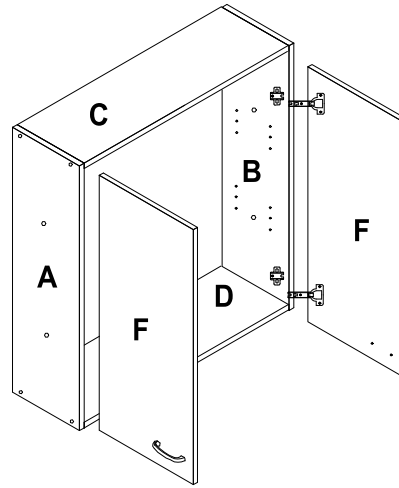

7.)

