

EIKE xxx273

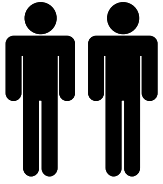

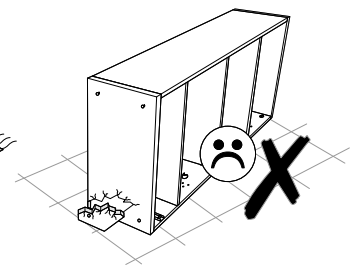

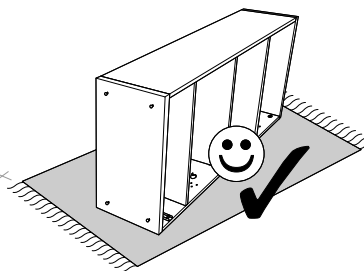

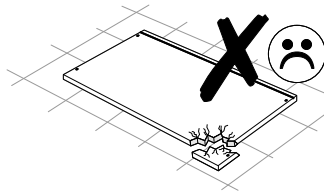
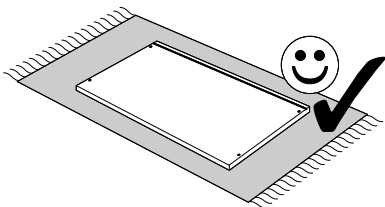
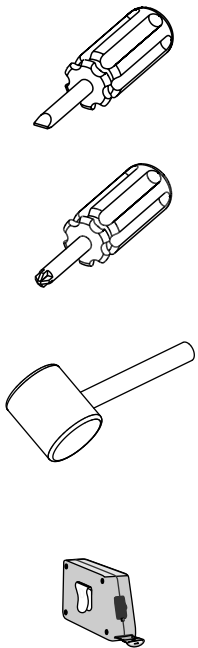
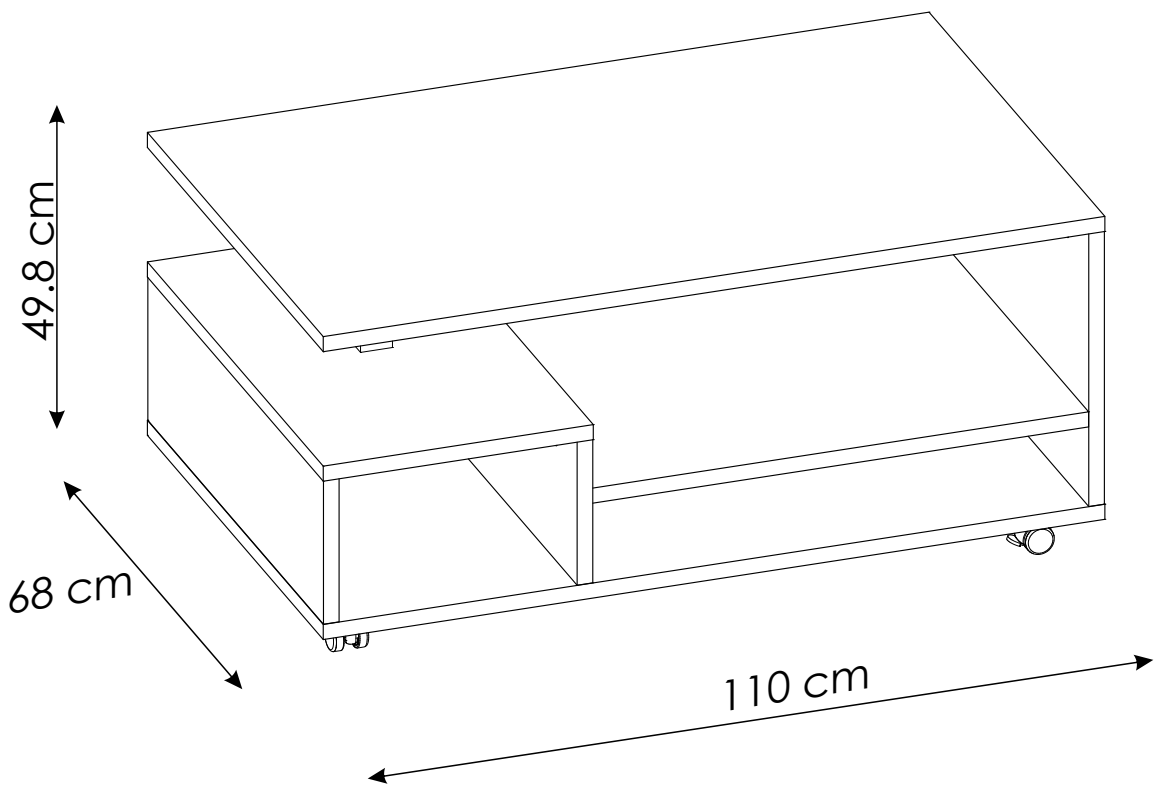
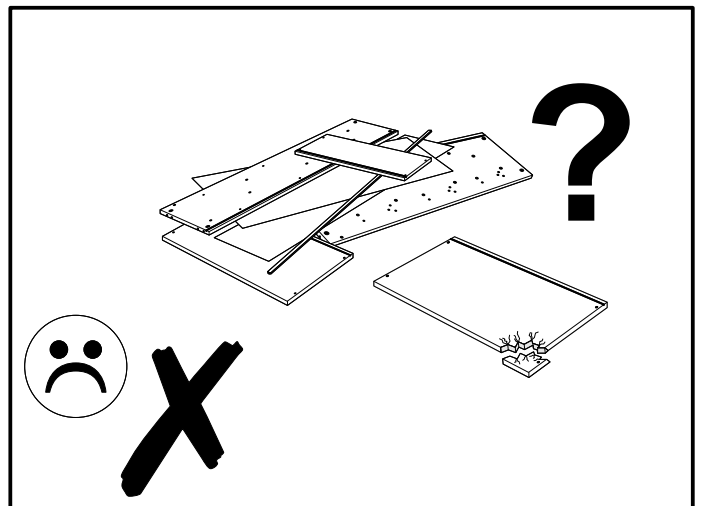
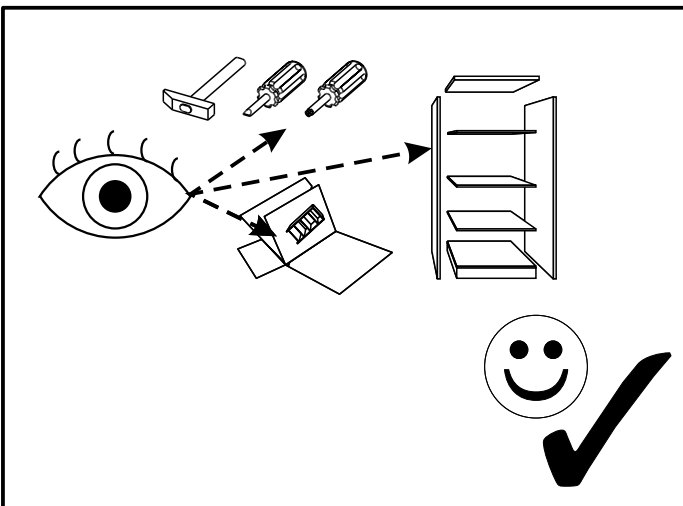
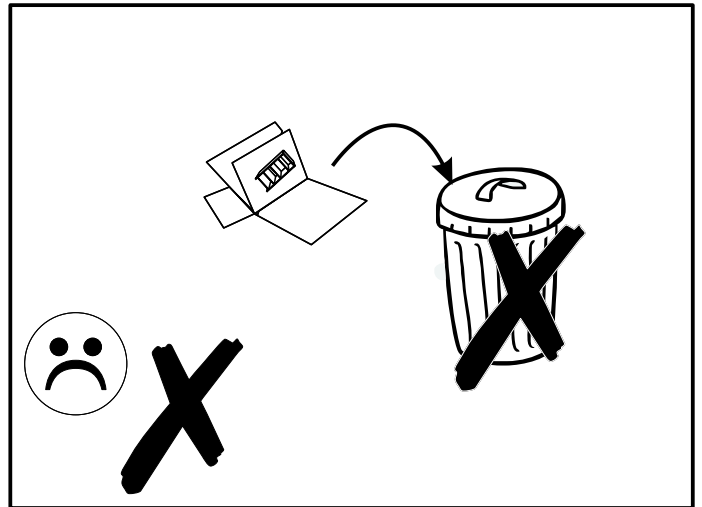
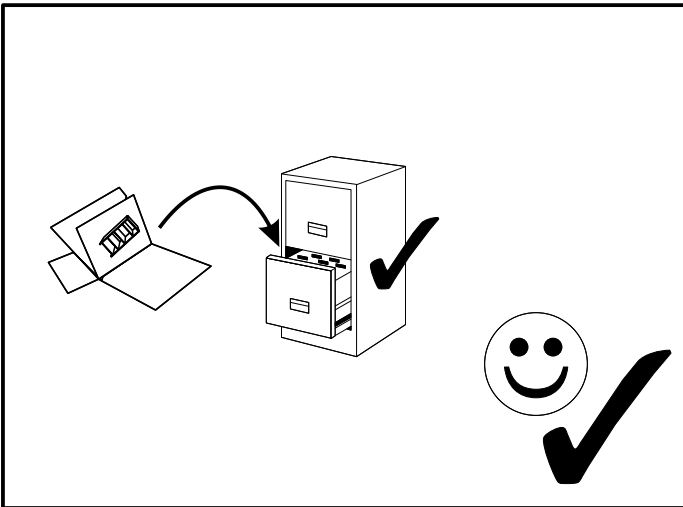
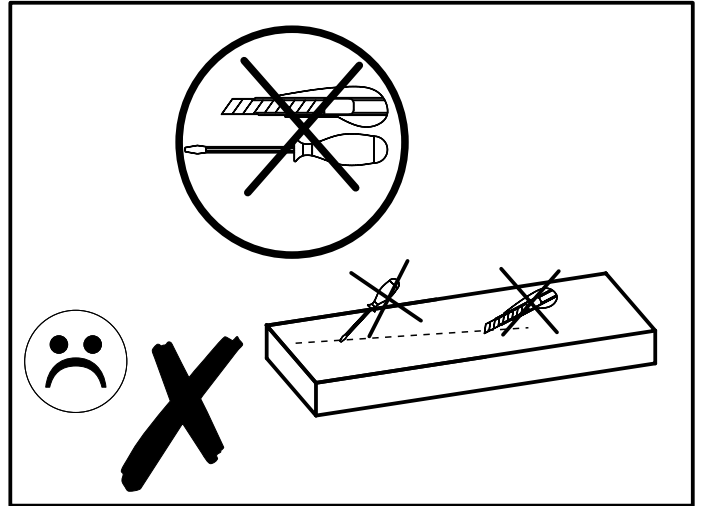
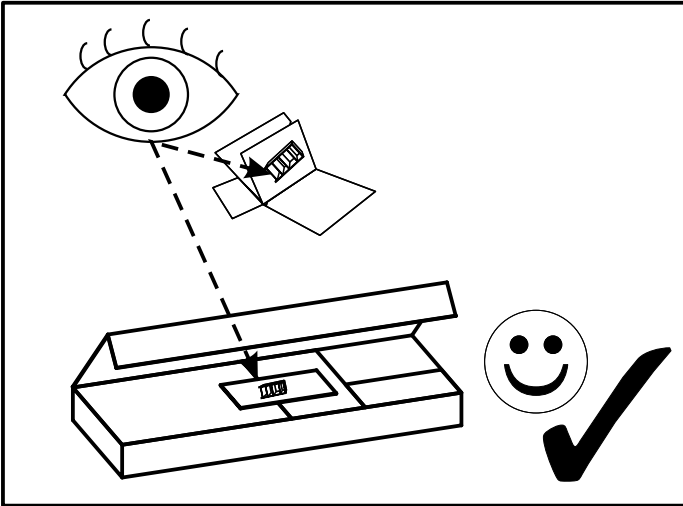
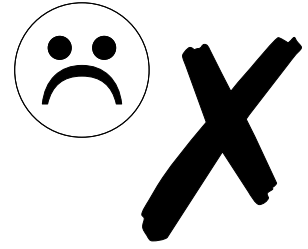



HELA Tische Möbel Vertriebs GmbH
Scheidkamp 14
D - 32584 Löhne



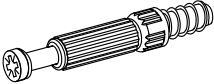

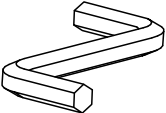
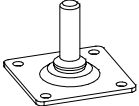
EIKE xxx273

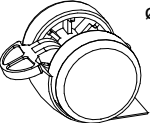
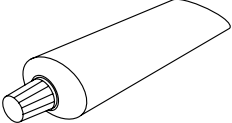
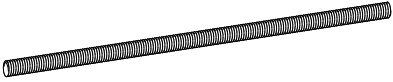
MM

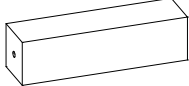
<p>A1 8 x 35 mm x24</p> 	<p>E0 x10</p> 	<p>E1 15 x 12 mm x10</p> 
<p>F1 6 x 34 mm x10</p> 	<p>G2 7 x 60 mm x6</p> 	<p>I2 4 x 16 mm x16</p> 
<p>M x1</p> 	<p>P1 x4</p> 	<p>P ø40x55 mm x2</p> 
<p>PP ø40x55 mm x2</p> 	<p>S x1</p> 	<p>U ø6 x 196 mm x1</p> 
<p>U1 ø15 x 14 (M6x10) mm x1</p> 	<p>U2 ø10 x 12 (M6x10) mm x1</p> 	<p>W 45x45x167 mm x1</p> 

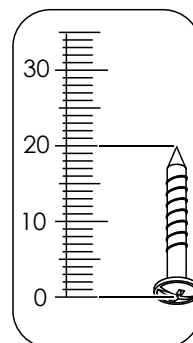
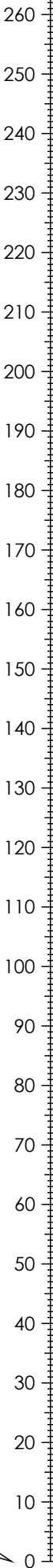

EIKE xxx273

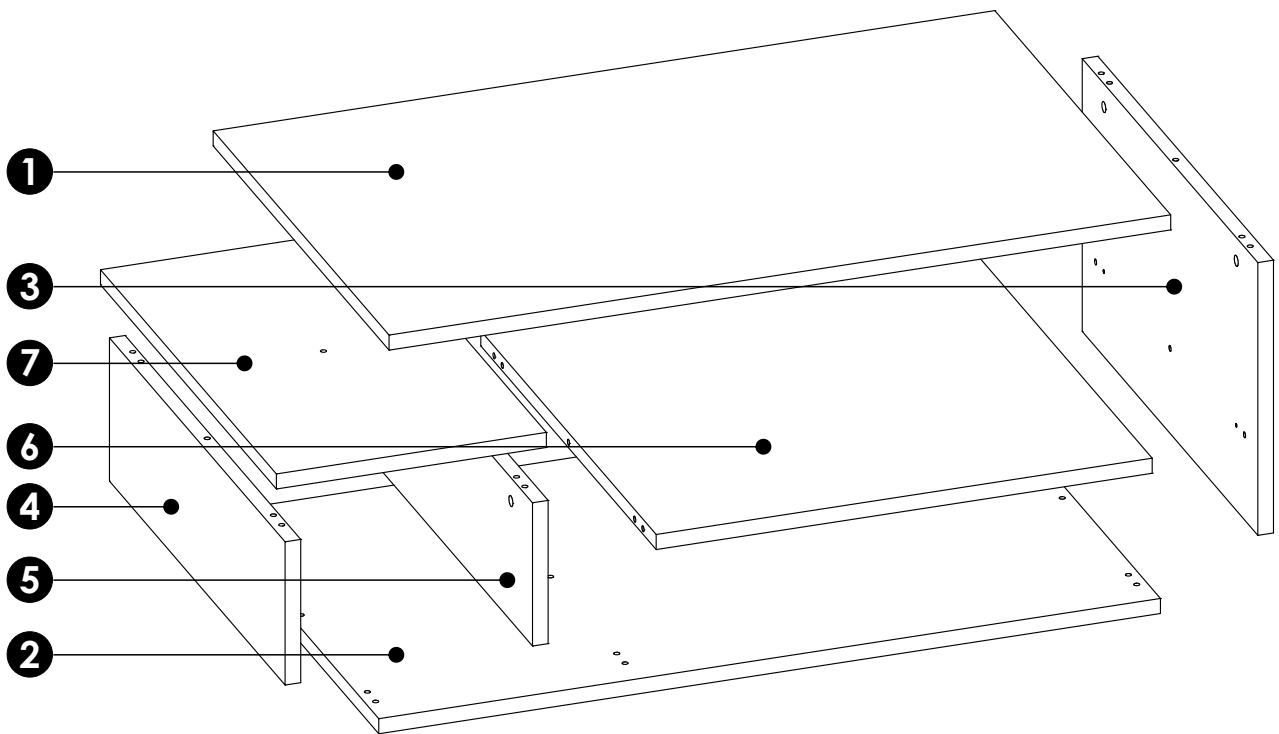
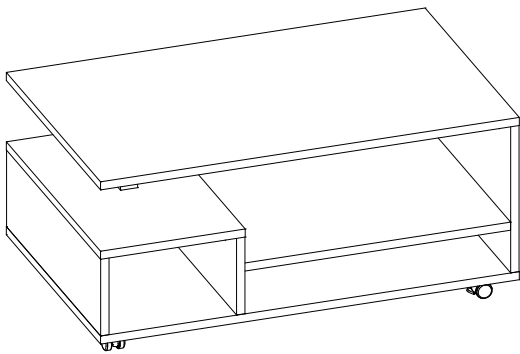
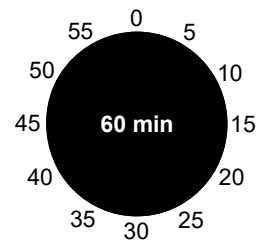

1	1100	680	22	x1	2/2
2	1100	680	22	x1	2/2
3	398	679	22	x1	1/2
4	209	679	22	x1	1/2
5	209	679	22	x1	1/2
6	698	678	22	x1	1/2
7	380	680	22	x1	1/2

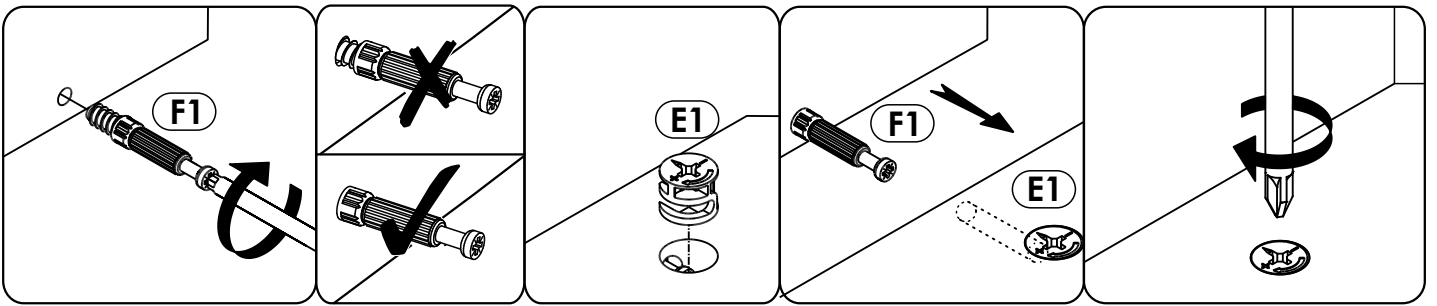

1 ▶

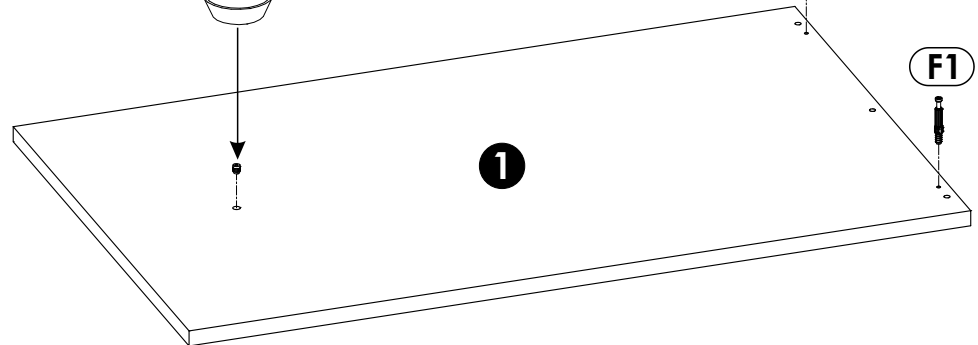
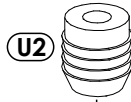
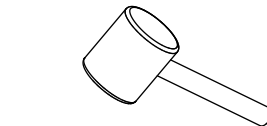
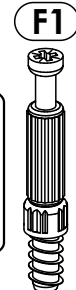
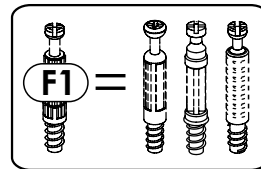
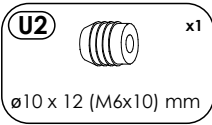
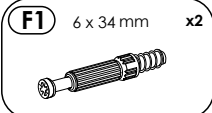
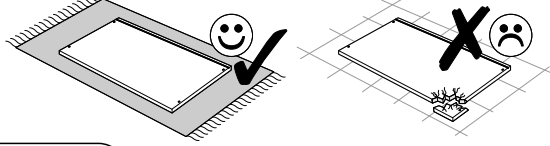

2 ▶

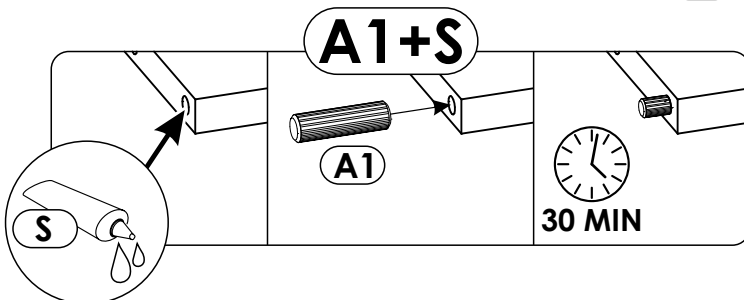
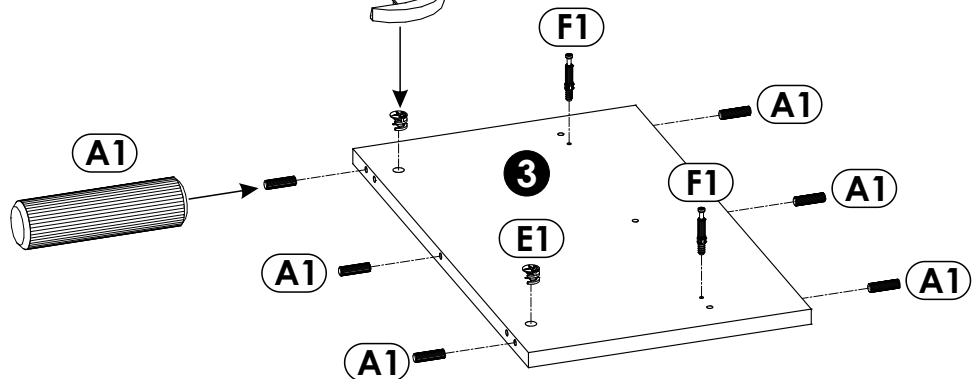
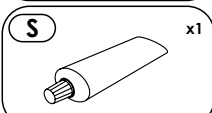
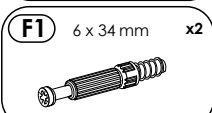
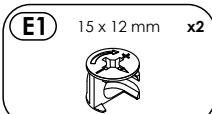
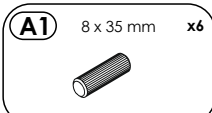
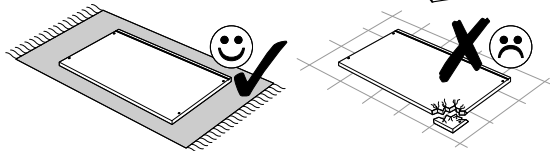

3 ▶

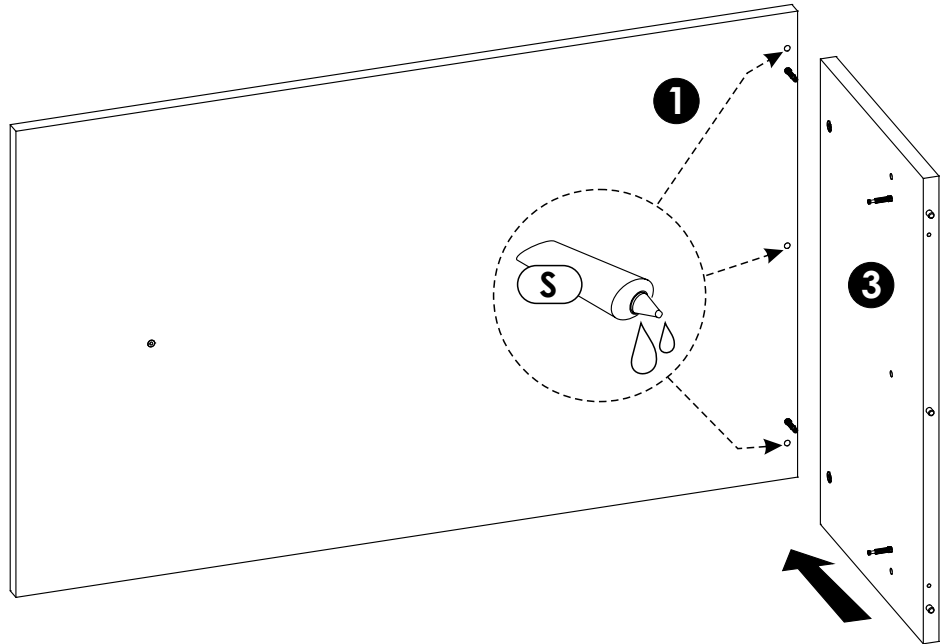
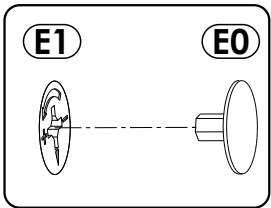
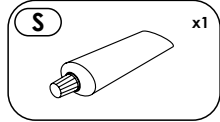
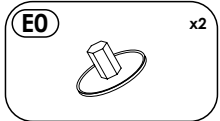
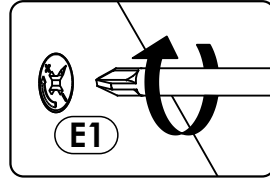
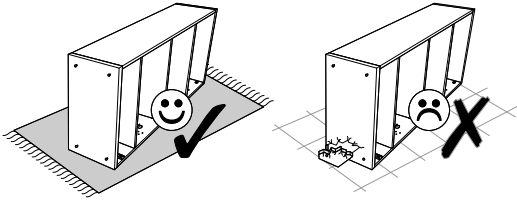

4 ▶

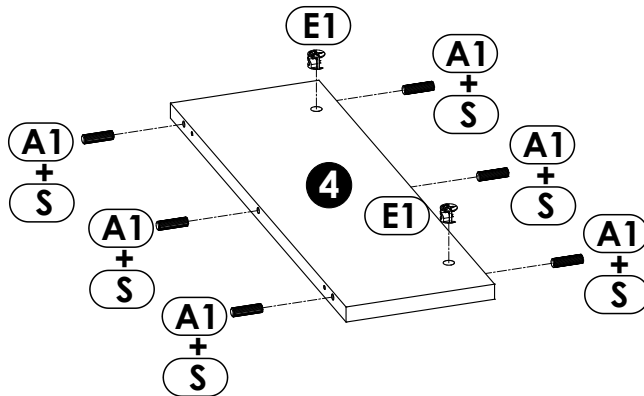
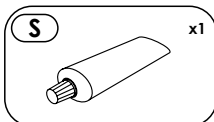
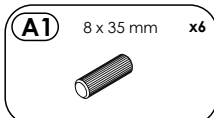
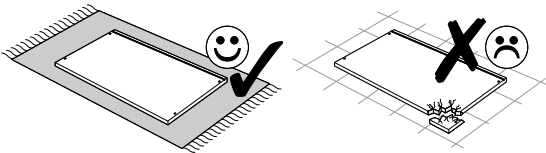

5 ▶

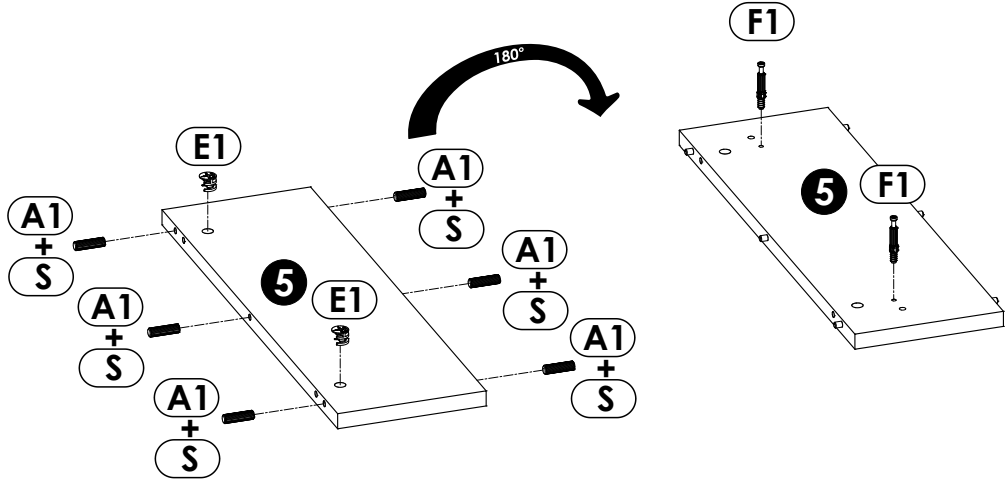
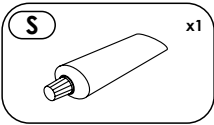
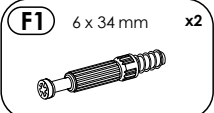
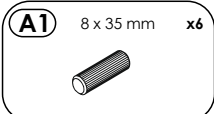
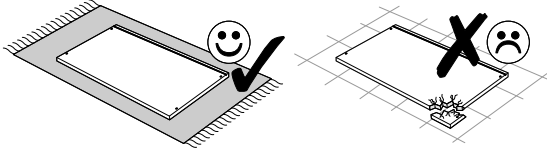

6 ▶

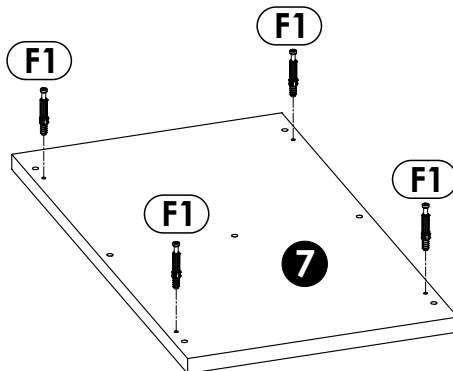
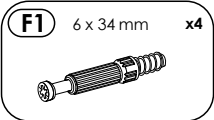
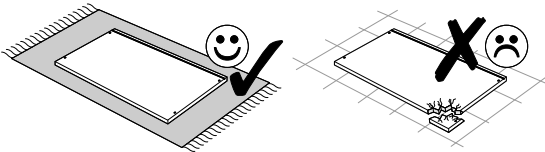

7 ▶

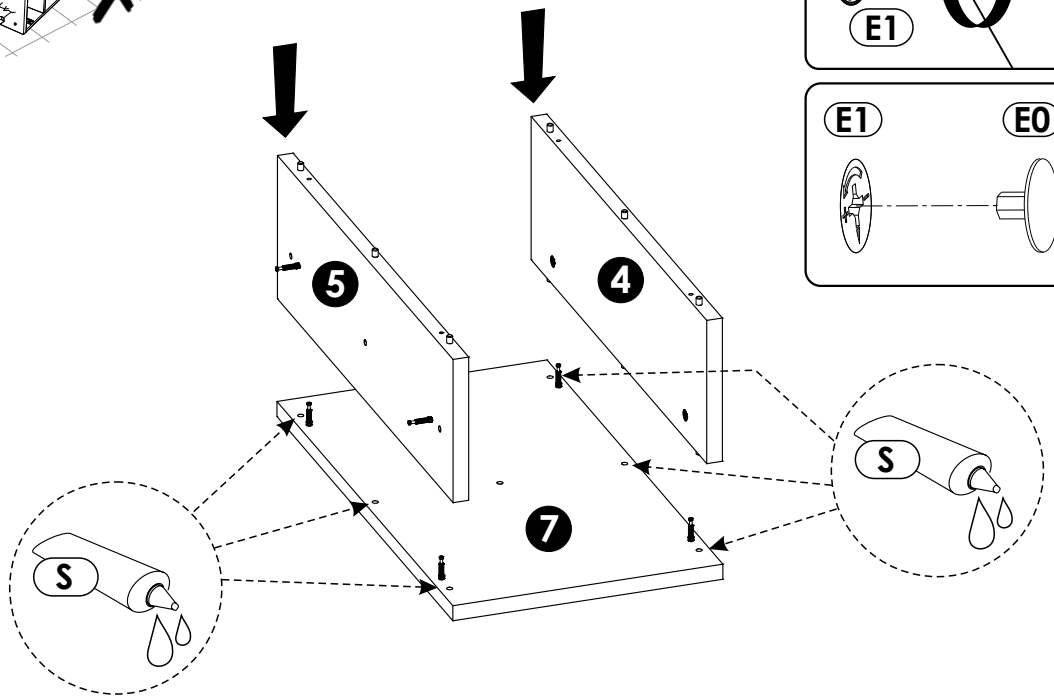
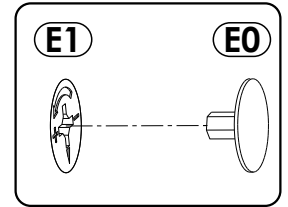
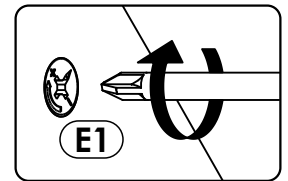
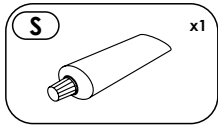
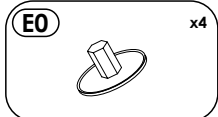
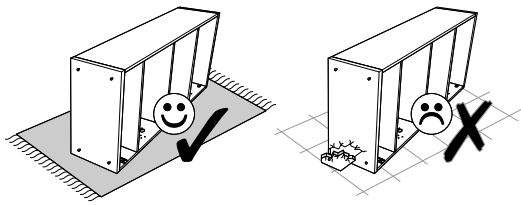

8 ▶

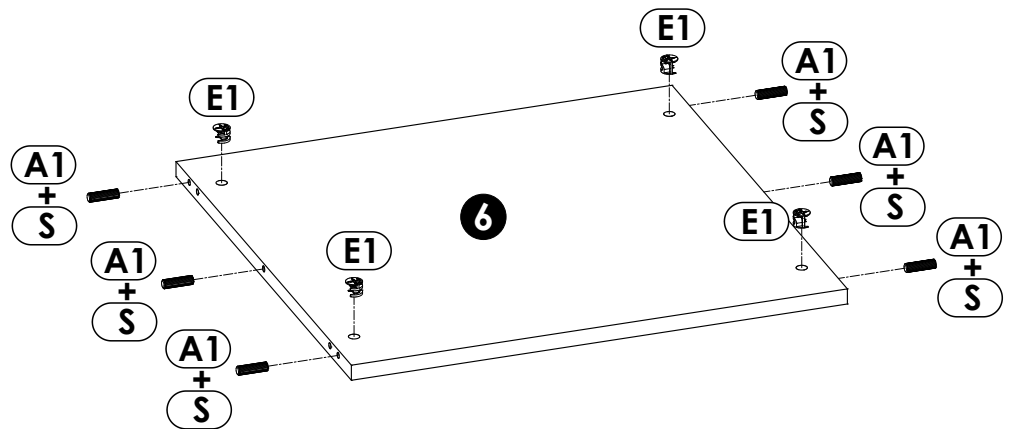
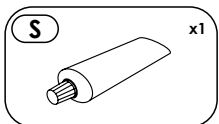
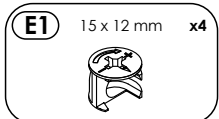
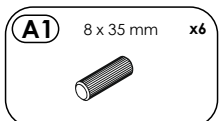
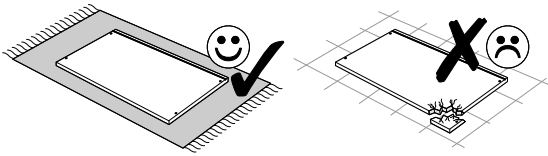

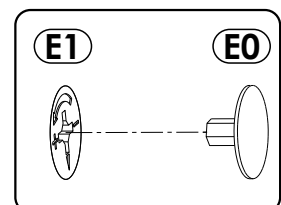
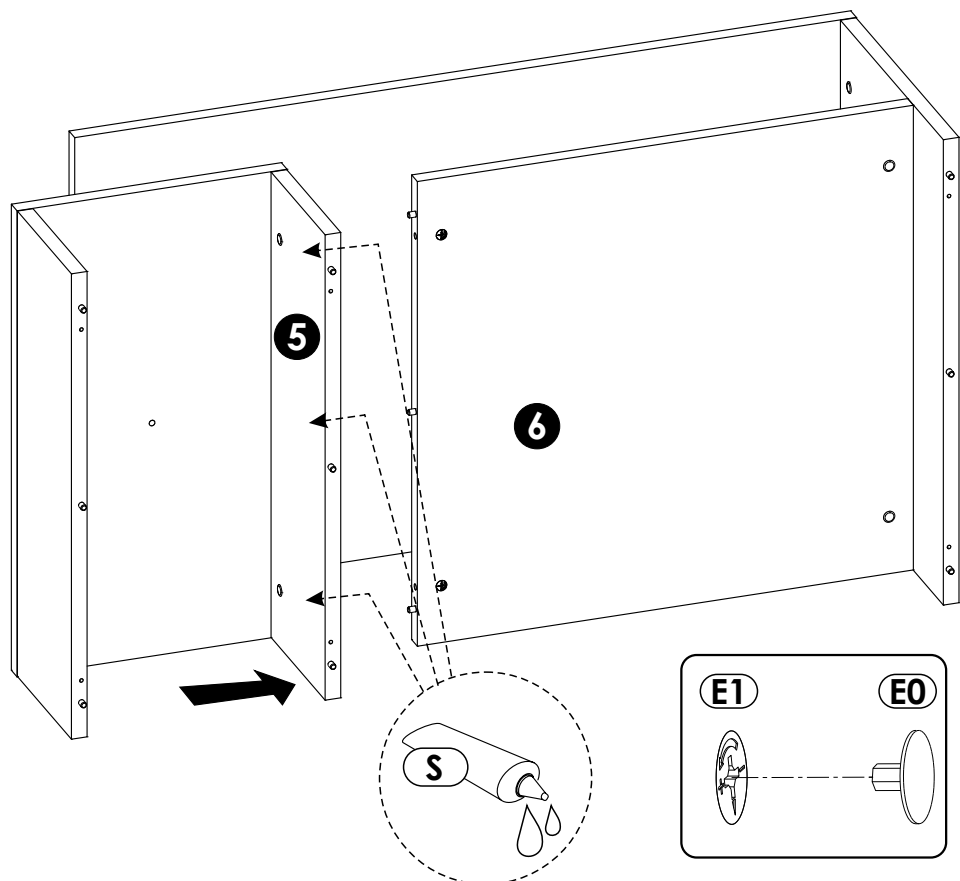
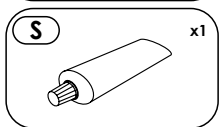
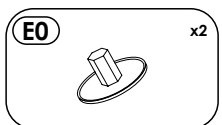
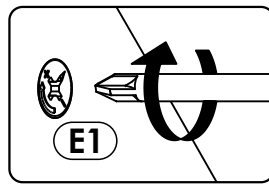
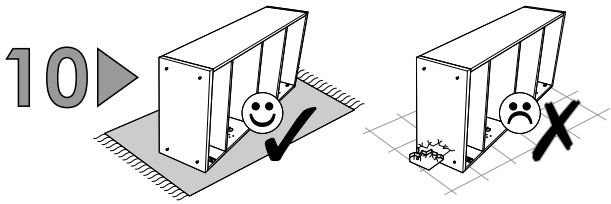
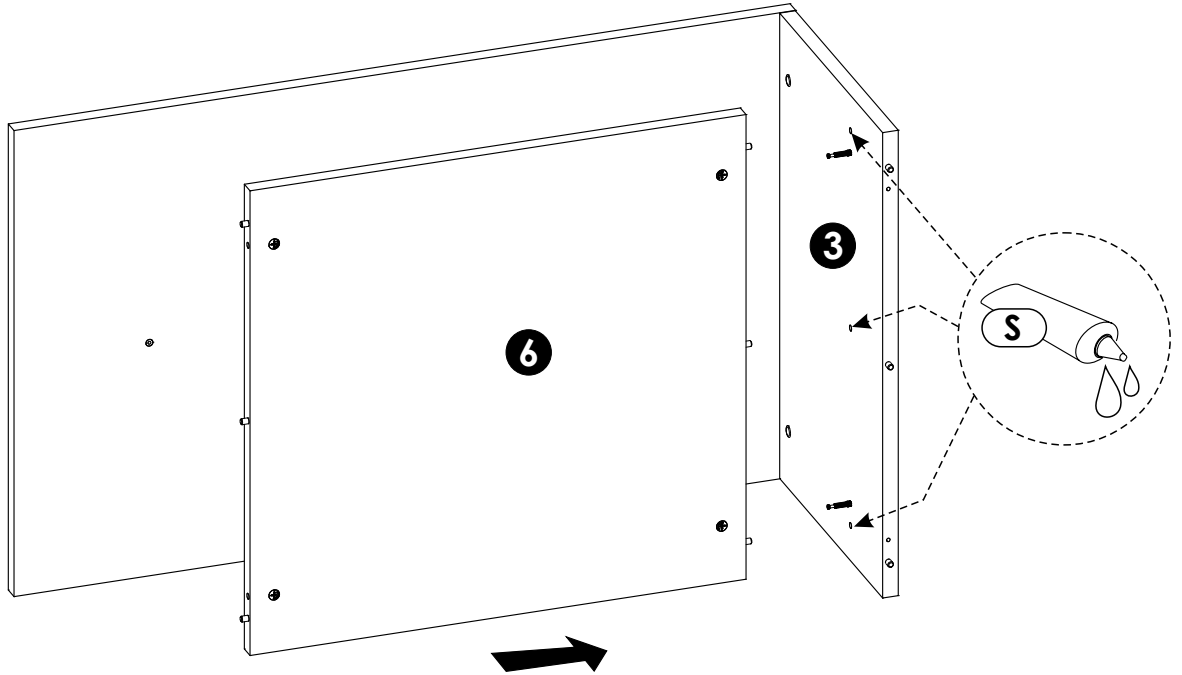
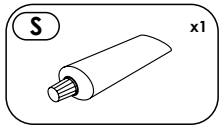
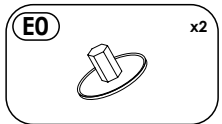
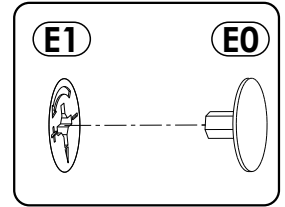
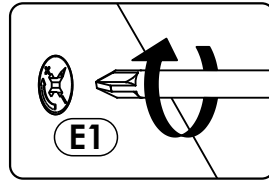
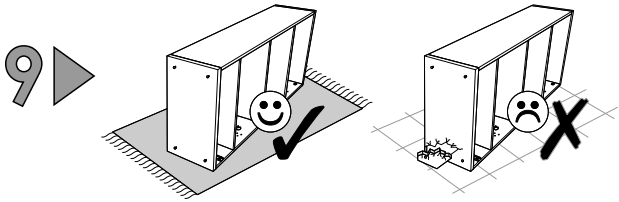

11 ▶

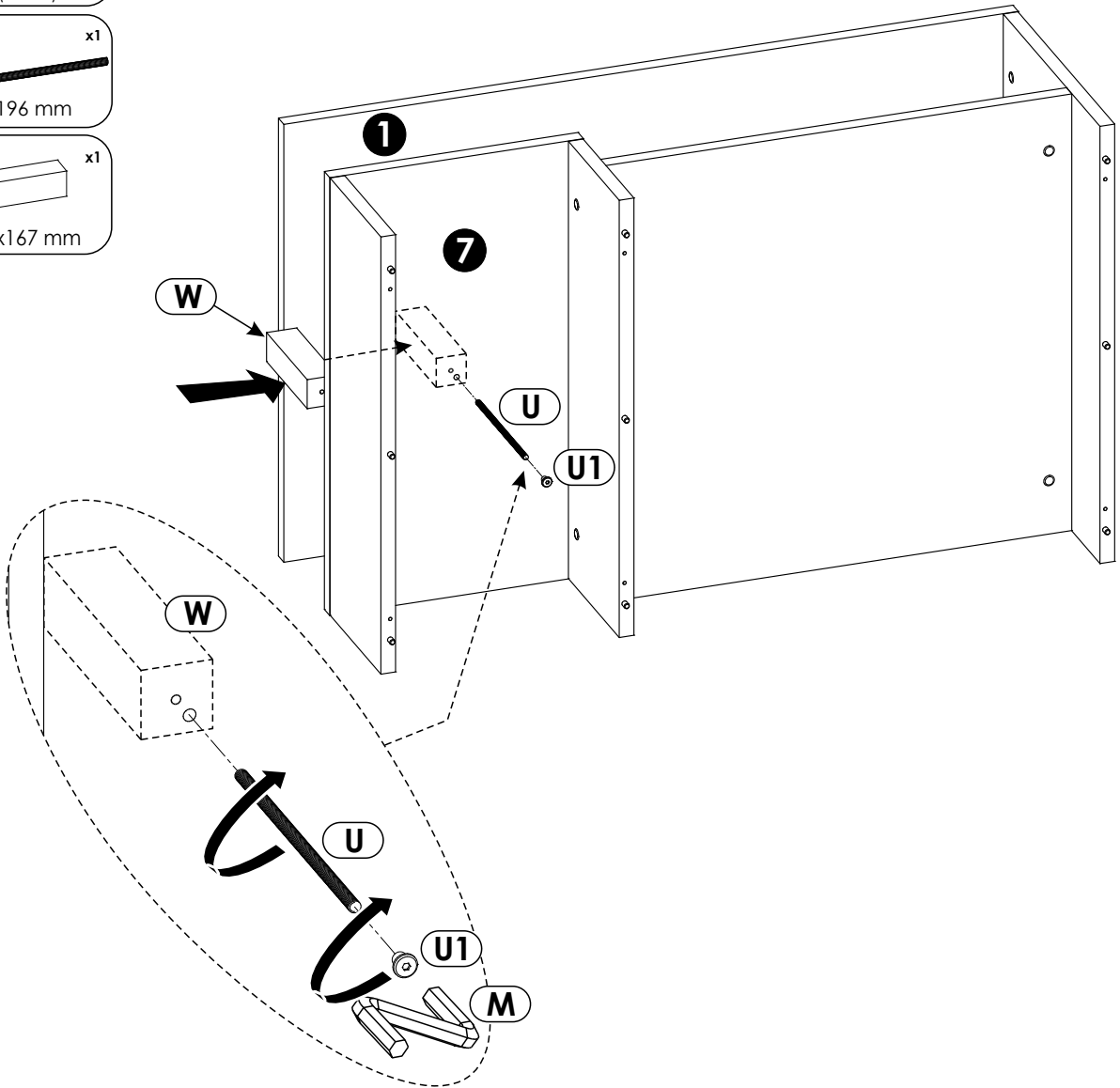
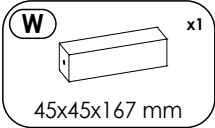
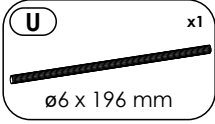
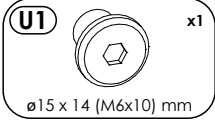
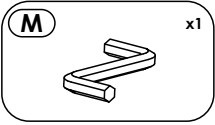
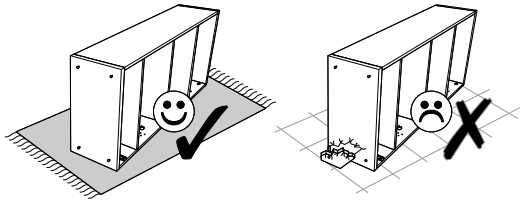

12▶

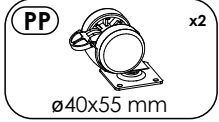
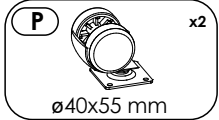
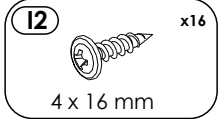
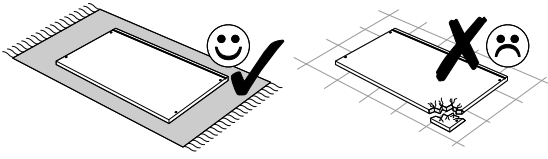

a.

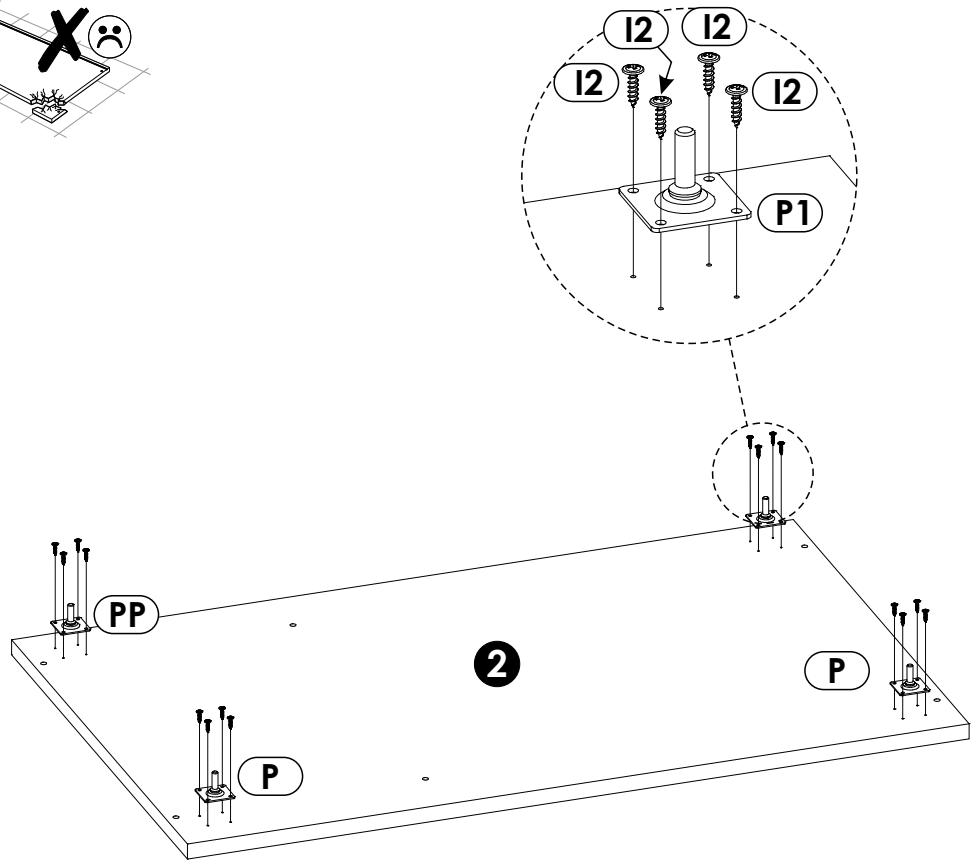

b.

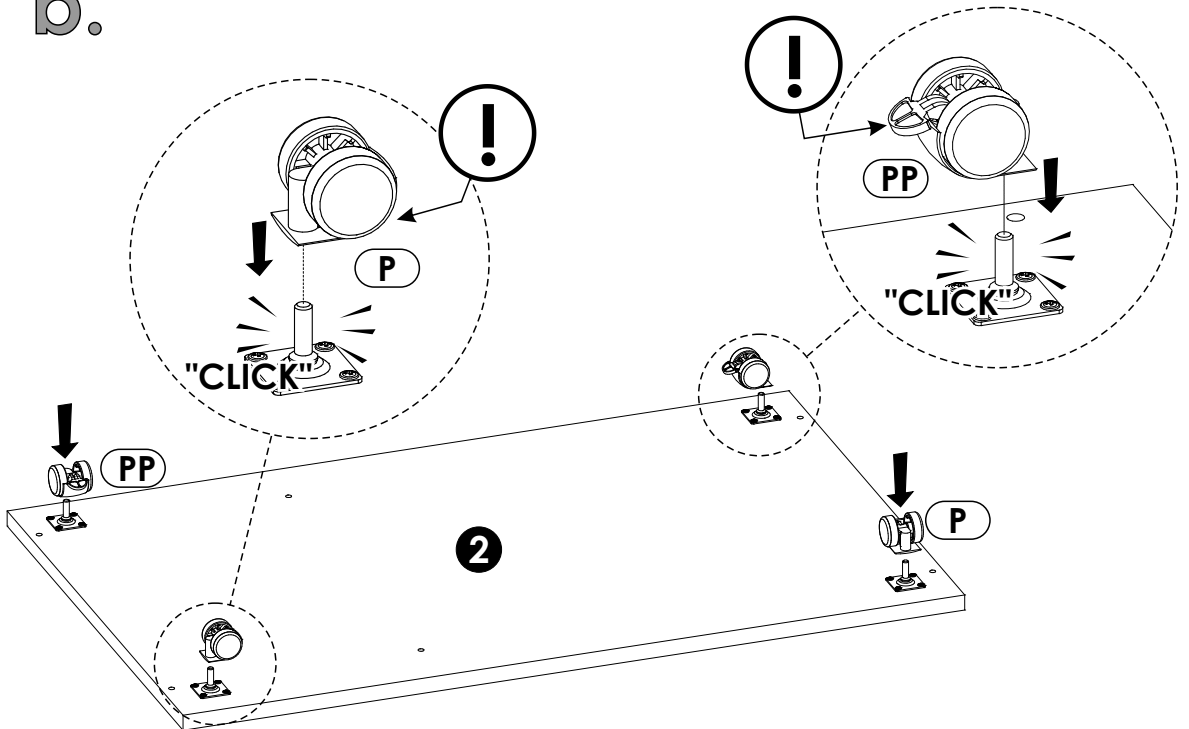

13 ▶

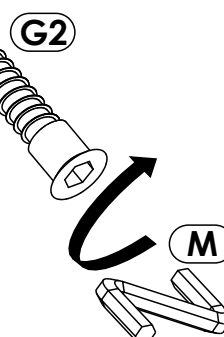
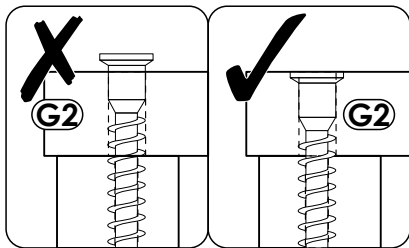
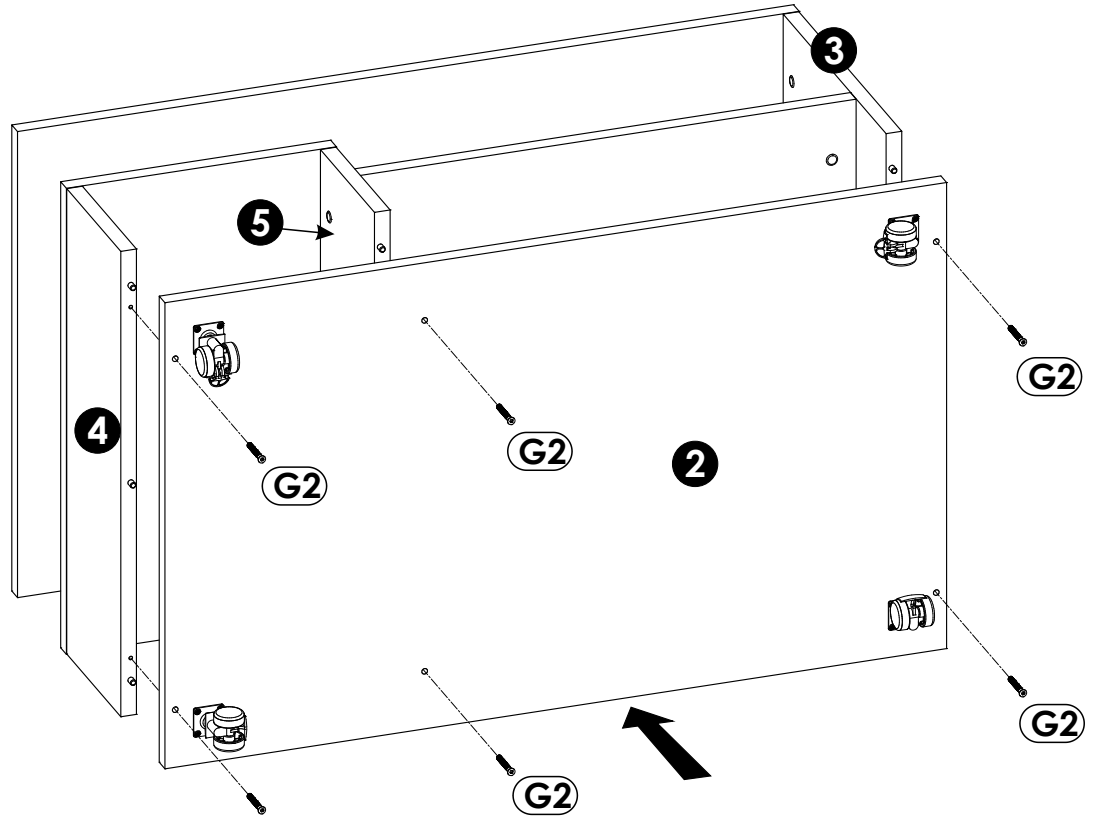
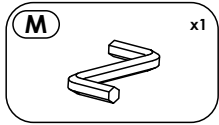
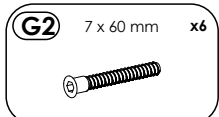
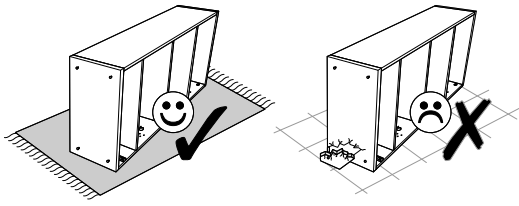

14▶

