

Montážní/Montážny návod		1/1
D40SZ_	Je potřebné použiť kladivo a skrutkovač Je třeba použít kladivo a šroubovák	
Promo	Skrinky montujte podľa krokov v montážnom návode Skříňky montujte podle kroků v montážním návodu	
260cm		

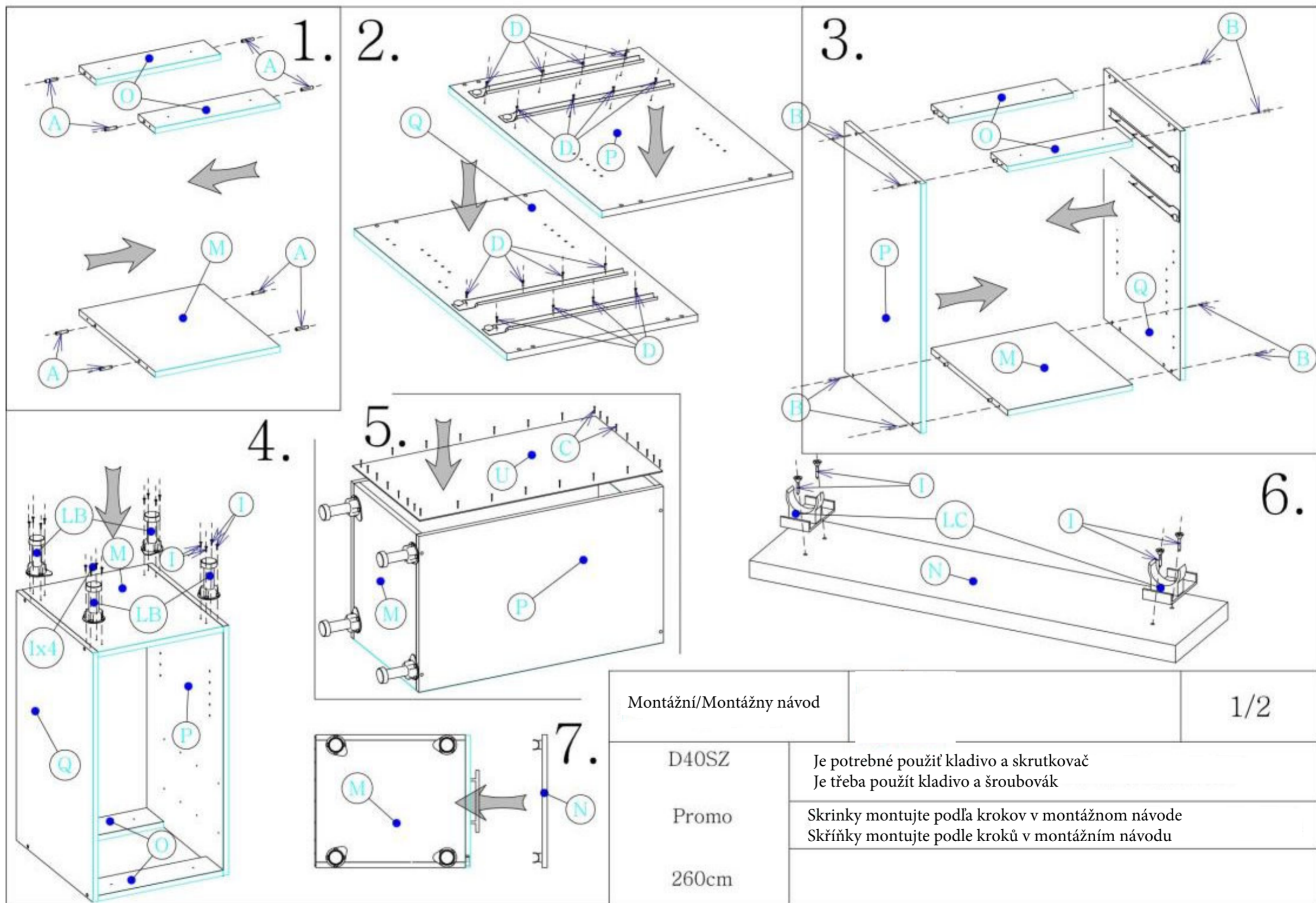

Montážní/Montážny návod		1/2
D40SZ	Je potřebné použít kladivo a skrutkovač Je třeba použít kladivo a šroubovák	
Promo	Skrinky montujte podľa kroků v montážnom návode Skříňky montujte podle kroků v montážním návodu	
260cm		

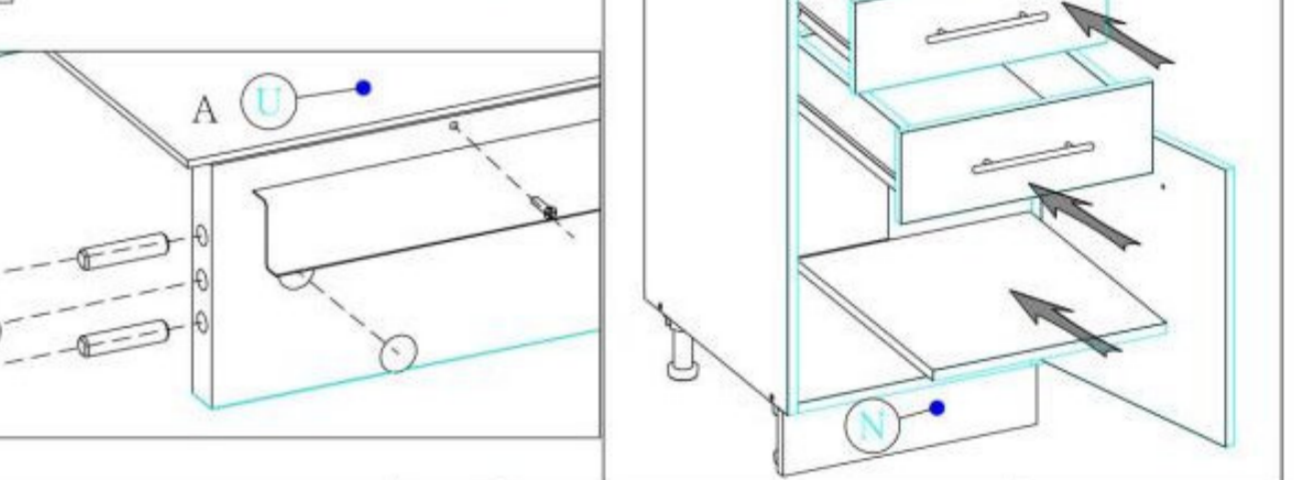
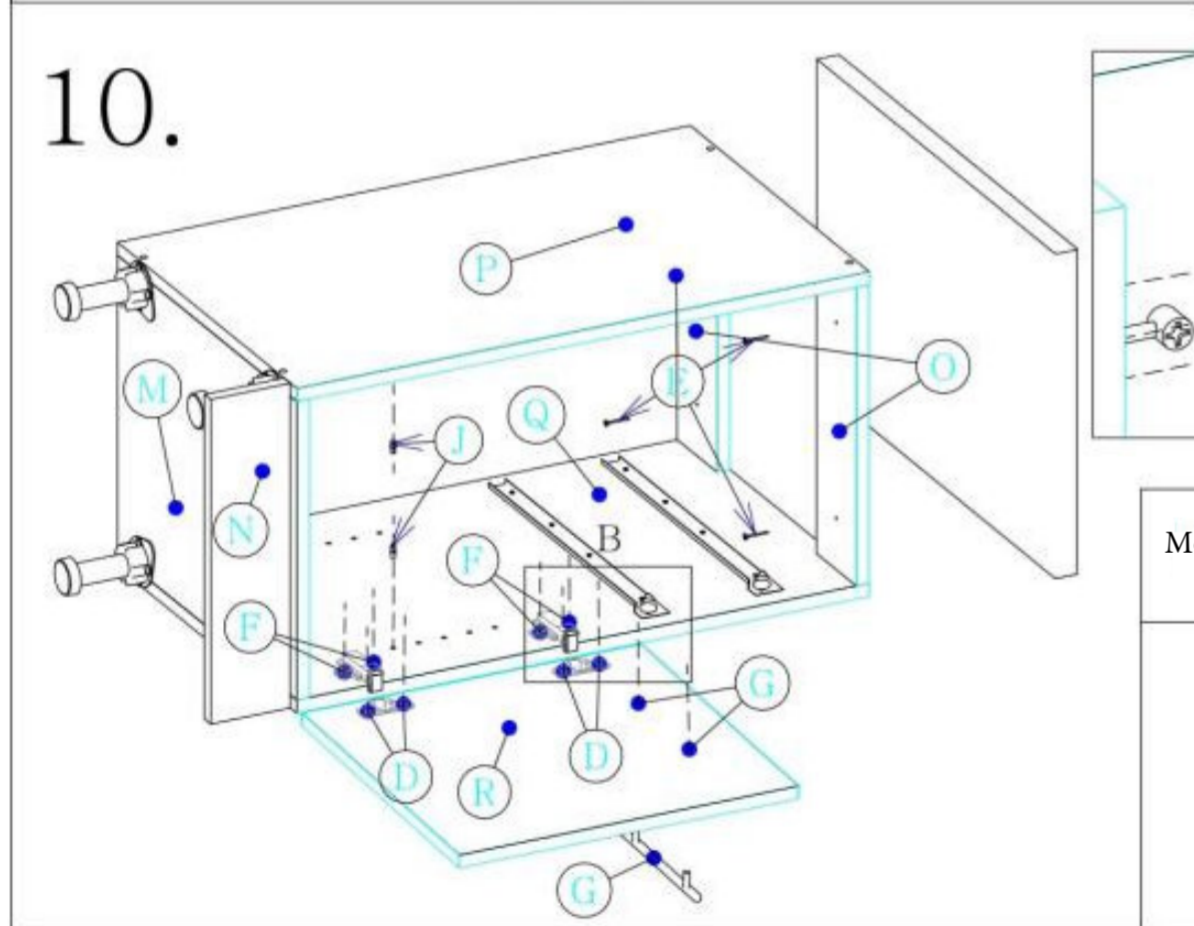
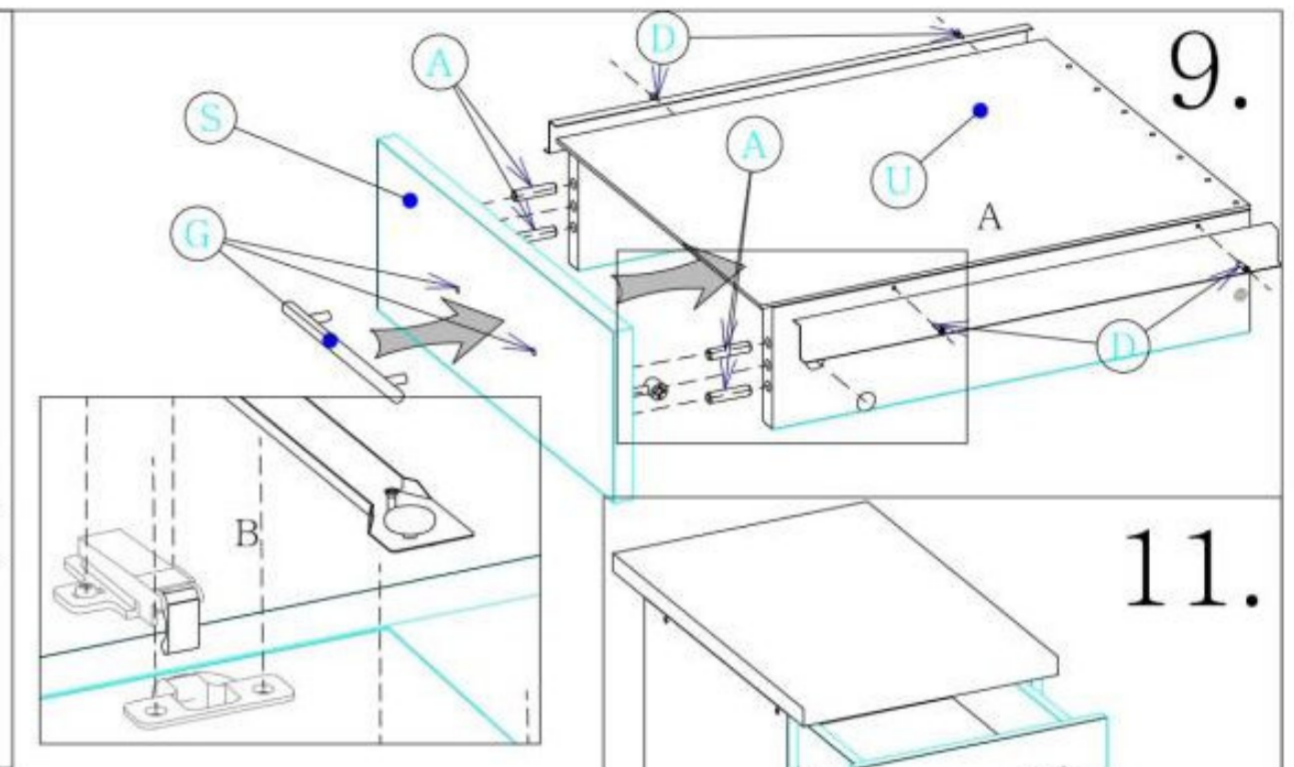
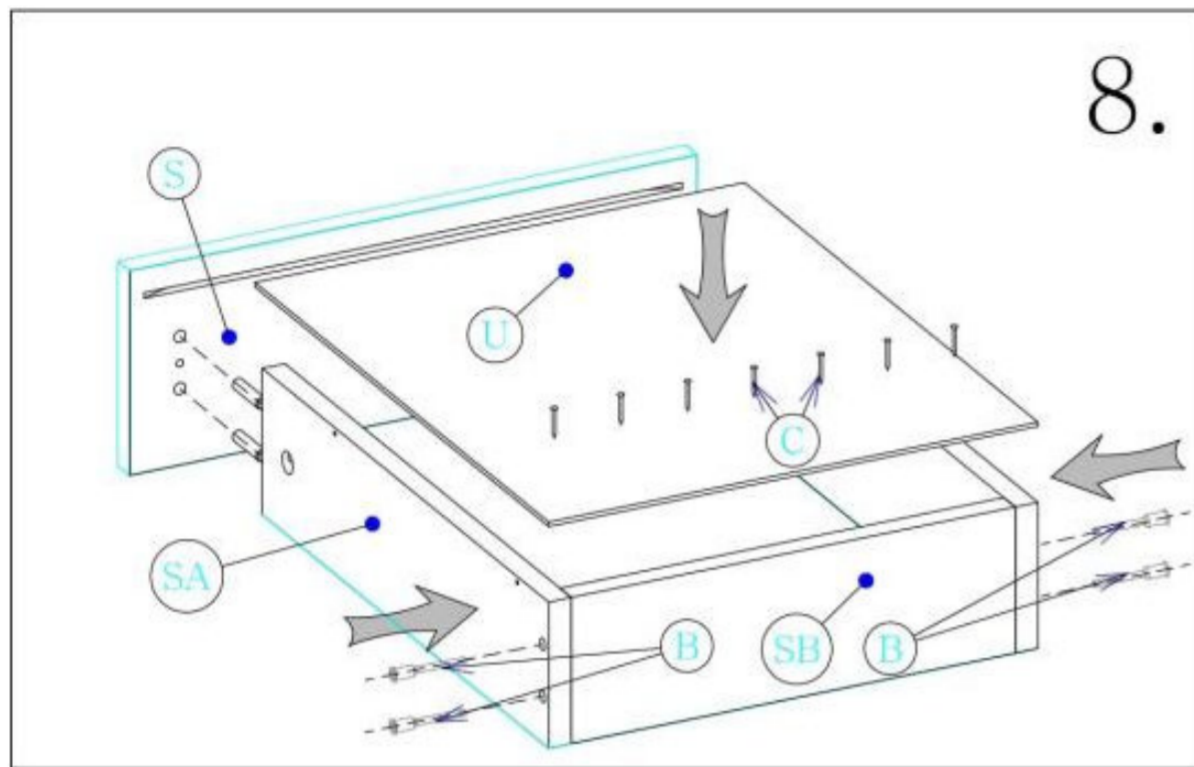

Montážní/Montážny návod		2/2
D40SZ	Je potřebné použít kladivo a šroukovač Je třeba použít kladivo a šroubovák	
Promo	Skrinky montujte podľa kroků v montážnom návode Skříňky montujte podle kroků v montážním návodu	
260cm		

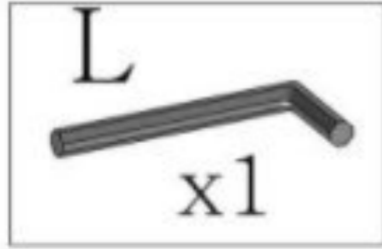
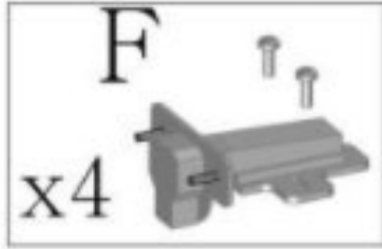
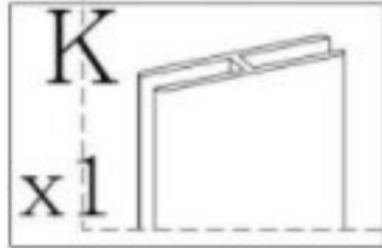
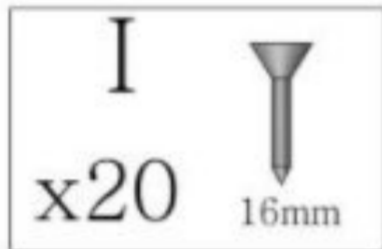
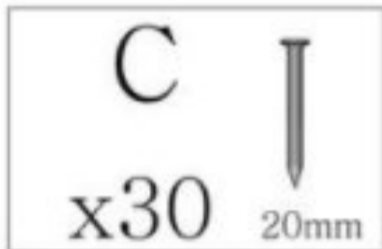
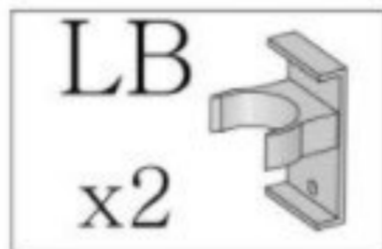
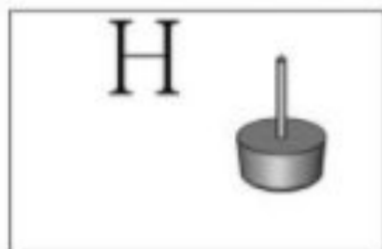
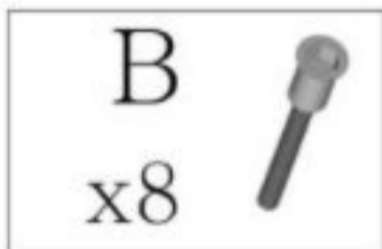
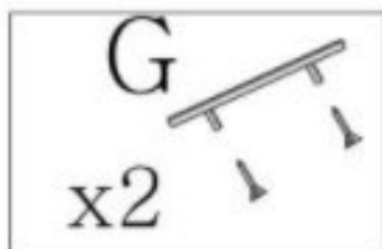
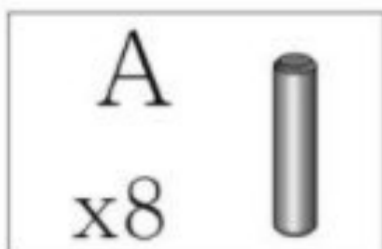

Montážní/Montážny návod		1/1
D80_	Je nutné použít kladivo a šroukovač Je třeba použít kladivo a šroubovák	
Promo	Skrinky montujte podľa kroků v montážním návode Skříňky montujte podle kroků v montážním návode	
260cm		

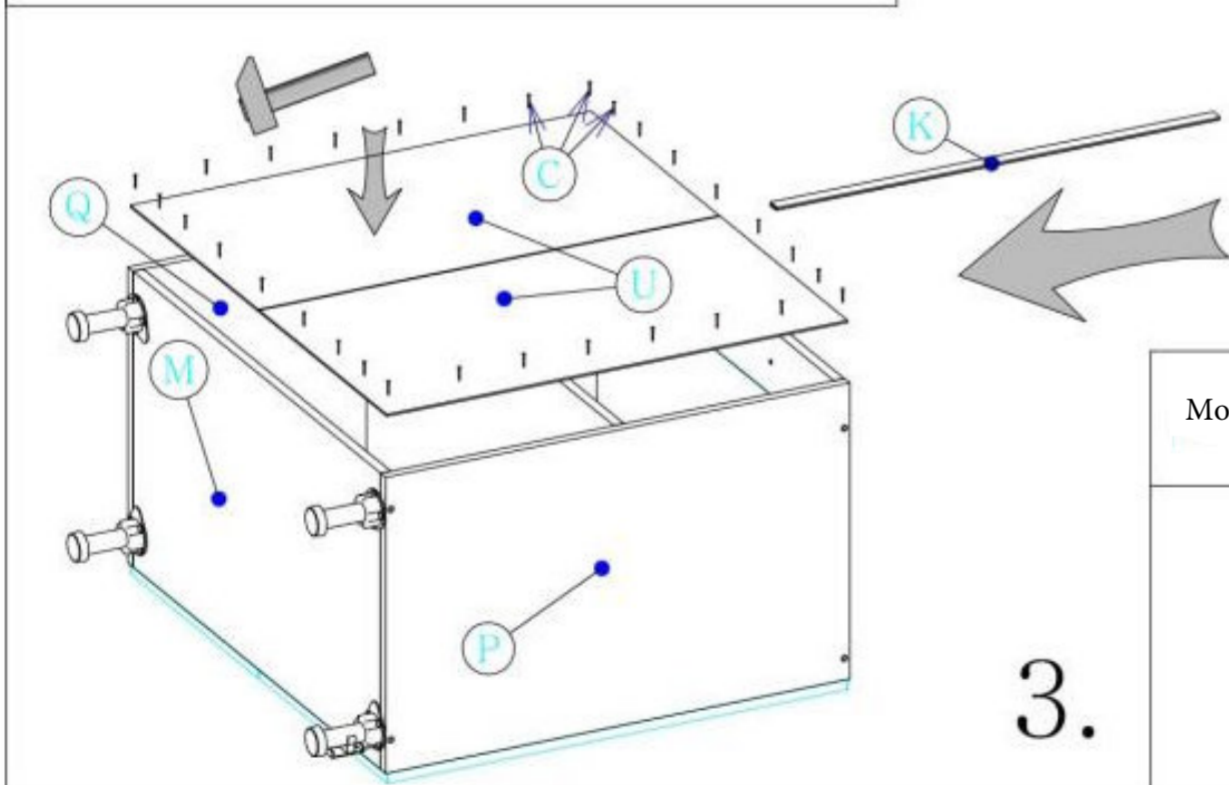
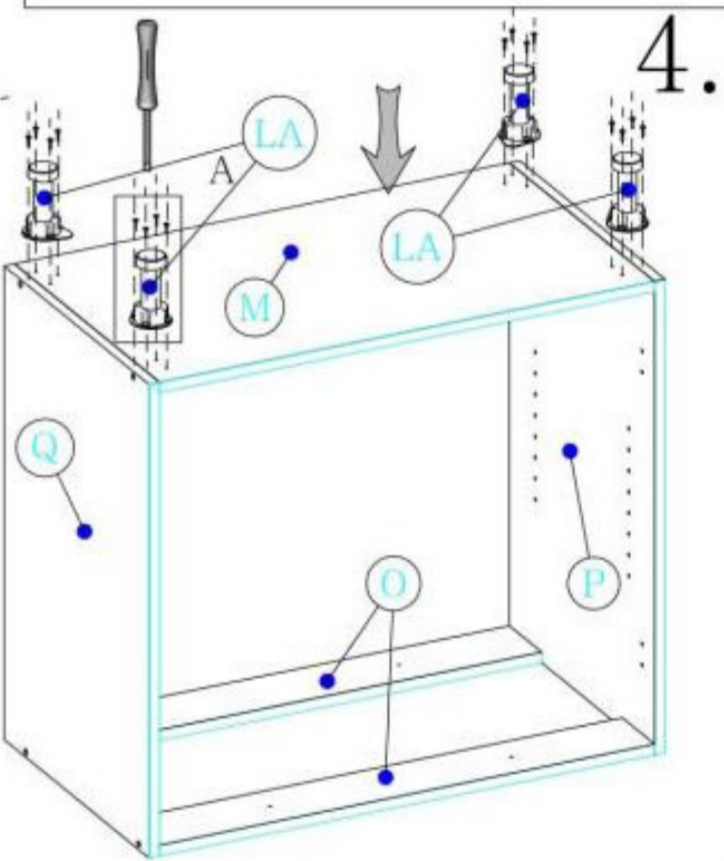
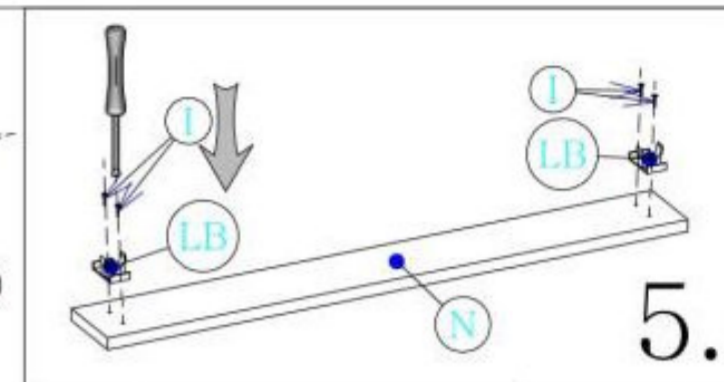
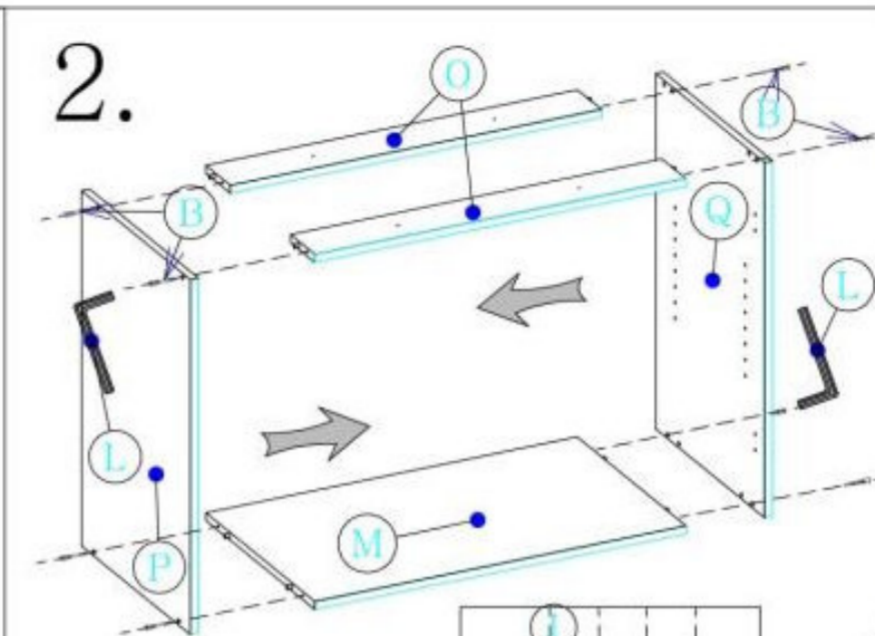
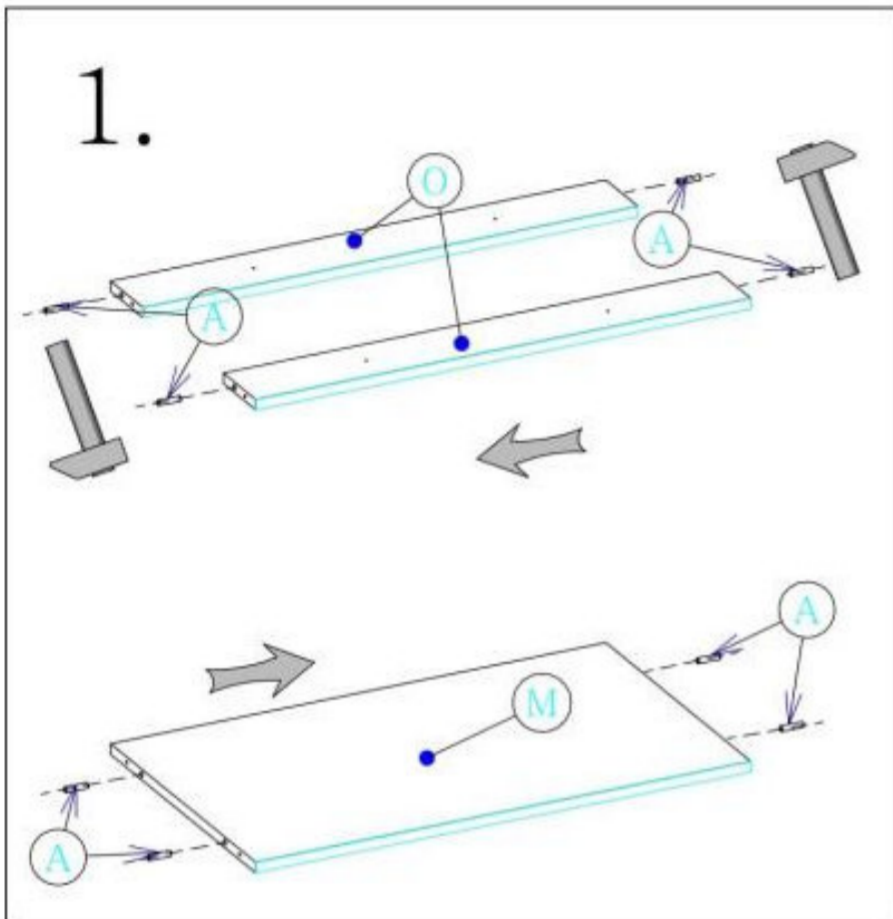

Montážní/Montážny návod		1/2
D80	Je potřebné použiť kladivo a skrutkovač Je třeba použít kladivo a šroubovák	
Promo	Skrínky montujte podľa kroků v montážnom návode Skrínky montujte podle kroků v montážním návodu	
260cm		

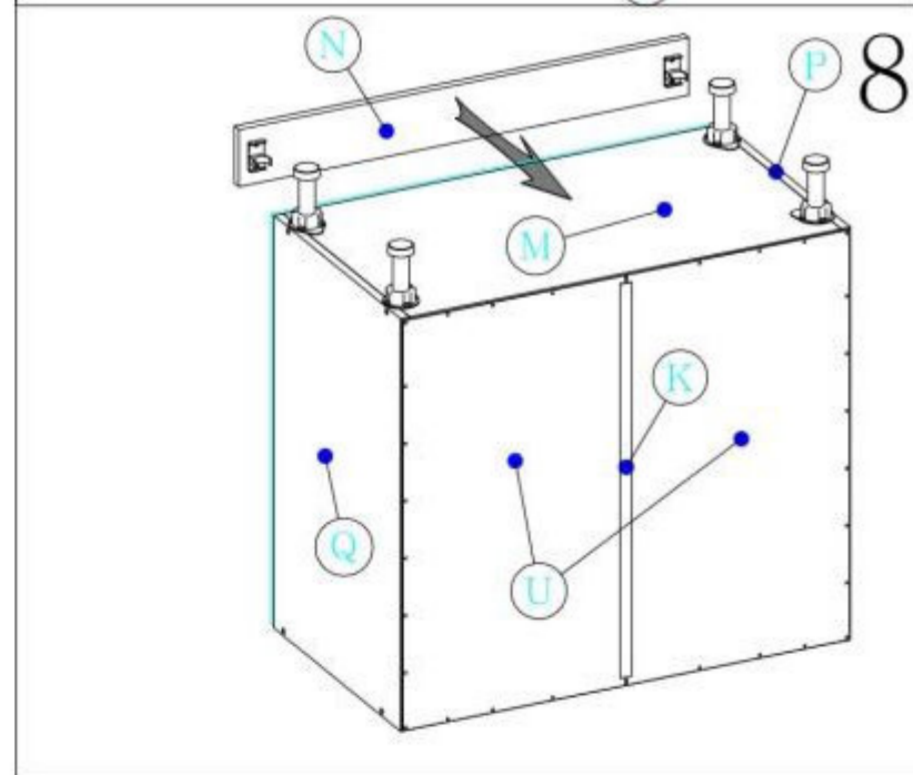
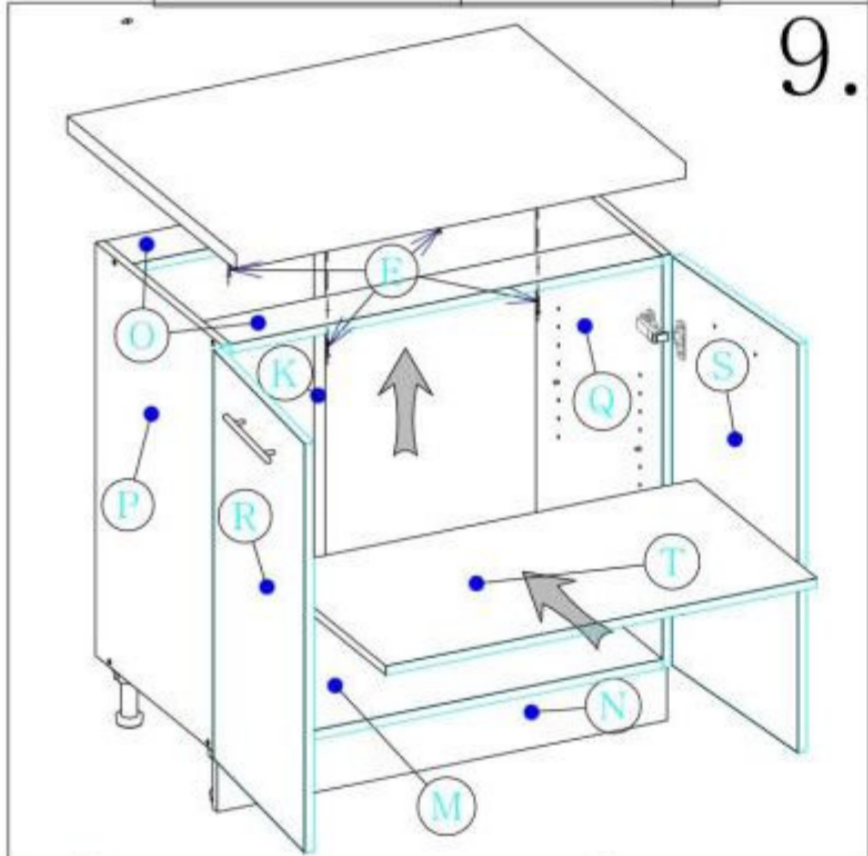
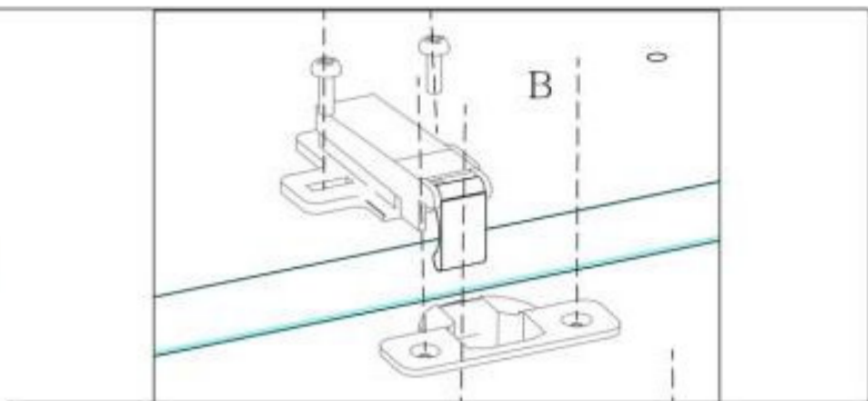
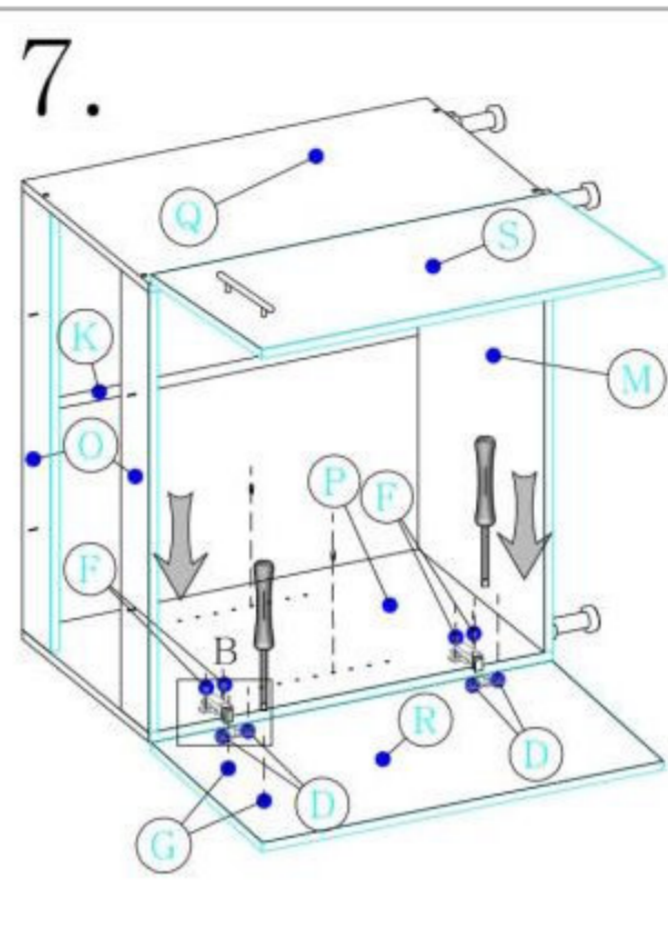
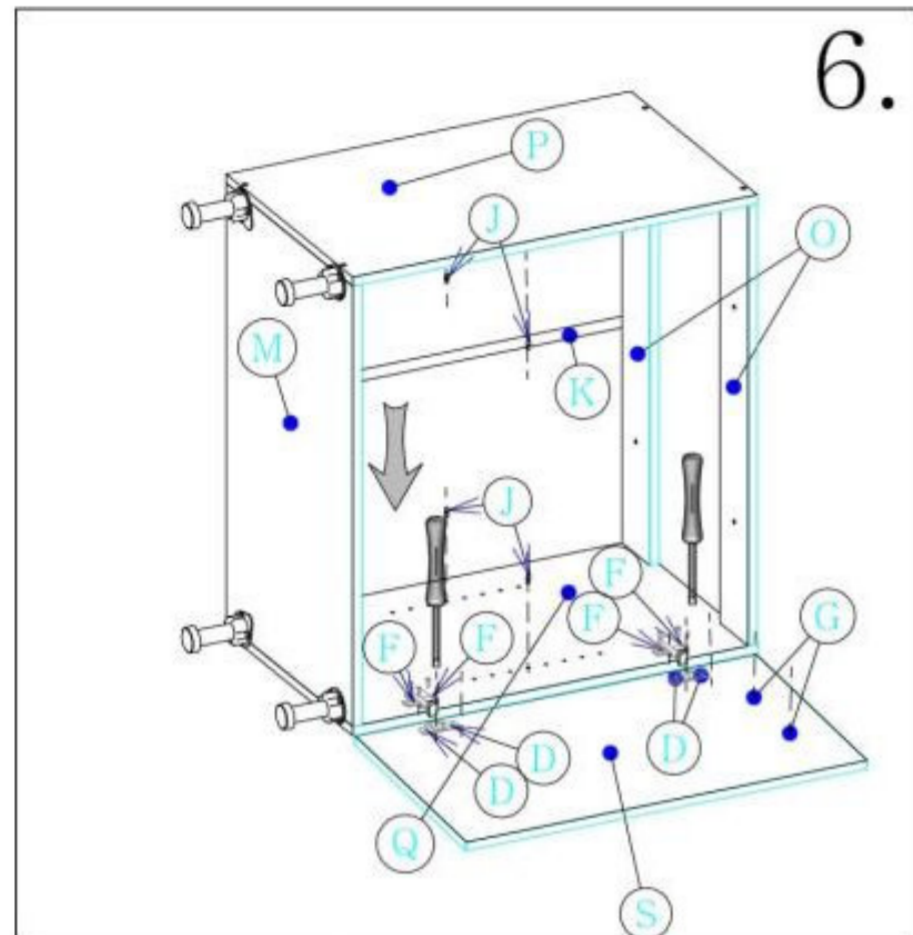

Montážní/Montážny návod		2/2
D80	Je potrebné použiť kladivo a skrutkovač Je třeba použiť kladivo a šroubovák	
Promo	Skrinky montujte podľa krokov v montážnom návode Skříňky montujte podle kroků v montážním návodu	
260cm		

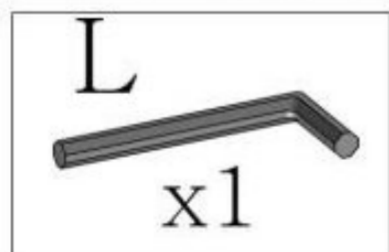
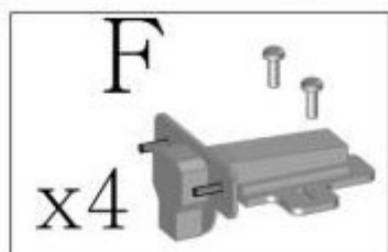
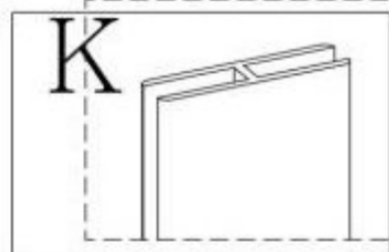
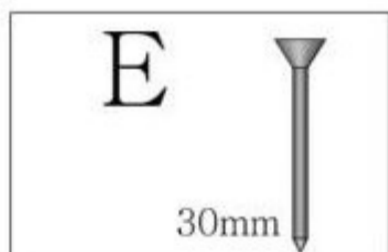
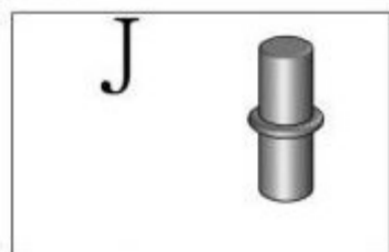
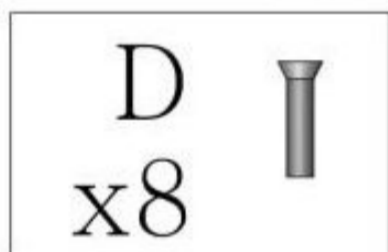
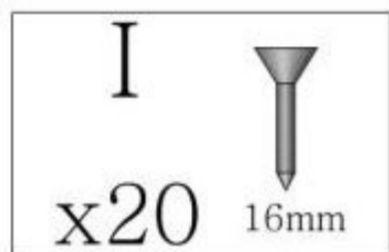
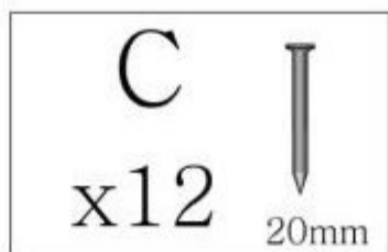
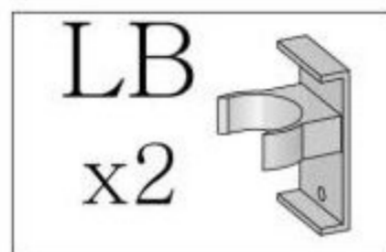
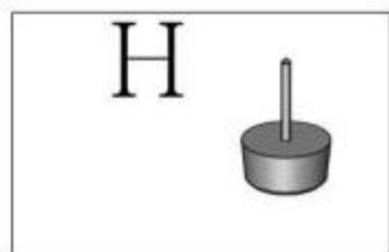
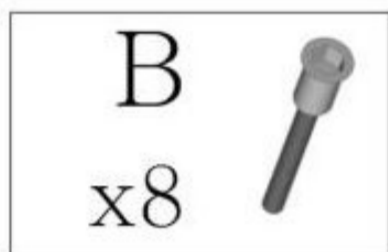
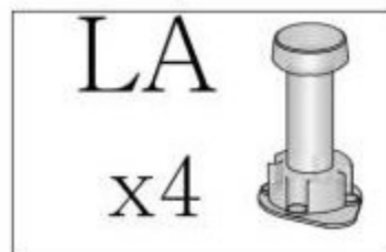
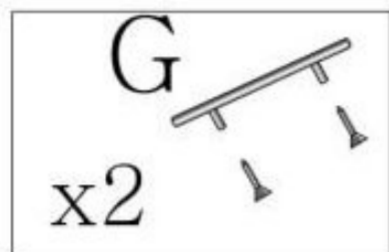
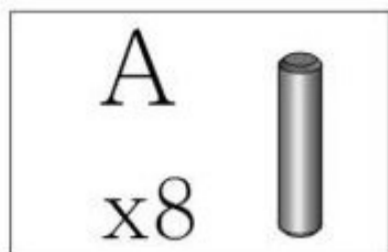

Montážní/Montážny návod		1/1
D80ZL_	Je potřebné použiť kladivo a skrutkovač Je třeba použít kladivo a šroubovák	
Promo	Skrinky montujte podľa kroků v montážnom návode Skříňky montujte podle kroků v montážním návodu	
260cm		

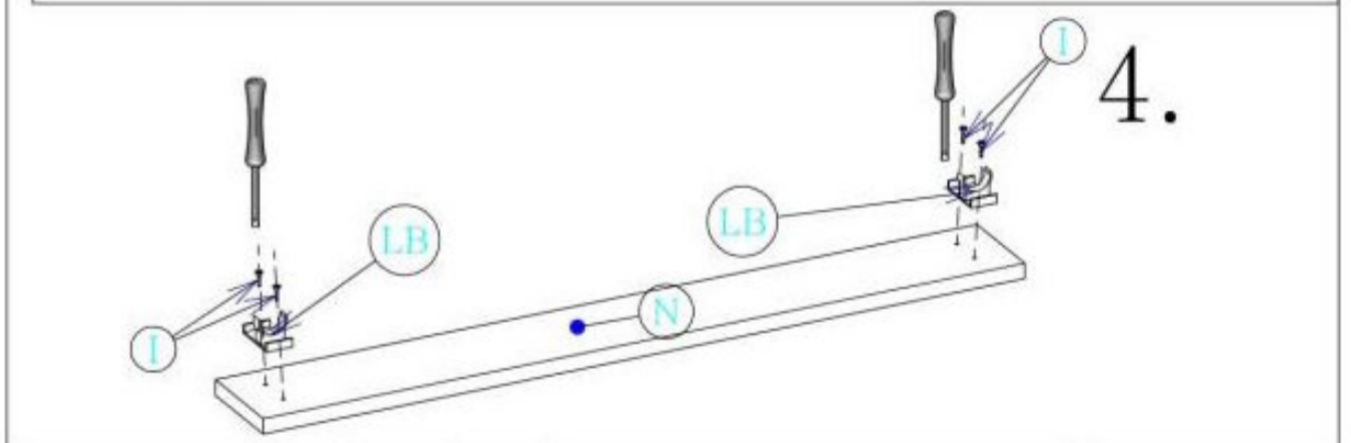
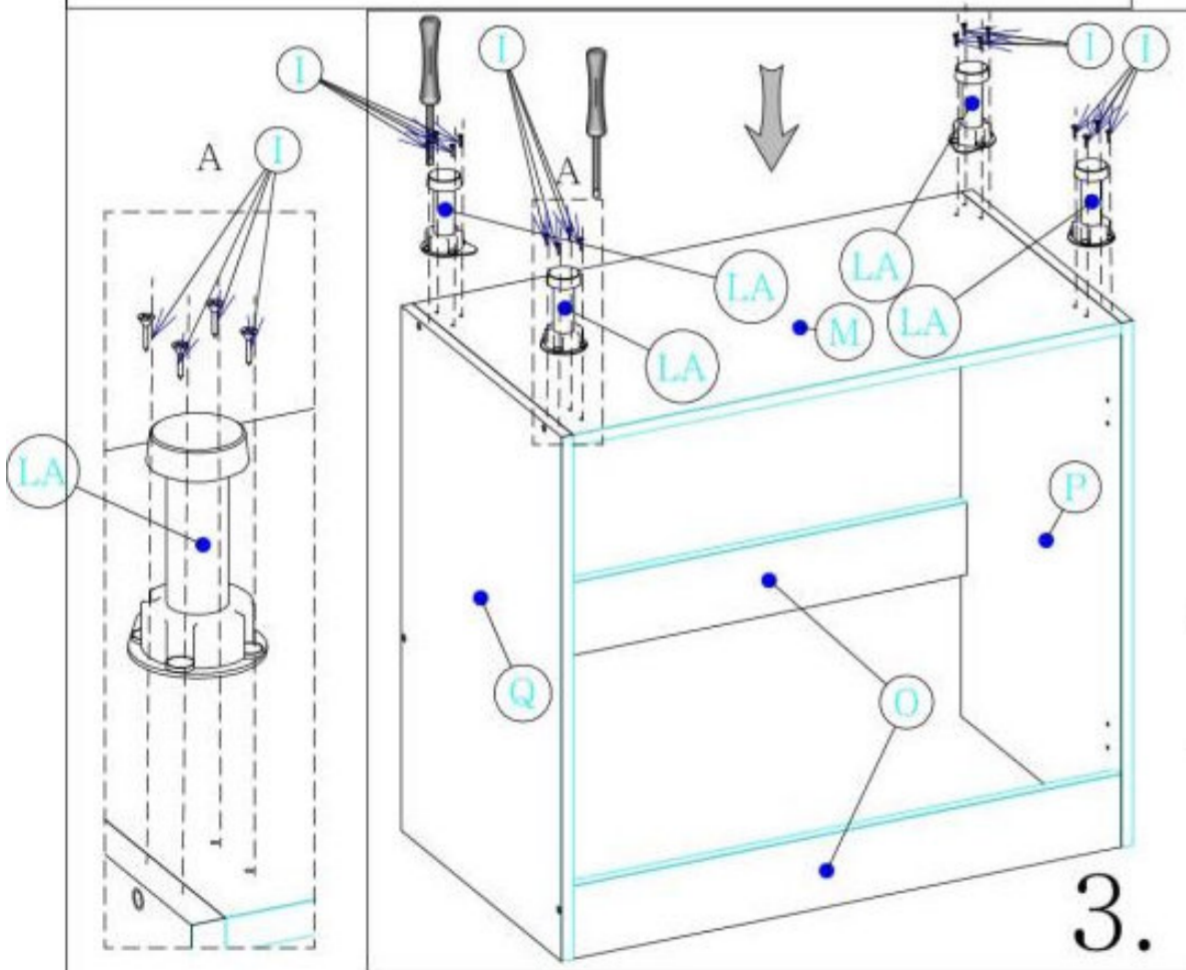
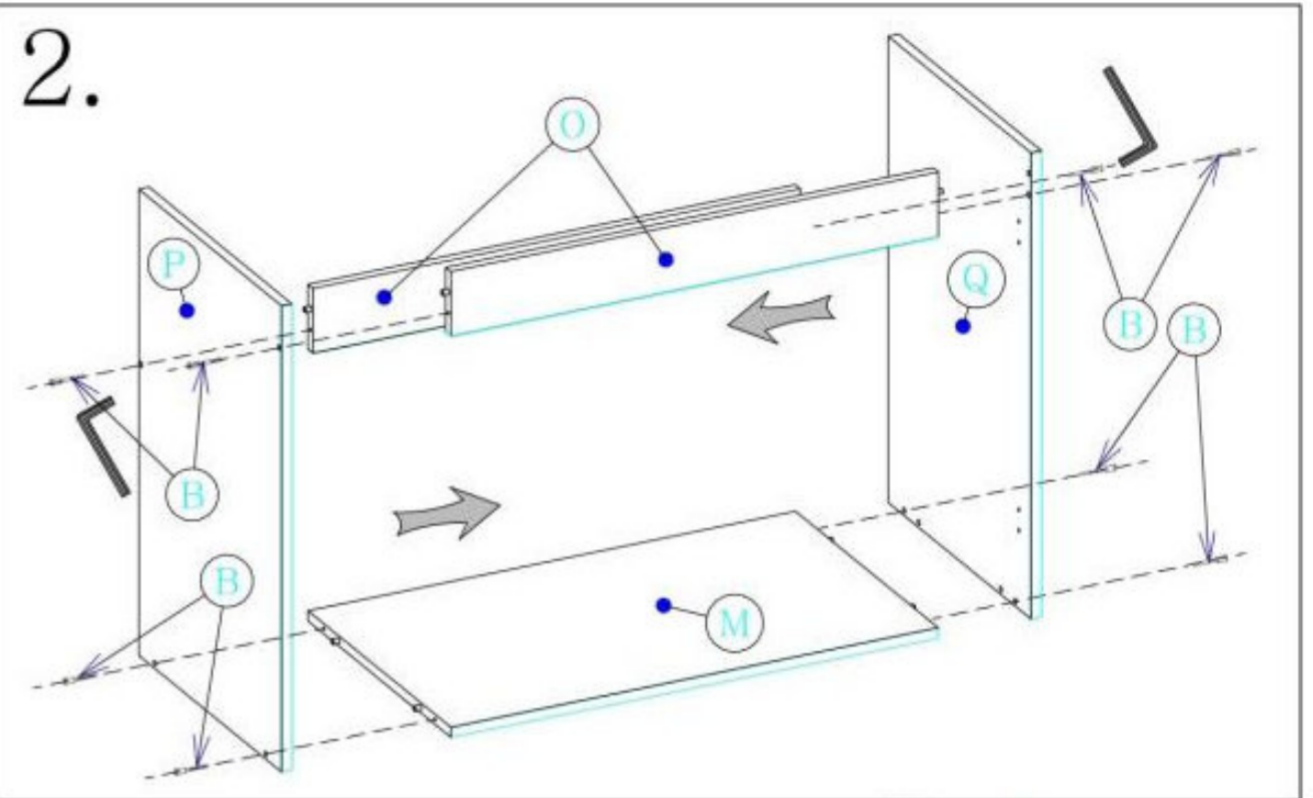
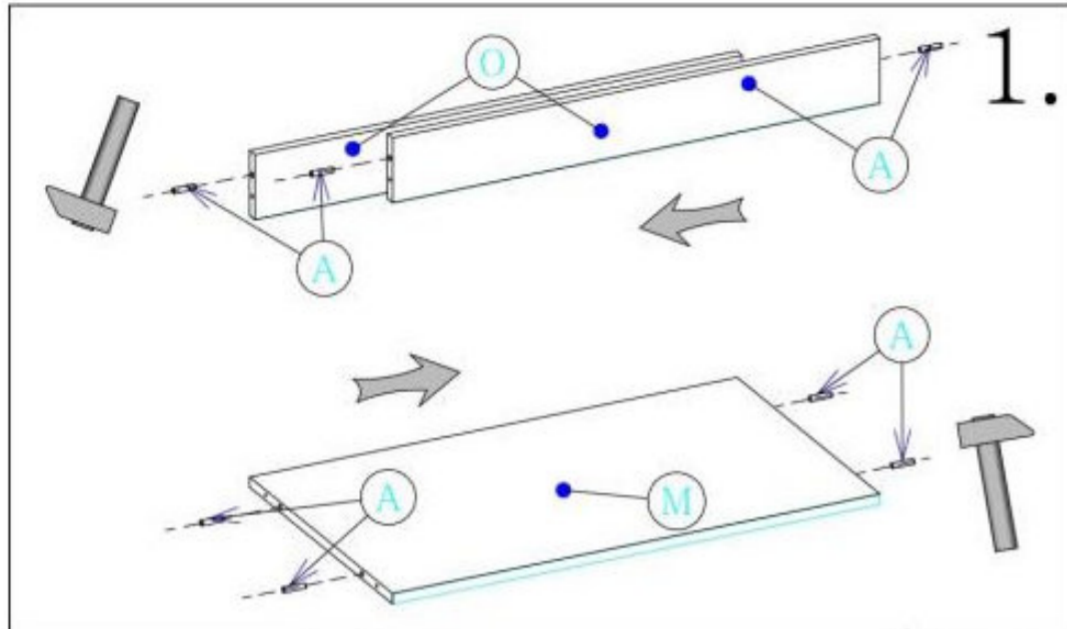

Montážní/Montážny návod		1/2
D80ZL	Je potřebné použít kladivo a skrutkovač Je třeba použít kladivo a šroubovák	
Promo	Skrinky montujte podľa kroků v montážnom návode Skříňky montujte podle kroků v montážním návodu	
260cm		

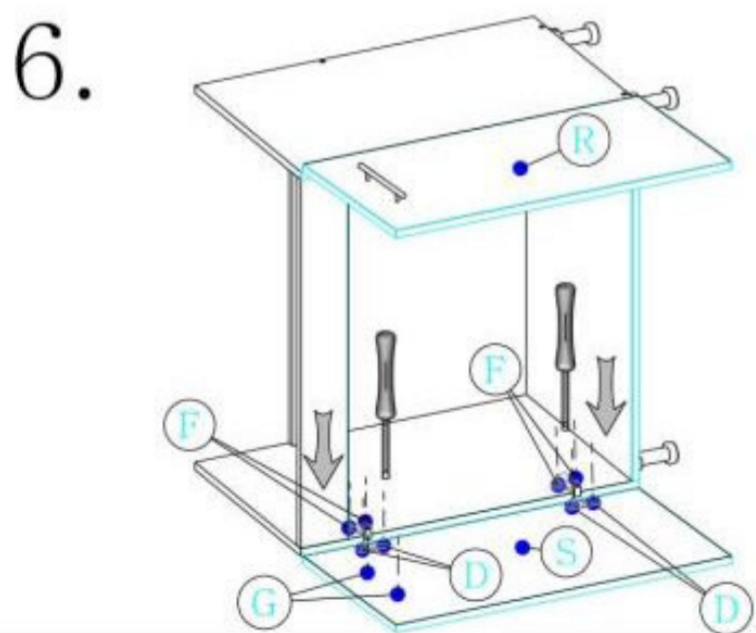
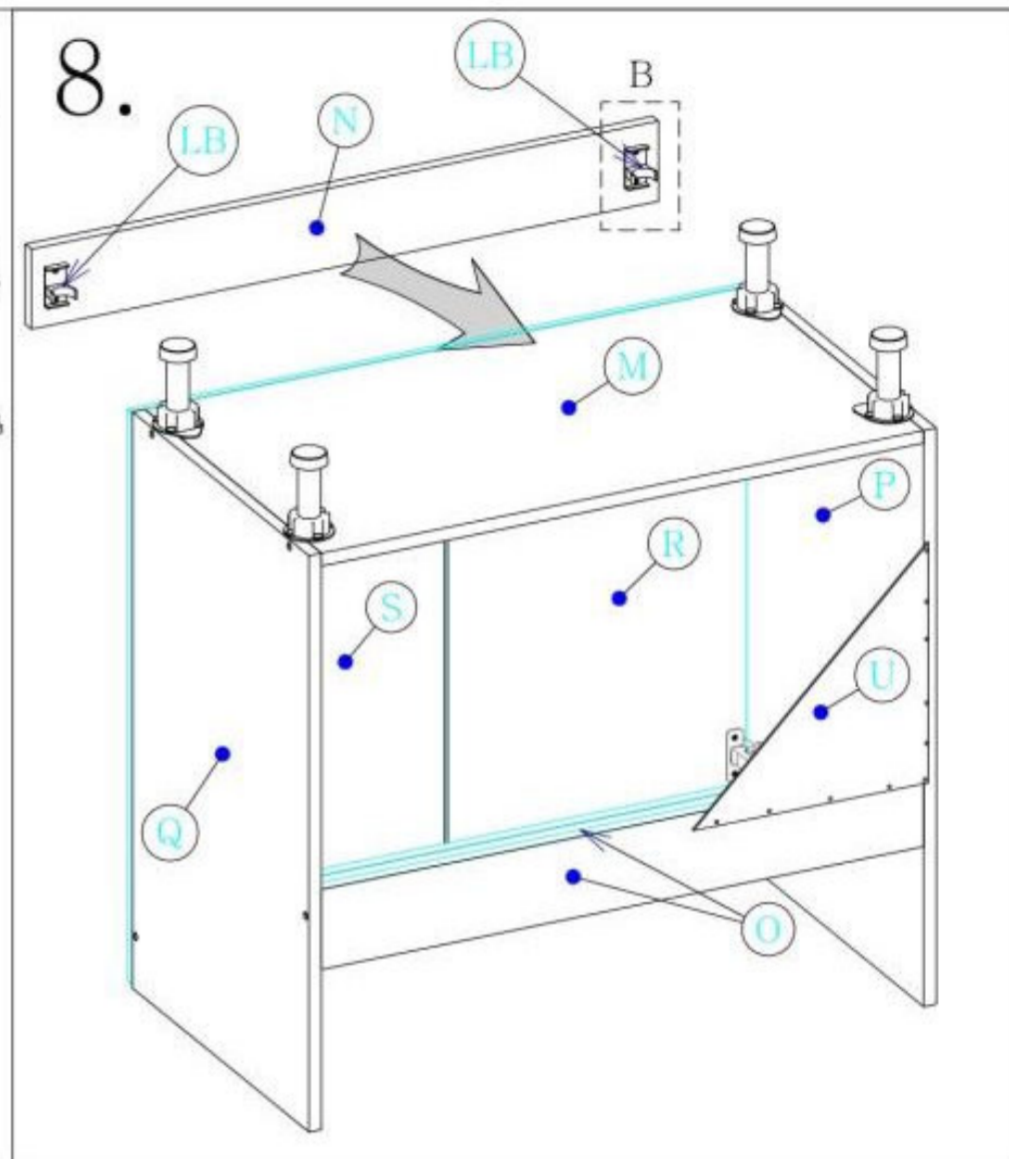
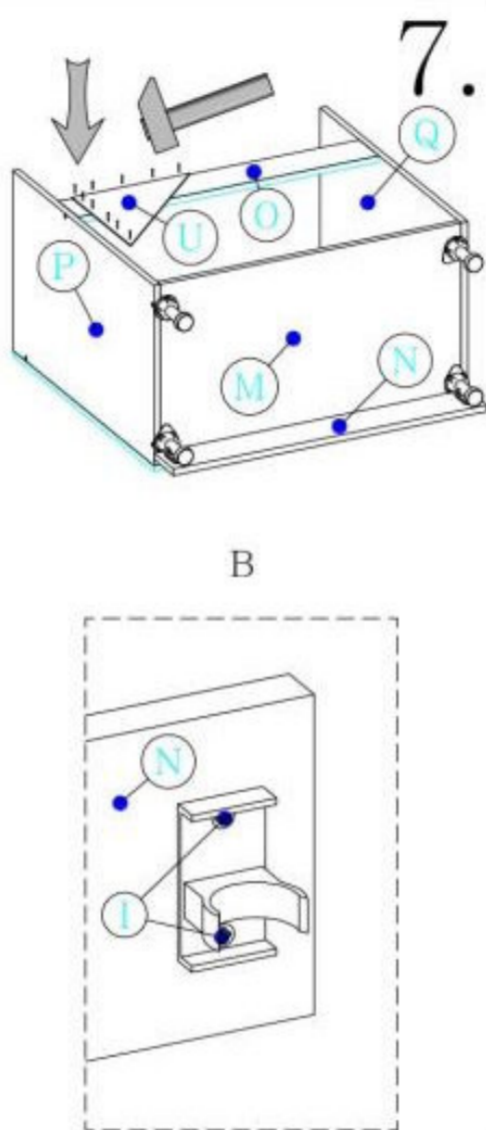
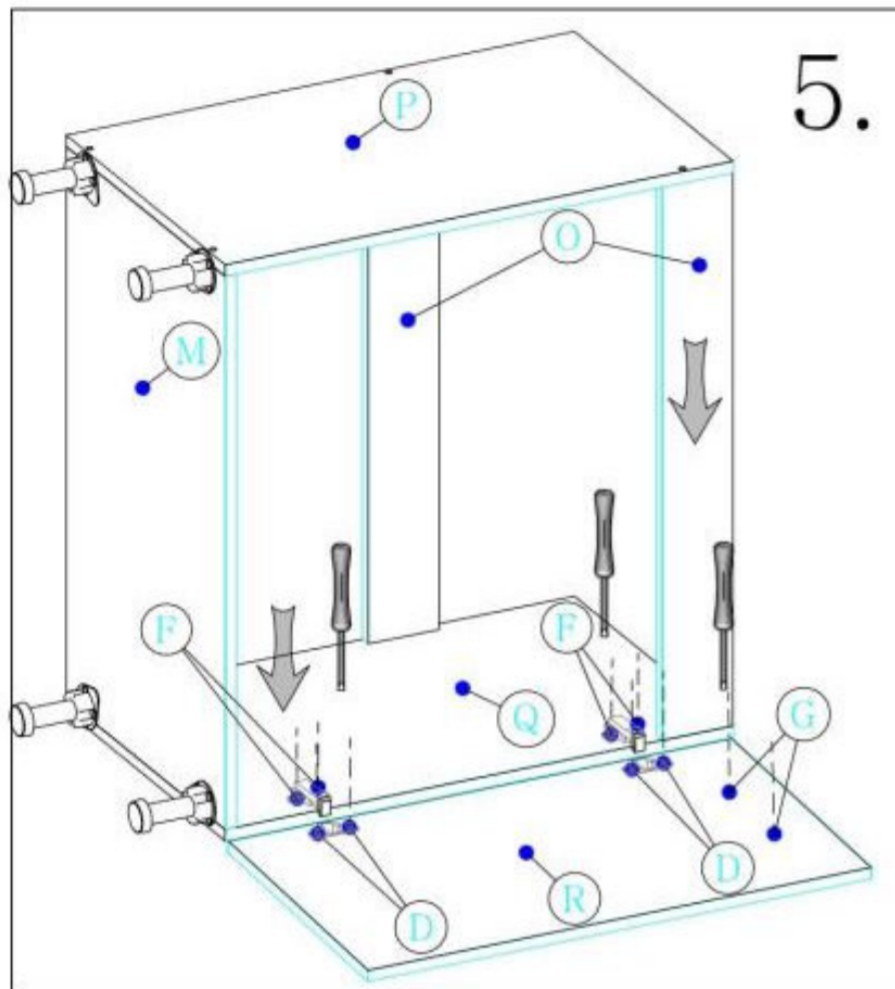

Montážní/Montážny návod		2/2
D80ZL	Je potřebné použít kladivo a škrutkovač Je třeba použít kladivo a šroubovák	
Promo	Skrinky montujte podľa kroků v montážnom návode Skřínky montujte podle kroků v montážním návodu	
260cm		

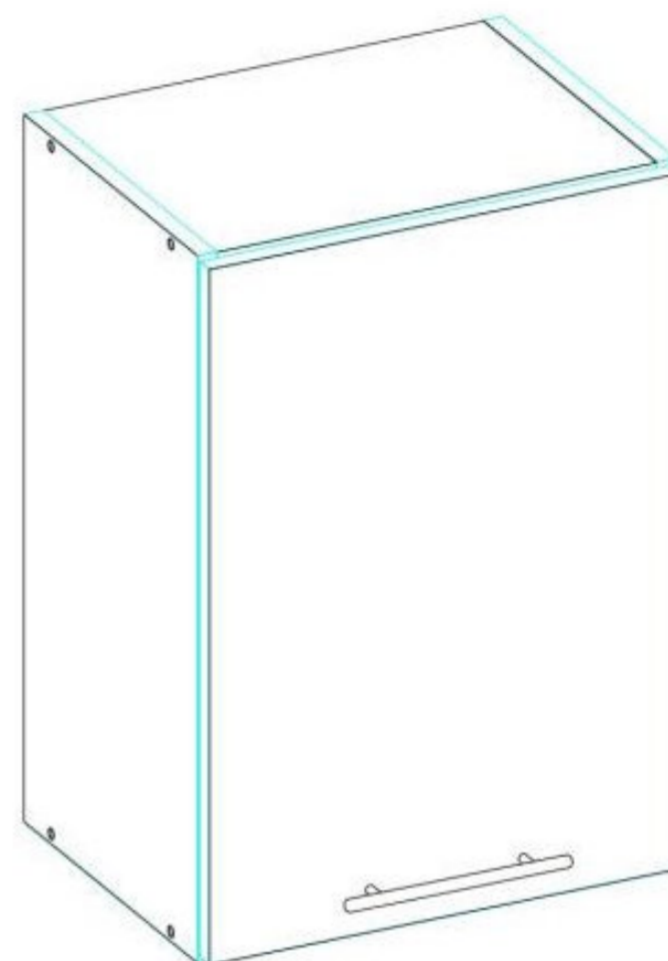
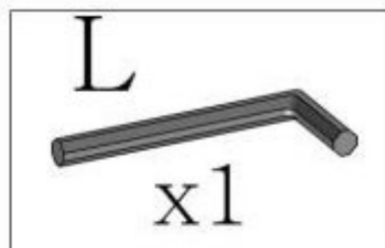
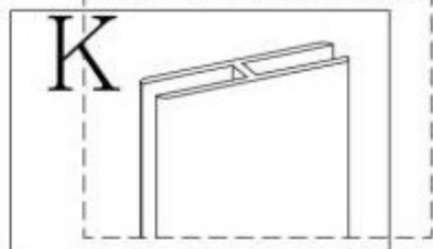
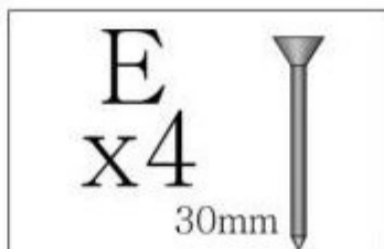
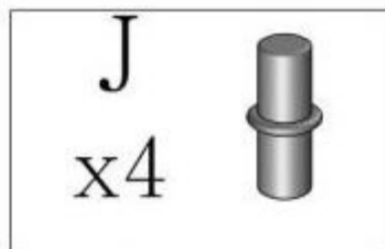
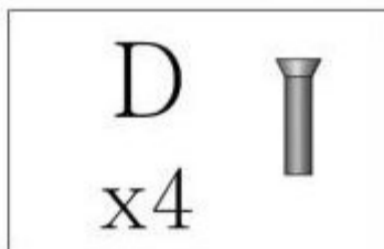
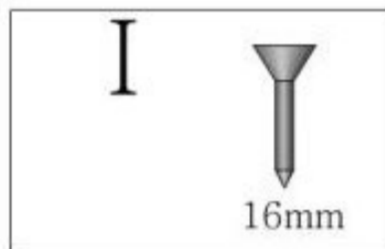
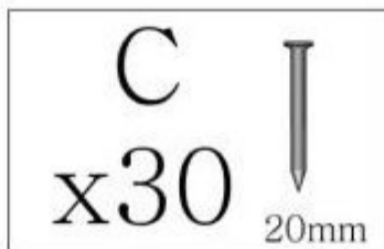
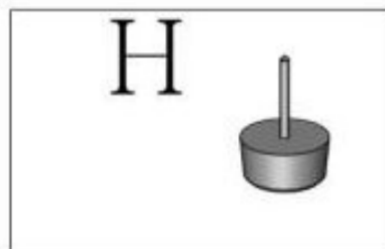
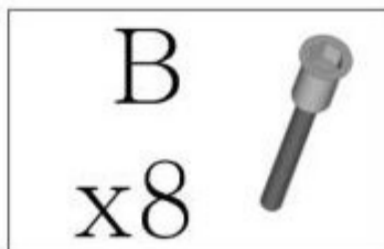
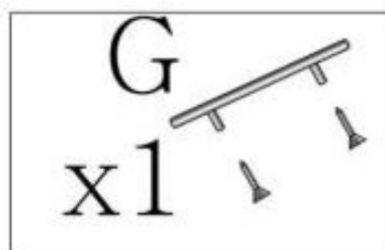
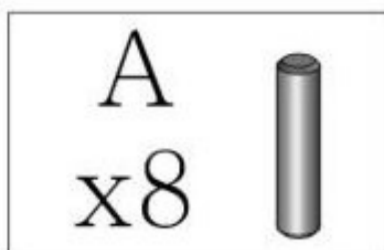

Montážní/Montážny návod		1/1
G40-P_	Je potřebné použiť kladivo a skrutkovač Je třeba použít kladivo a šroubovák	
Promo	Skrinky montujte podľa krokov v montážnom návode Skříňky montujte podle kroků v montážním návodu	
260cm		

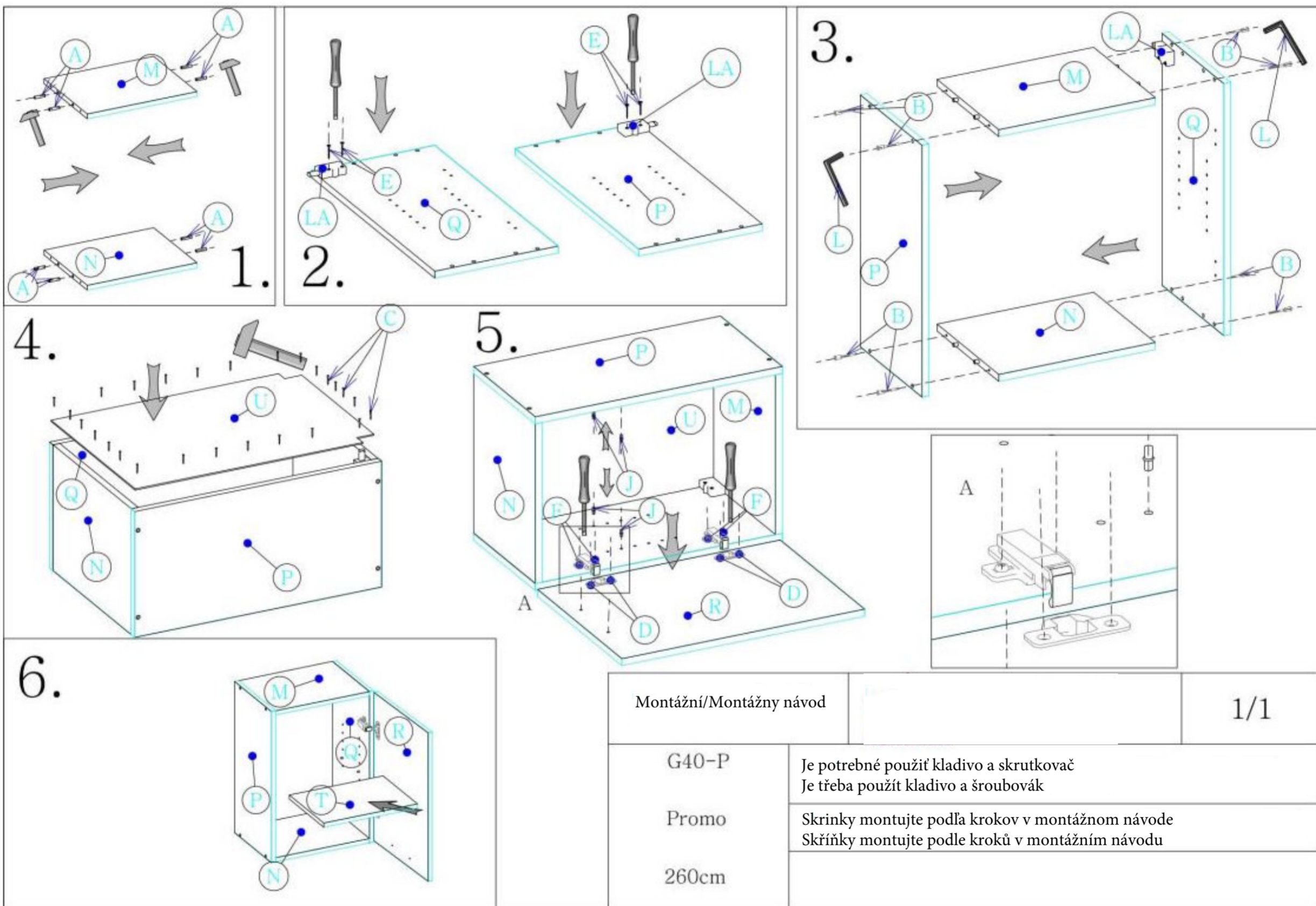

Montážní/Montážny návod		1/1
G40-P	Je potrebné použiť kladivo a skrutkovač Je třeba použít kladivo a šroubovák	
Promo	Skrinky montujte podľa kroků v montážnom návode Skříňky montujte podle kroků v montážním návodu	
260cm		

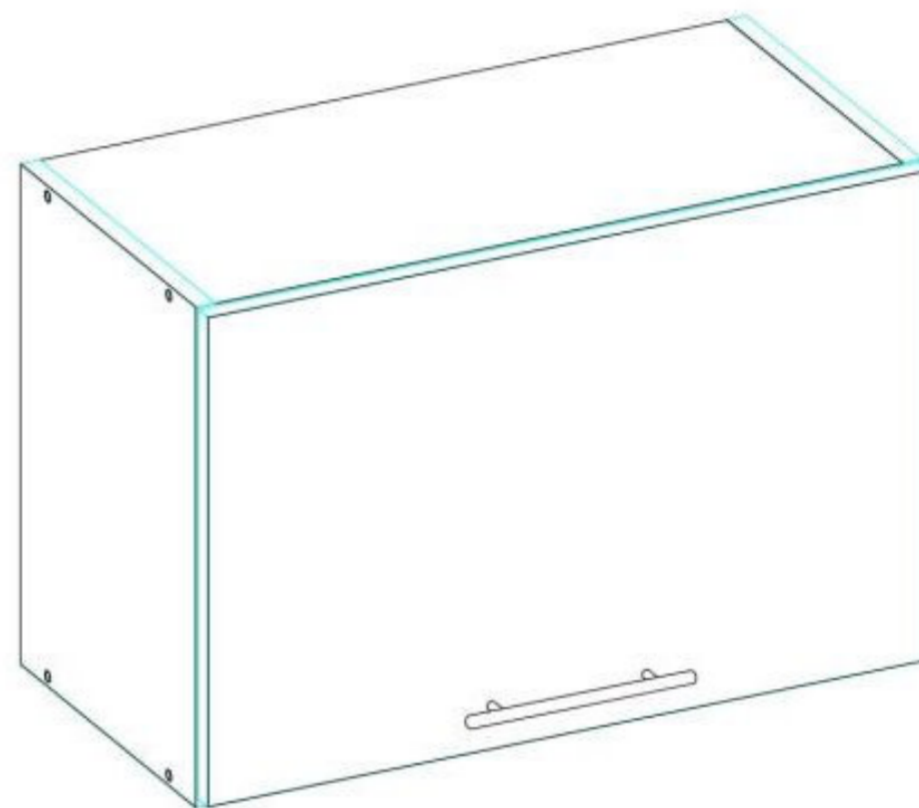
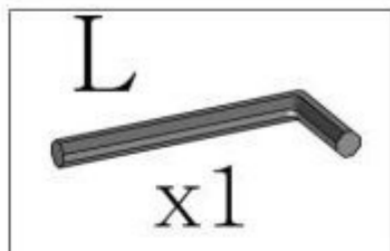
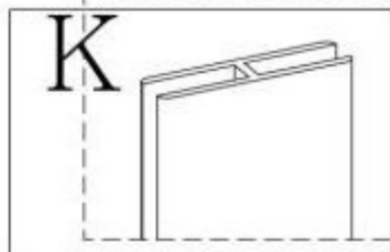
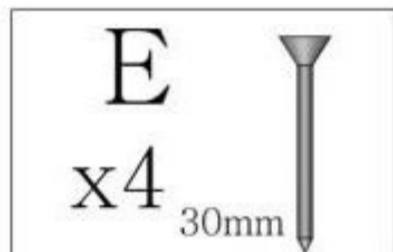
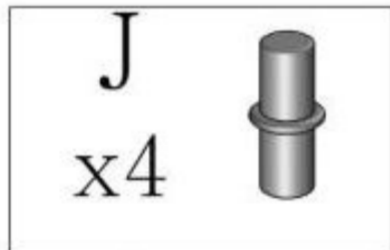
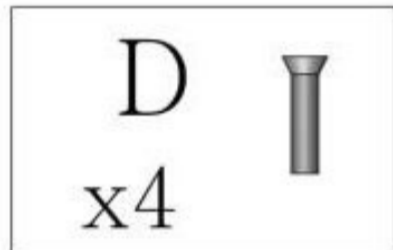
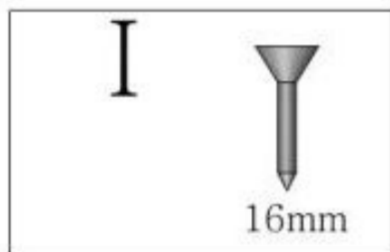
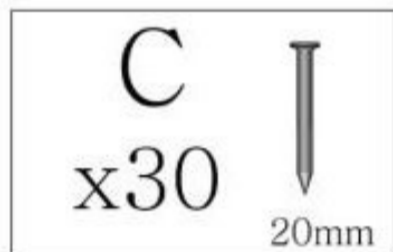
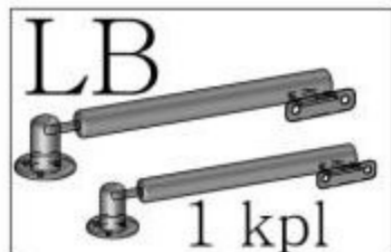
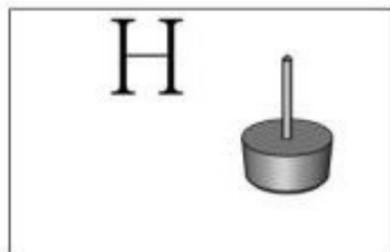
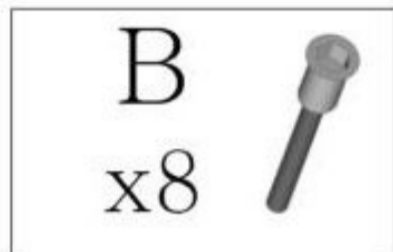
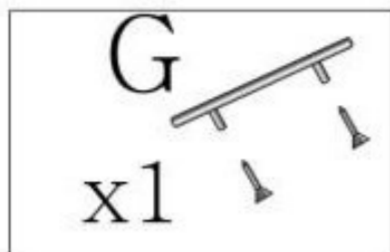
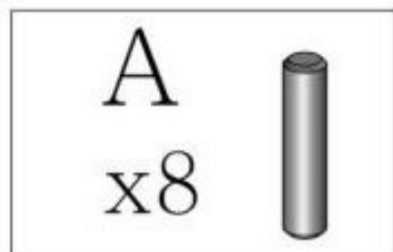

Montážní/Montážny návod		2
G60-OK_	Je potřebné použiť kladivo a skrutkovač Je třeba použiť kladivo a šroubovák	
Promo	Skrinky montujte podľa kroků v montážnom návode Skřínky montujte podle kroků v montážním návodu	
260cm		

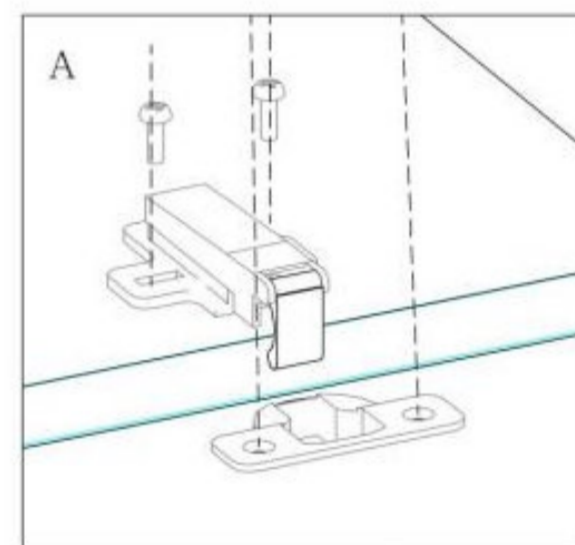
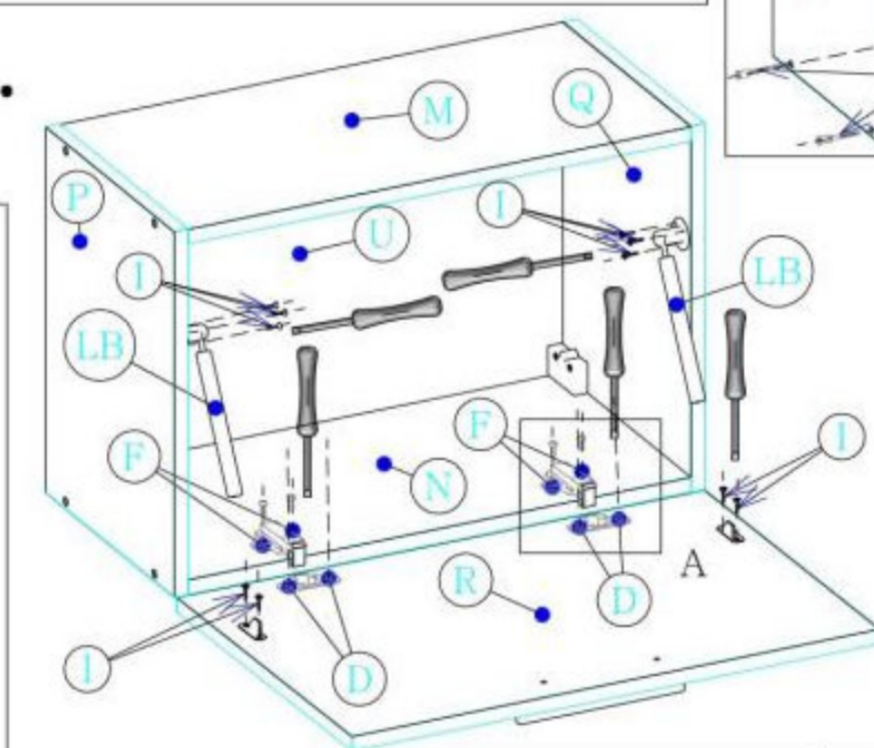
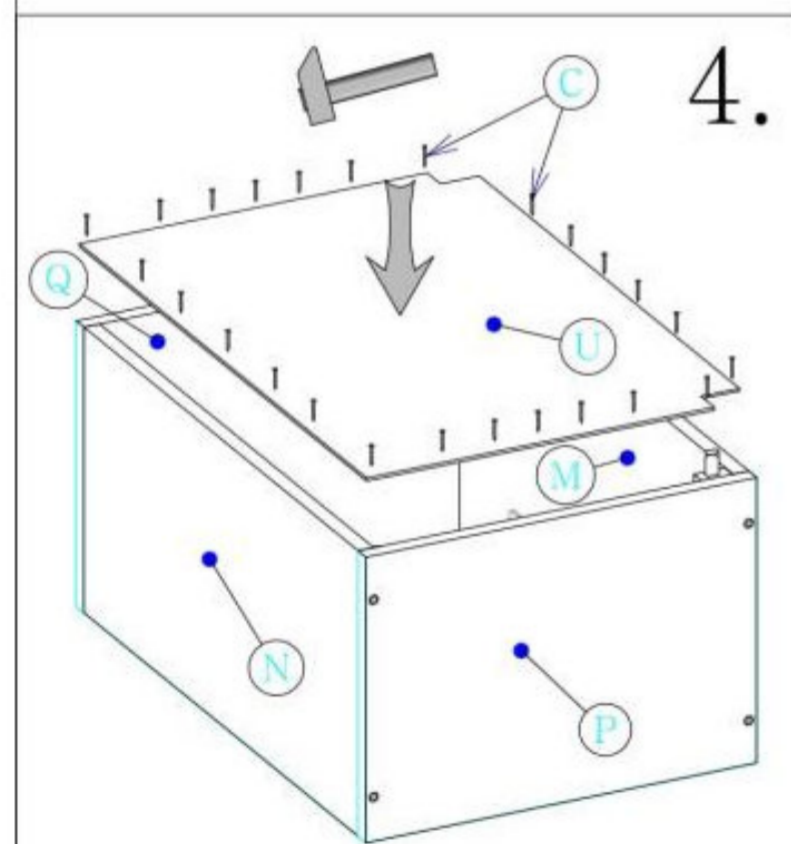
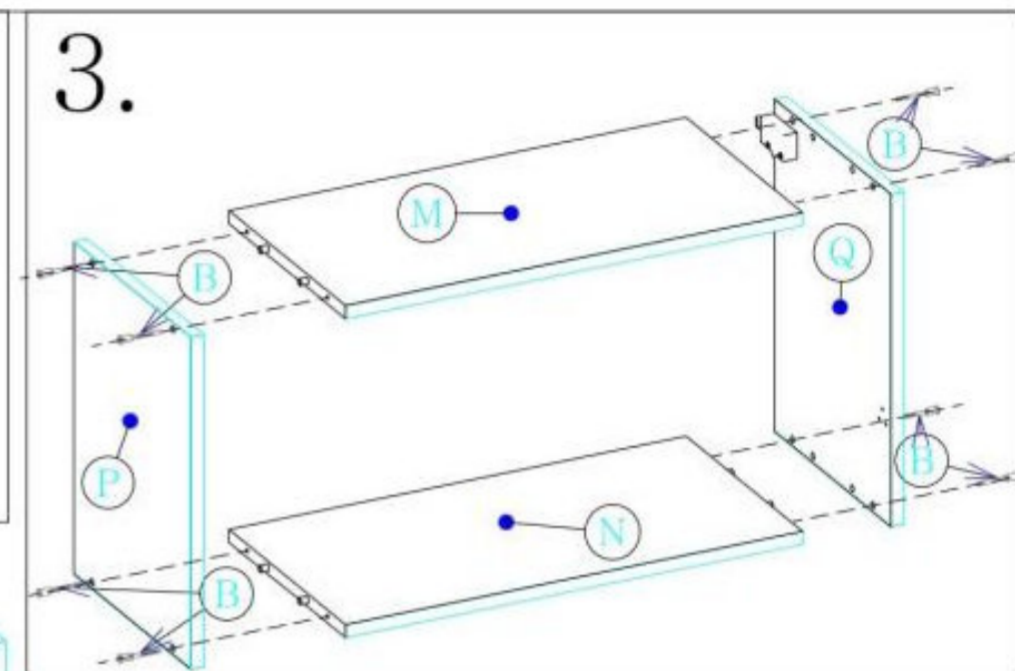
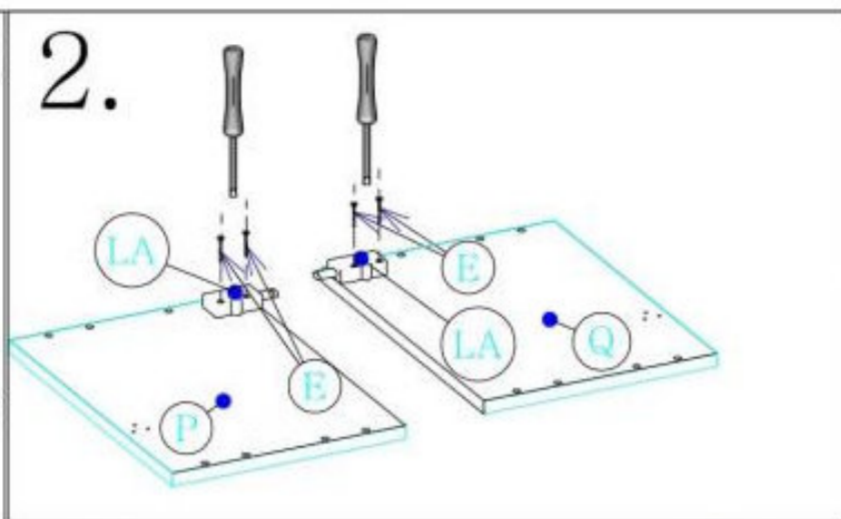
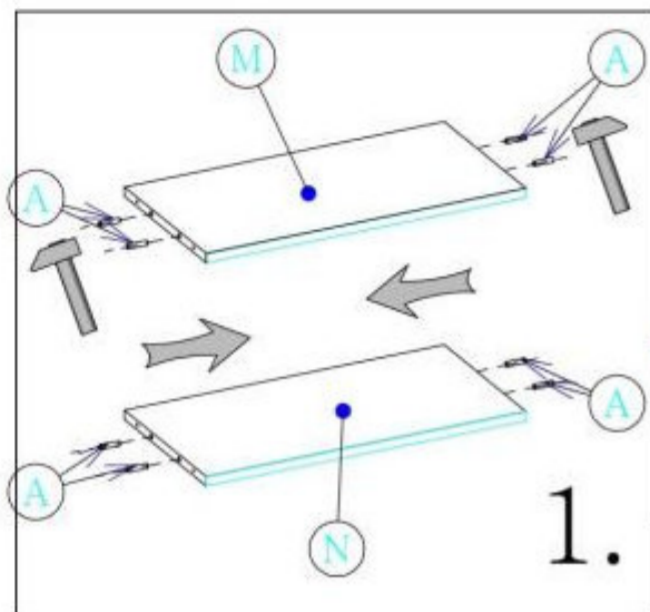

Montážní/Montážny návod

1/1

G60-OK

Je potřebné použít kladivo a skrutkovač
Je třeba použít kladivo a šroubovák

Promo

Skřínky montujte podľa kroků v montážnom návode
Skřínky montujte podle kroků v montážním návodu

260cm

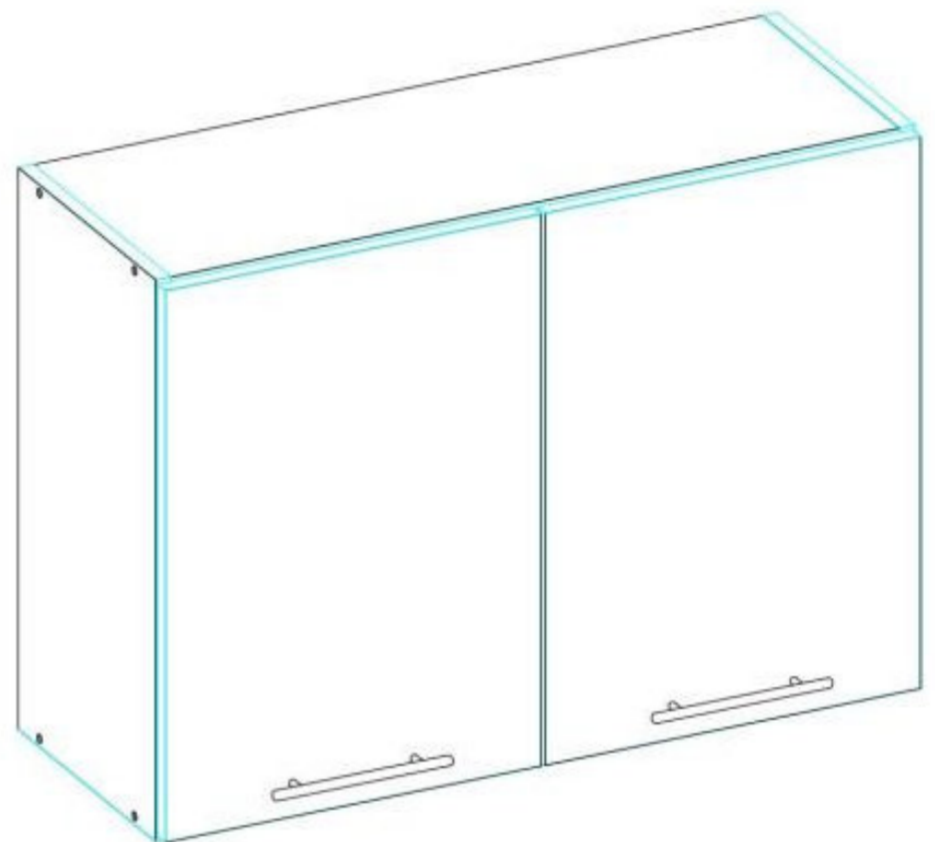
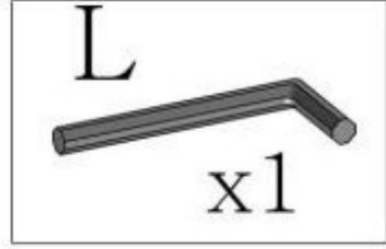
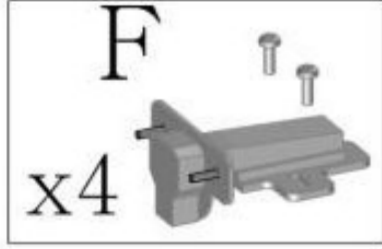
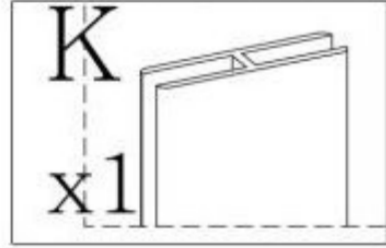
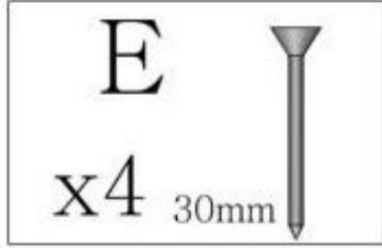
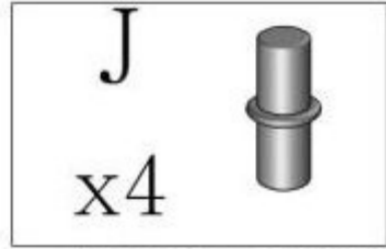
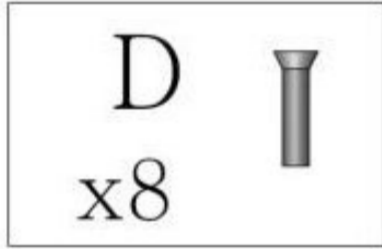
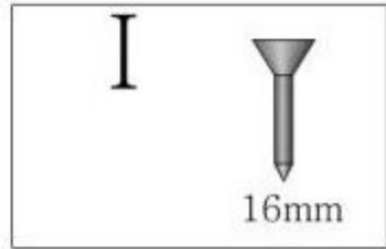
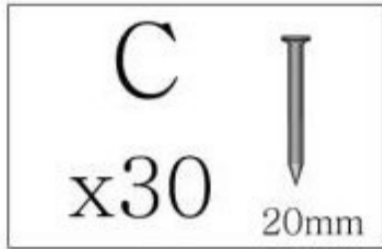
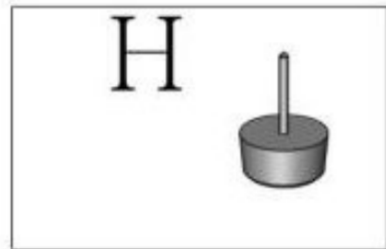
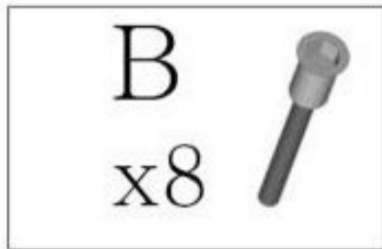
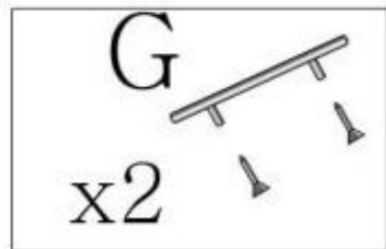
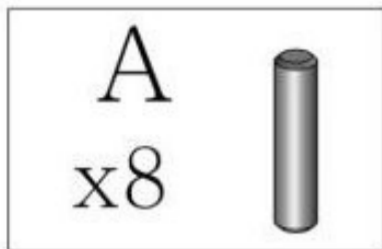

Montážní/Montážny návod		1/1
G80_	Je potřebné použiť kladivo a skrutkovač Je třeba použiť kladivo a šroubovák	
Promo	Skřínky montujte podľa kroků v montážnom návode Skřínky montujte podle kroků v montážním návode	
260cm		

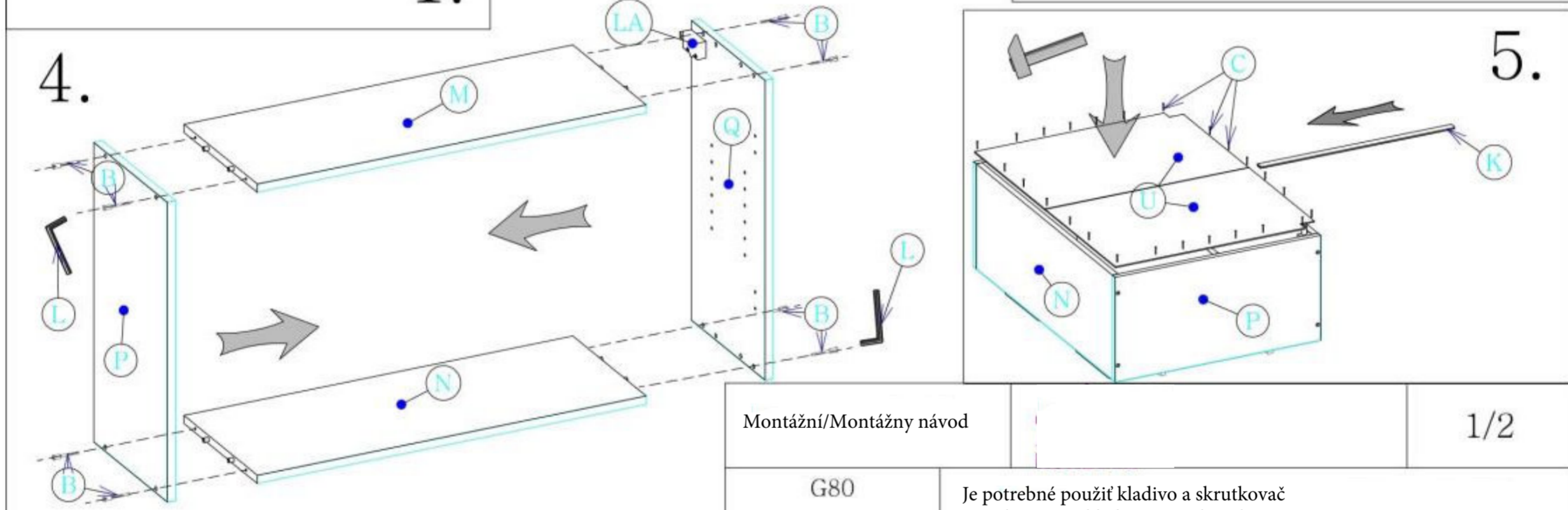
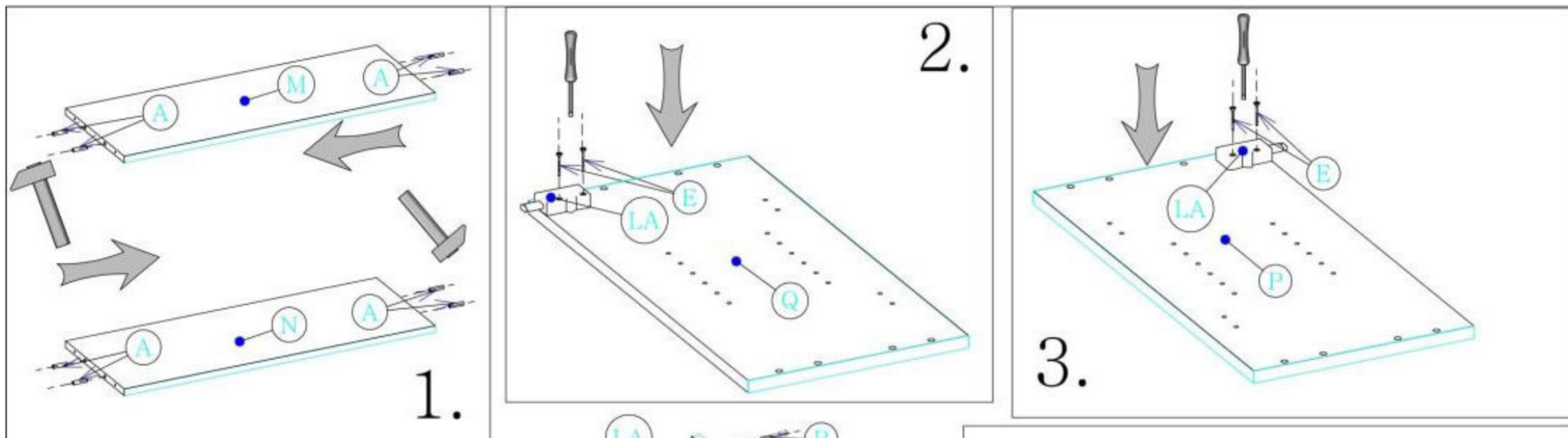

Montážní/Montážny návod		1/2
G80	Je potrebné použiť kladivo a skrutkovač Je třeba použít kladivo a šroubovák	
Promo	Skrinky montujte podľa kroků v montážnom návode Skříňky montujte podle kroků v montážním návodu	
260cm		

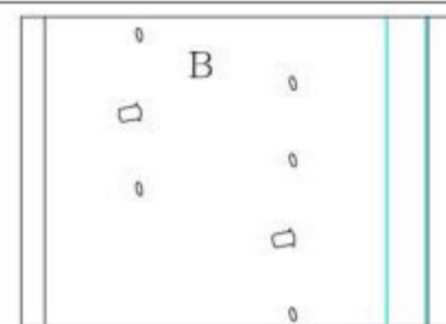
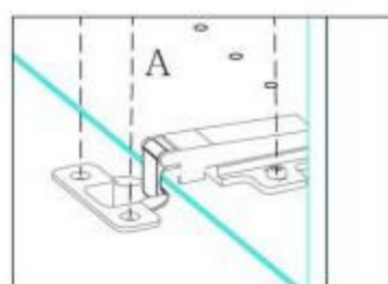
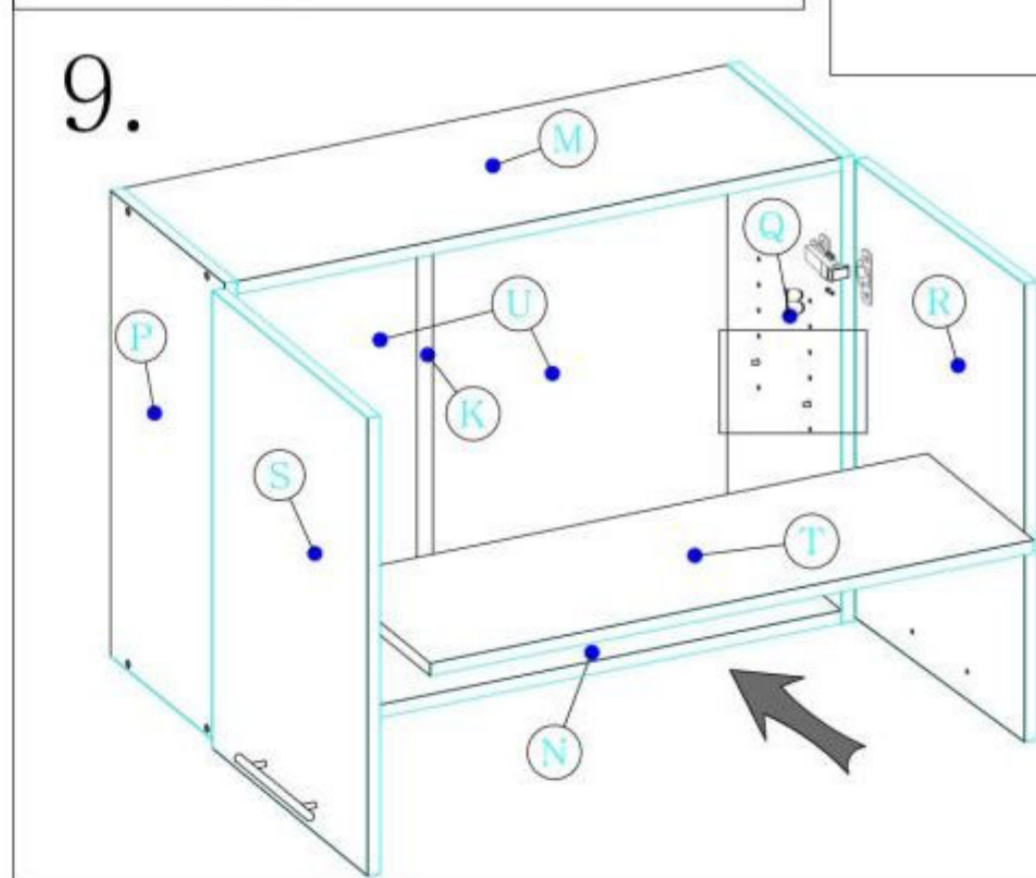
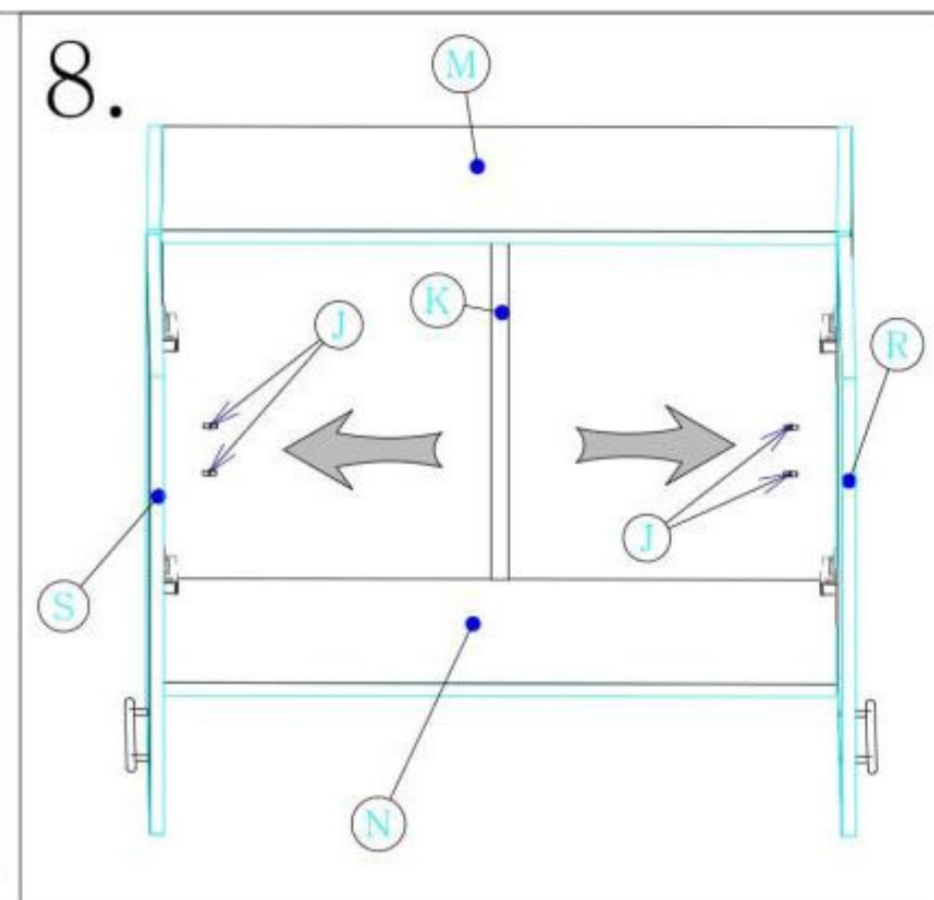
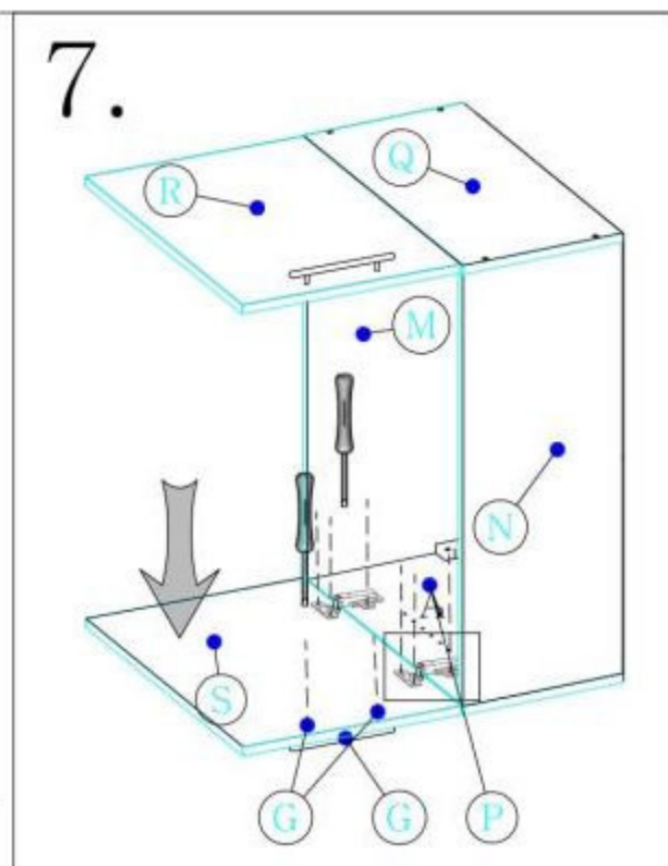
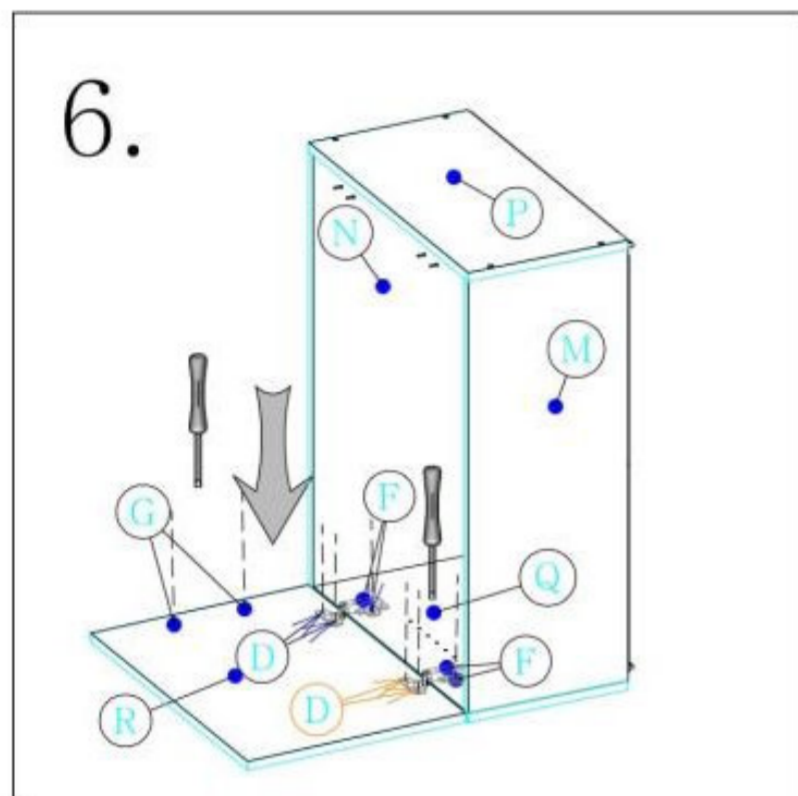

Montážní/Montážny návod		2/2
G80	Je potřebné použít kladivo a šroukovač Je třeba použít kladivo a šroubovák	
Promo	Skřínky montujte podľa kroků v montážním návode Skřínky montujte podľa kroků v montážním návode	
260cm		

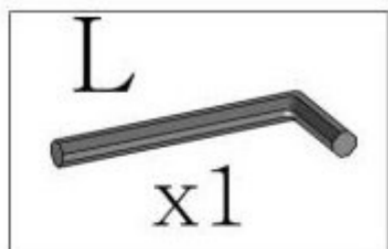
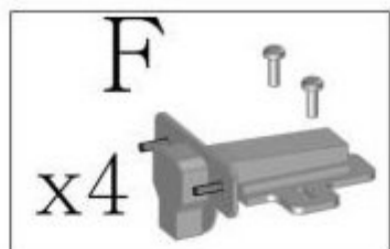
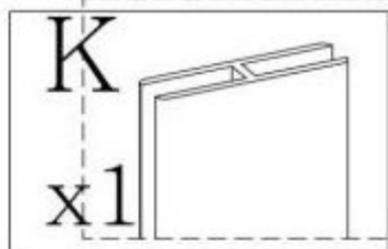
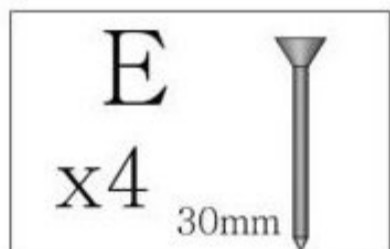
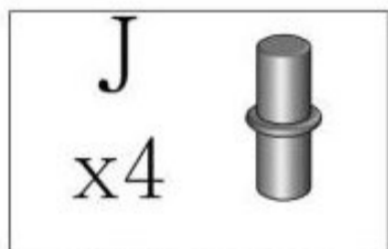
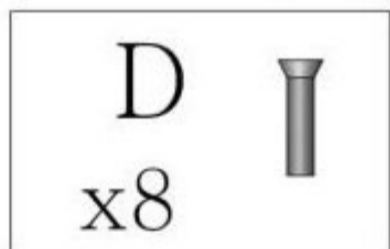
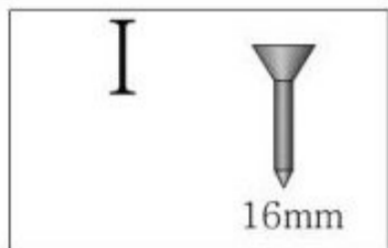
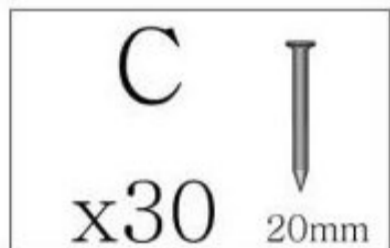
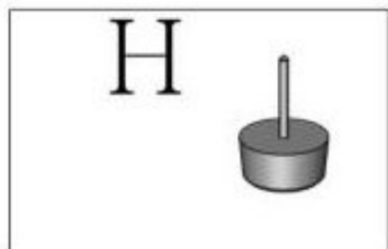
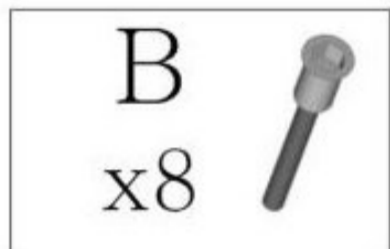
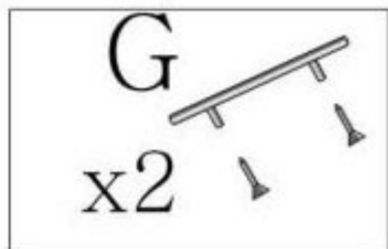
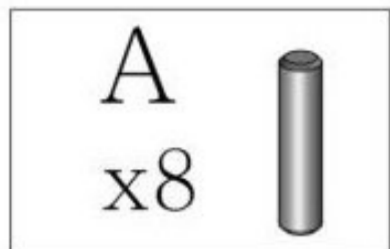

Montážní/Montážny návod		3
G80W_	Je potřebné použít kladivo a šroukovač Je třeba použít kladivo a šroubovák	
Promo	Skrinky montujte podľa kroků v montážnom návode Skříňky montujte podle kroků v montážním návodu	
260cm		

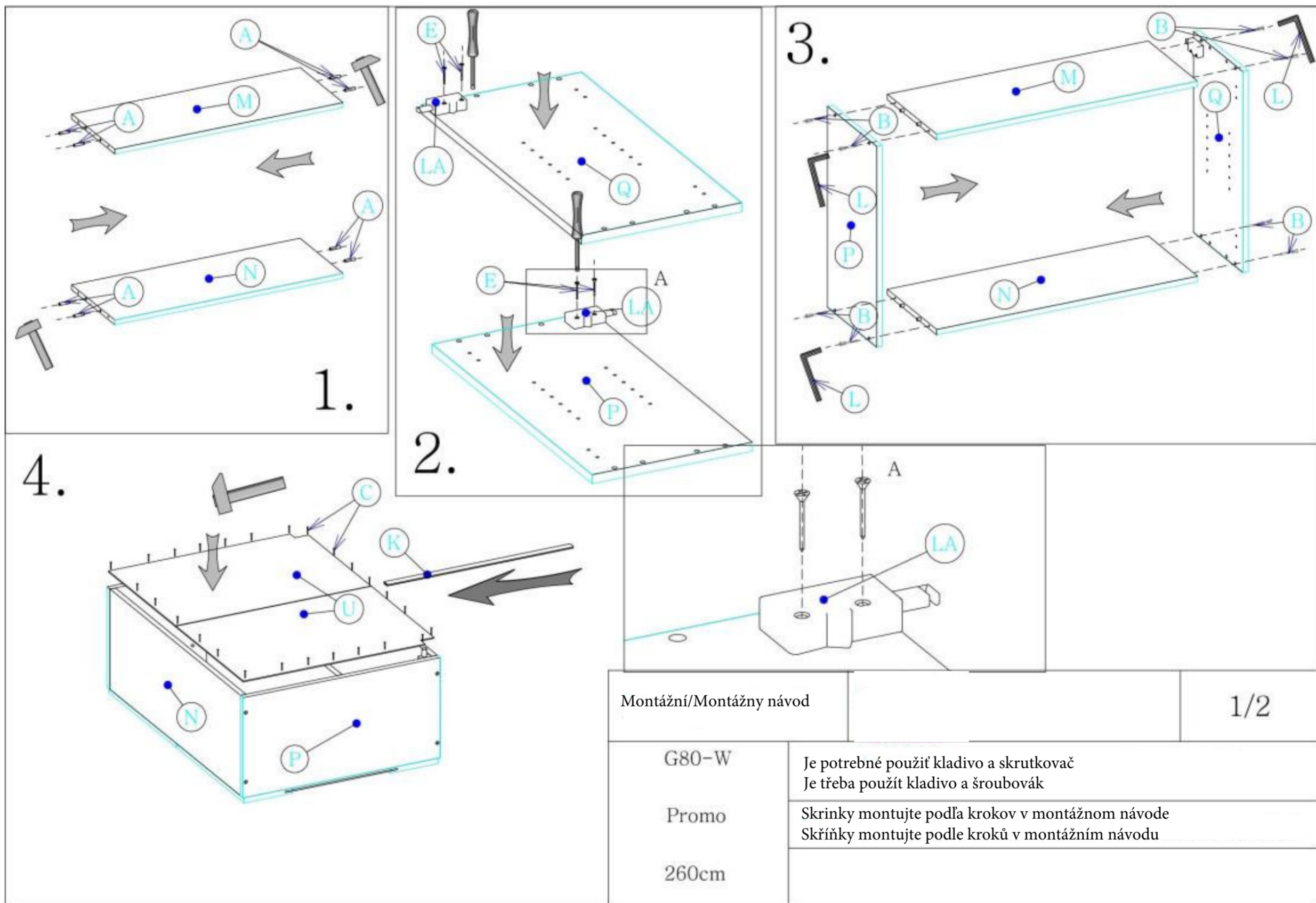

5.

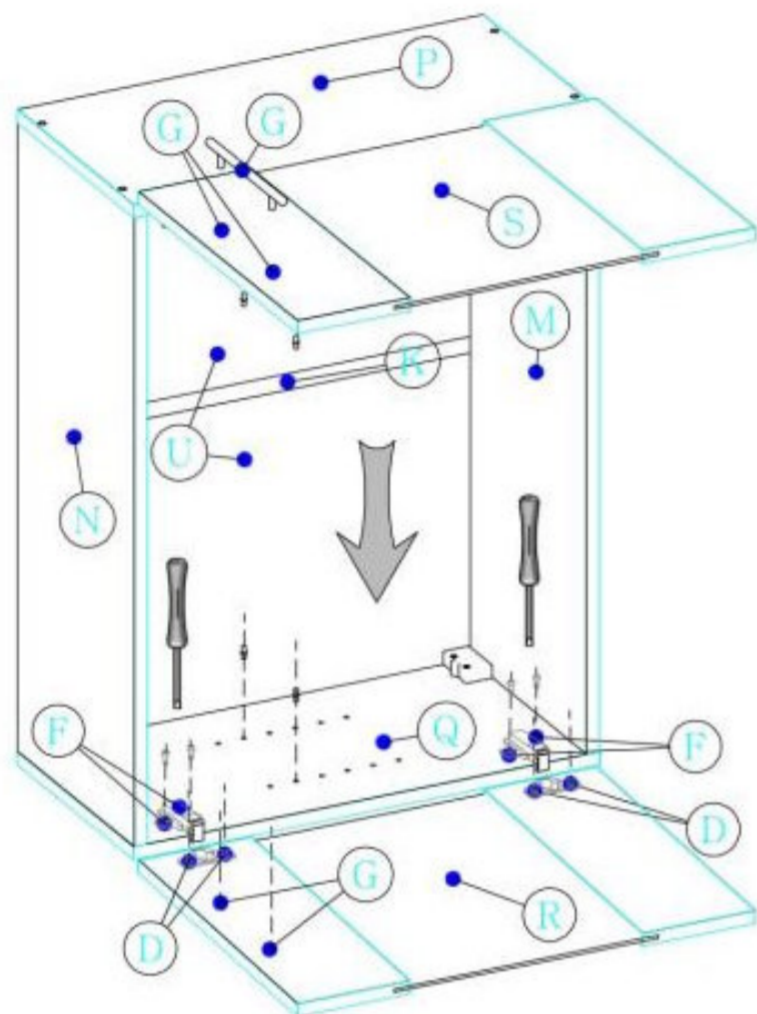

6.

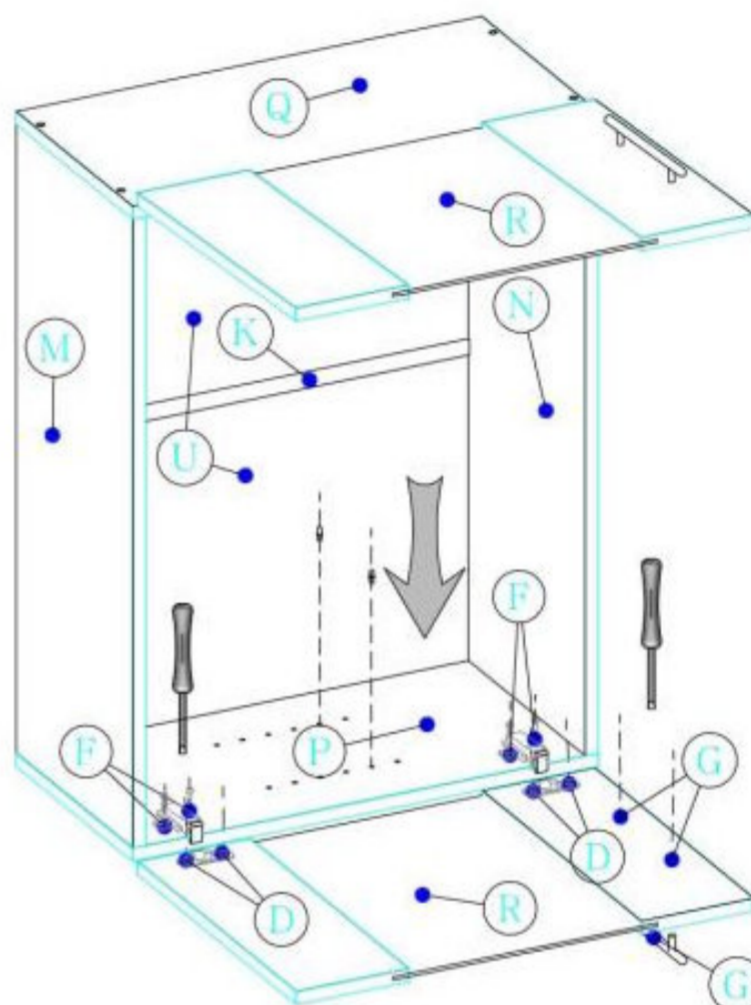

7.

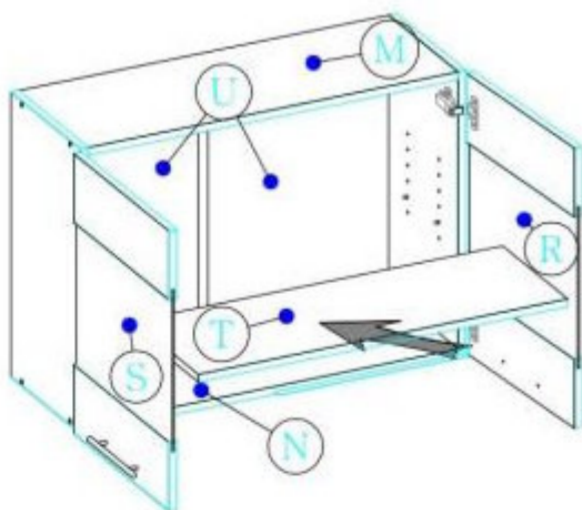

Montážní/Montážny návod

2/2

G80-W

Je potřebné použít kladivo a skrutkovač
Je třeba použít kladivo a šroubovák

Promo

Skrinky montujte podľa kroků v montážnom návode
Skříňky montujte podle kroků v montážním návodu

260 cm