

Shirin

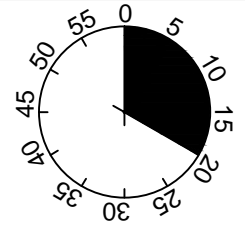

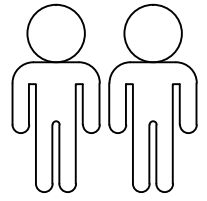
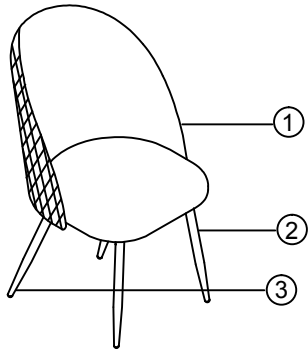

1

2

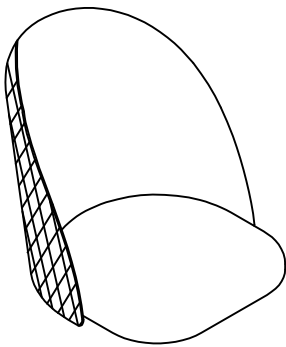
3





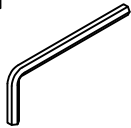

1	1X
2	2X
3	2X

<p>A M6x30</p>  <p>12x</p>	<p>B Ø18xØ6x1.5</p>  <p>12x</p>	<p>C 5MM</p>  <p>1x</p>
--	---	---

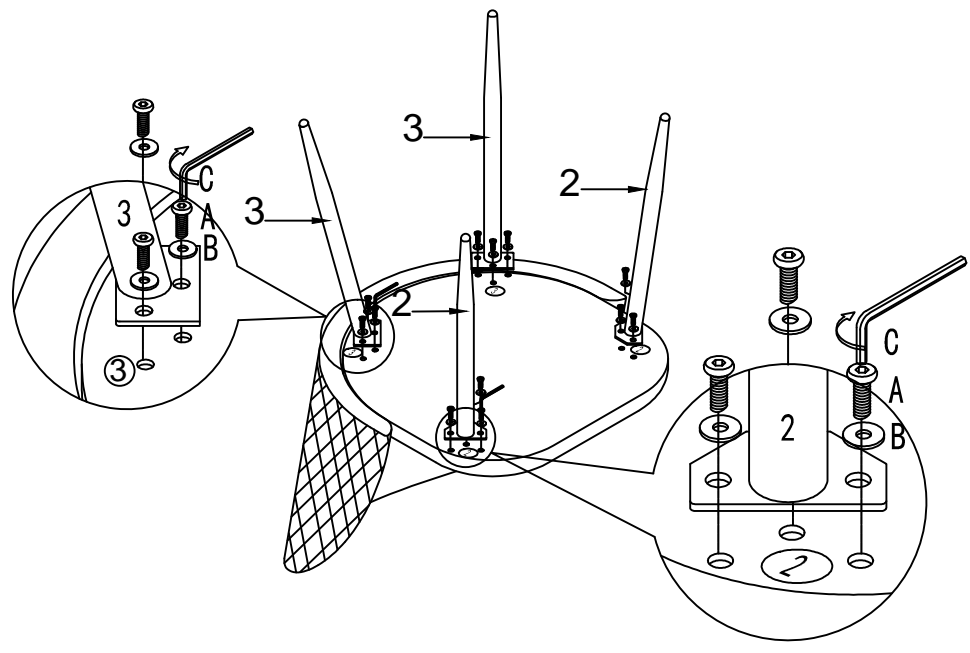
I.

1



- A M6x30

12x
- B Ø18xØ6x1.5

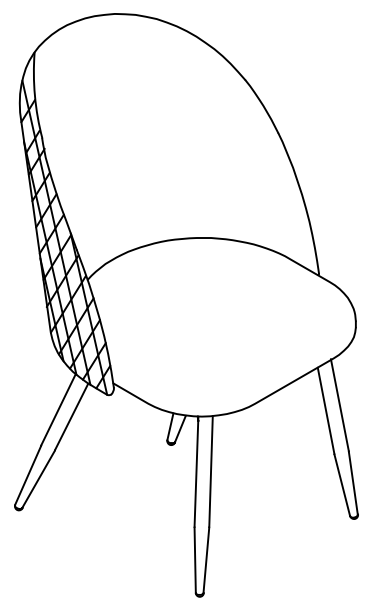
12x
- C 5MM

1x
- 

2



- C 5MM

1x
- 