

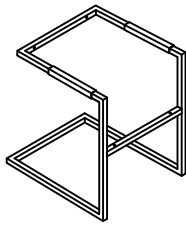

LINDA Armlehnen stuhl: 62-370-94-A

1 PERSON

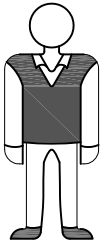

Ⓐ X1

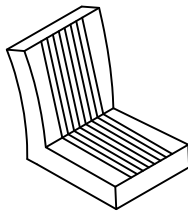

Ⓑ X1

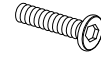

M6*45mm

Ⓒ X2



M6*40mm

Ⓓ X2

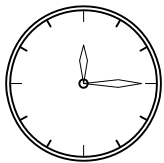

15min



Ø16*6mm

Ⓔ X4

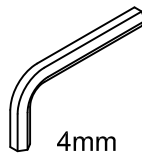

4mm

Ⓕ X1

1

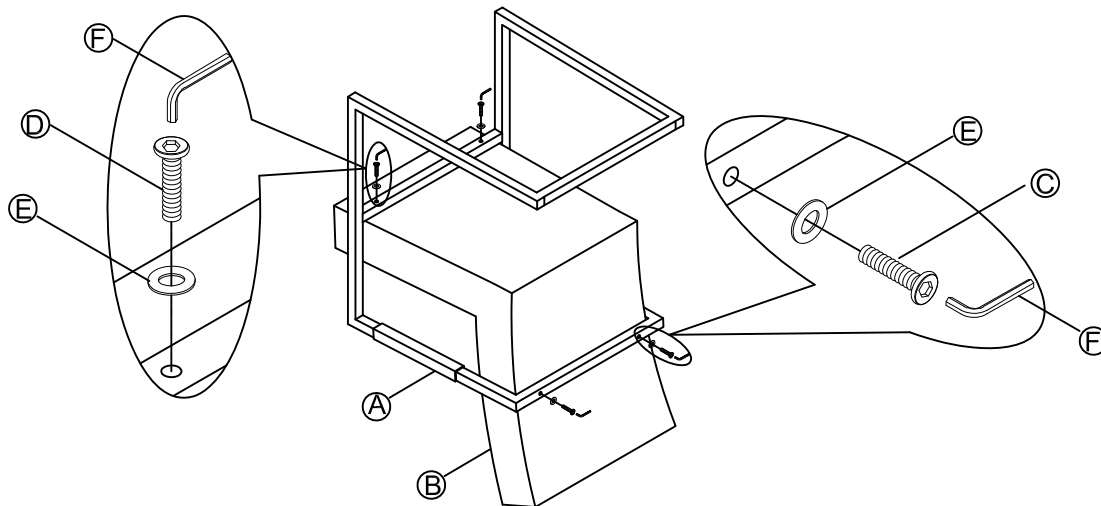

2

