

# MONTANA

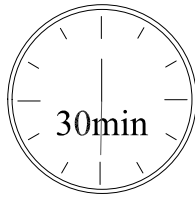

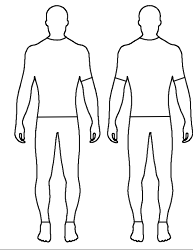

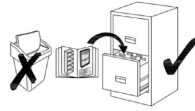
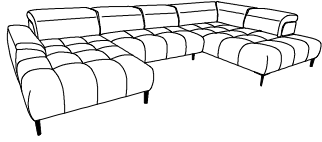
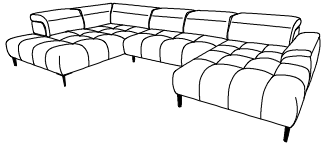
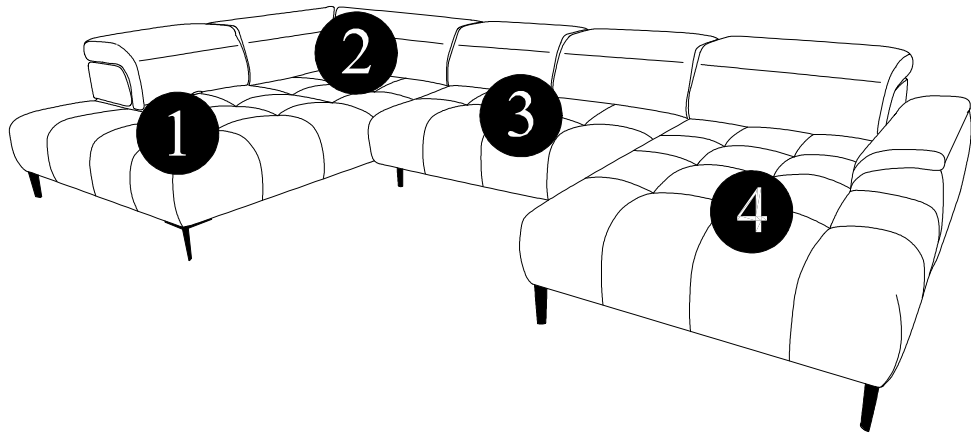

## L

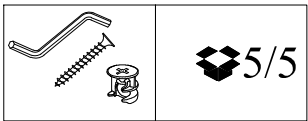
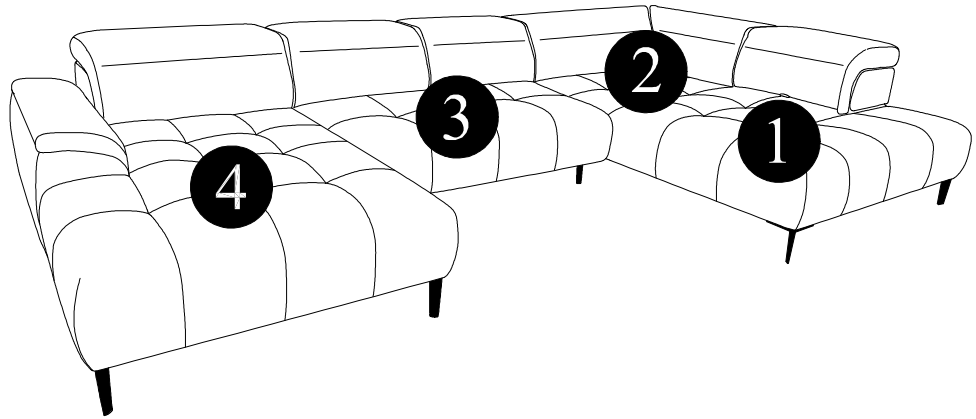

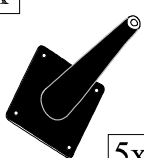
## R

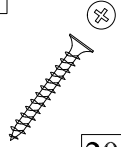
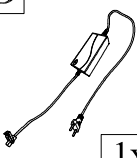

<p>A</p>  <p>5x</p>	<p>B</p>  <p>10x</p>	<p>C</p>  <p>20x</p>	<p>D</p>  <p>1x</p>	<p>E</p>  <p>10x</p>
<p>H-155</p>	<p>H-150</p>	<p>5x30</p>		

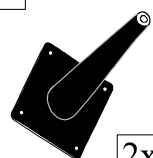
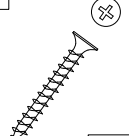
 <p>A</p> <p>2x</p>	 <p>C</p> <p>8x</p>
<p>H-155</p>	<p>5x30</p>

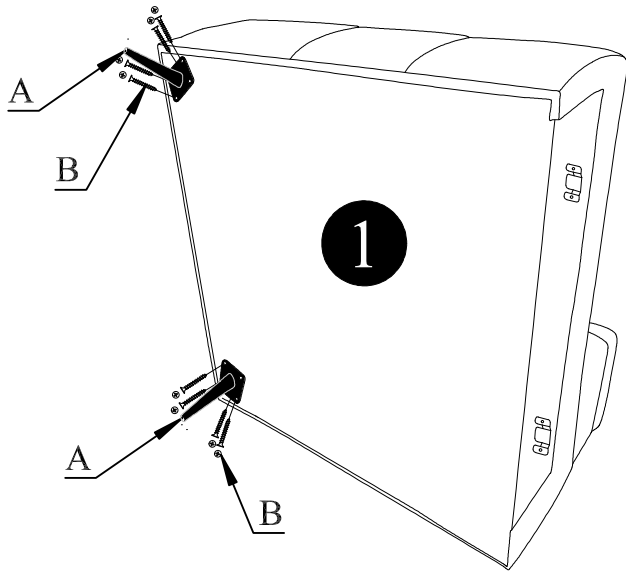

1

L



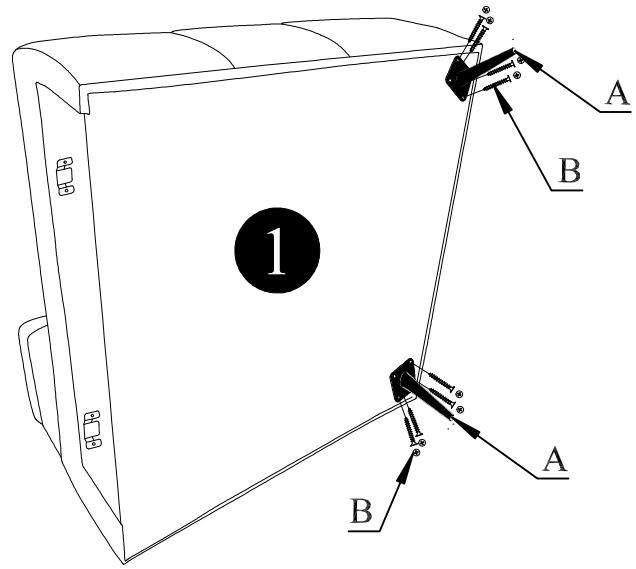

R

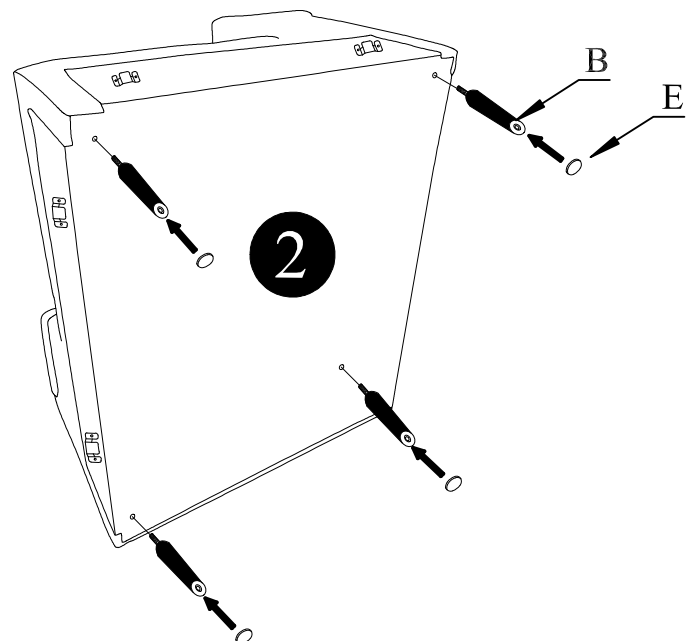
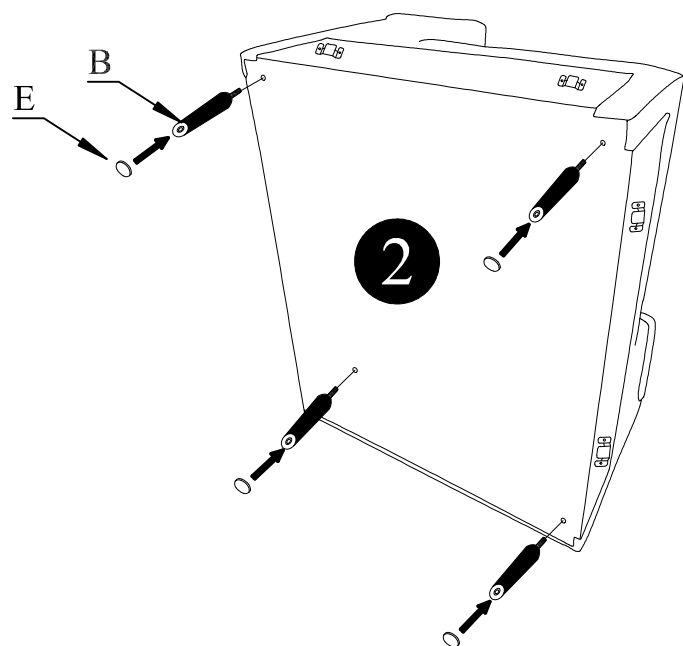

 <p>B</p> <p>4x</p>	 <p>E</p> <p>4x</p>
<p>H-150</p>	

2



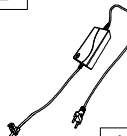
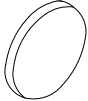

B	D	E
		
4x	1x	4x
H-150		

3

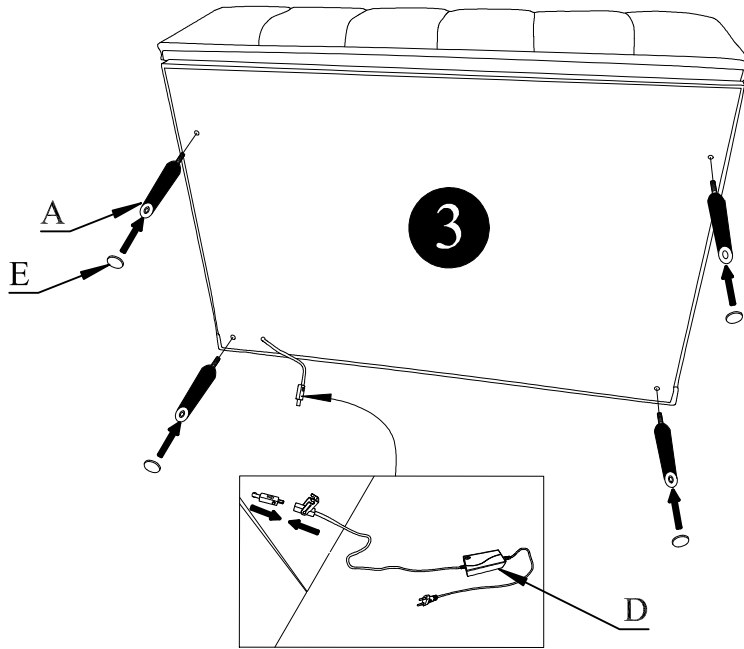
LR

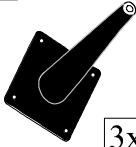

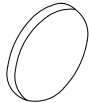
A	B	C	E
			
3x	2x	12x	2x
H-155	H-150	5x30	

4

R

L

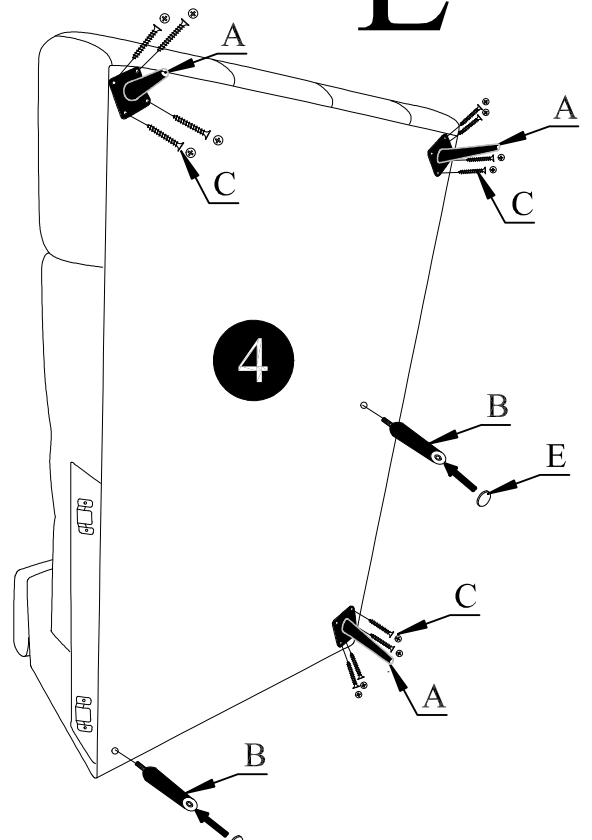
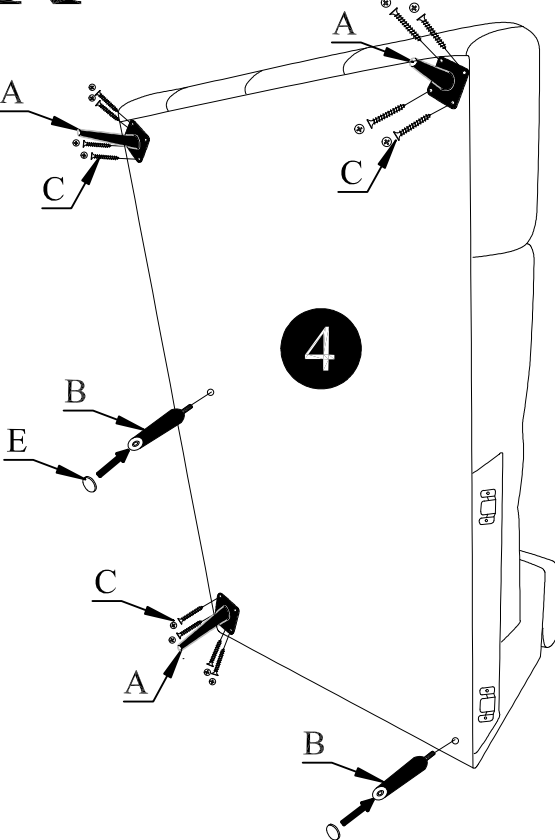

5

