

180 min

A	B	C1	C2	C3	D
1	L126-0050	2044	496	22	515
2	L126-0051	2044	496	22	515
3	L126-1050	2140	585	15	315
4	L126-1051	2140	585	15	315
5	L126-1052	2050	585	18	415
6	L126-3054	1019	565	22	115
7	L126-3058	1019	585	15	215
8	L126-3059	519	585	15	215
9	L126-3060	1556	585	15	215
10	L126-3061	519	565	22	115
11	L126-3062	518	560	22	115
12	L126-4002	1604	90	25	215
13	L126-4053	510	100	16	215
14	L126-4057	1556	75	15	215
15	L126-4058	1588	100	16	215
16	L126-5053	585	90	8	215
17	L126-5054	2050	43	19	415
18	L126-5055	636	67	22	215
19	L126-5057	636	67	22	215
20	L126-5065	1640	67	22	215
21	L126-9052	2044	529	2,5	415
22	L126-9351	2044	1029	2,5	415
23	dr-1014	1014	30	15	215

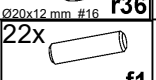

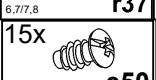

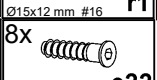
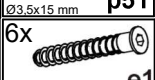
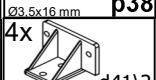
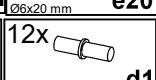
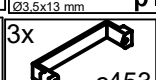
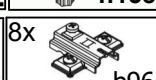
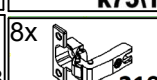
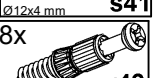
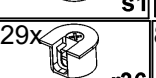
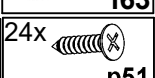
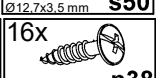
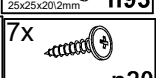
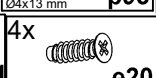
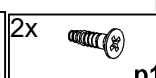
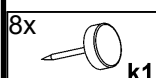
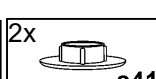
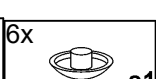
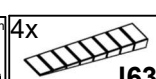
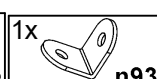
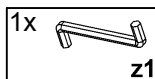
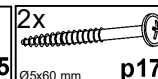
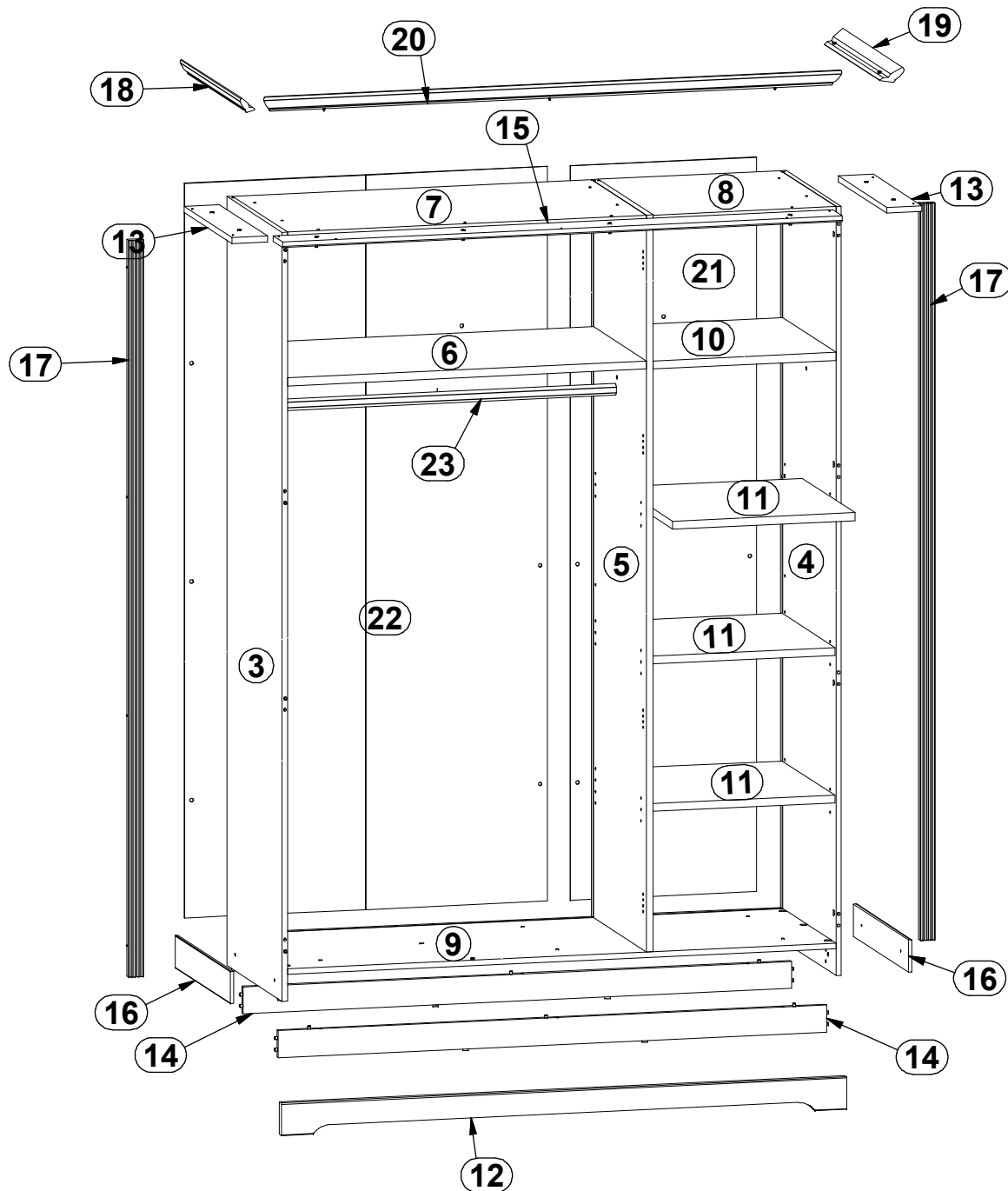
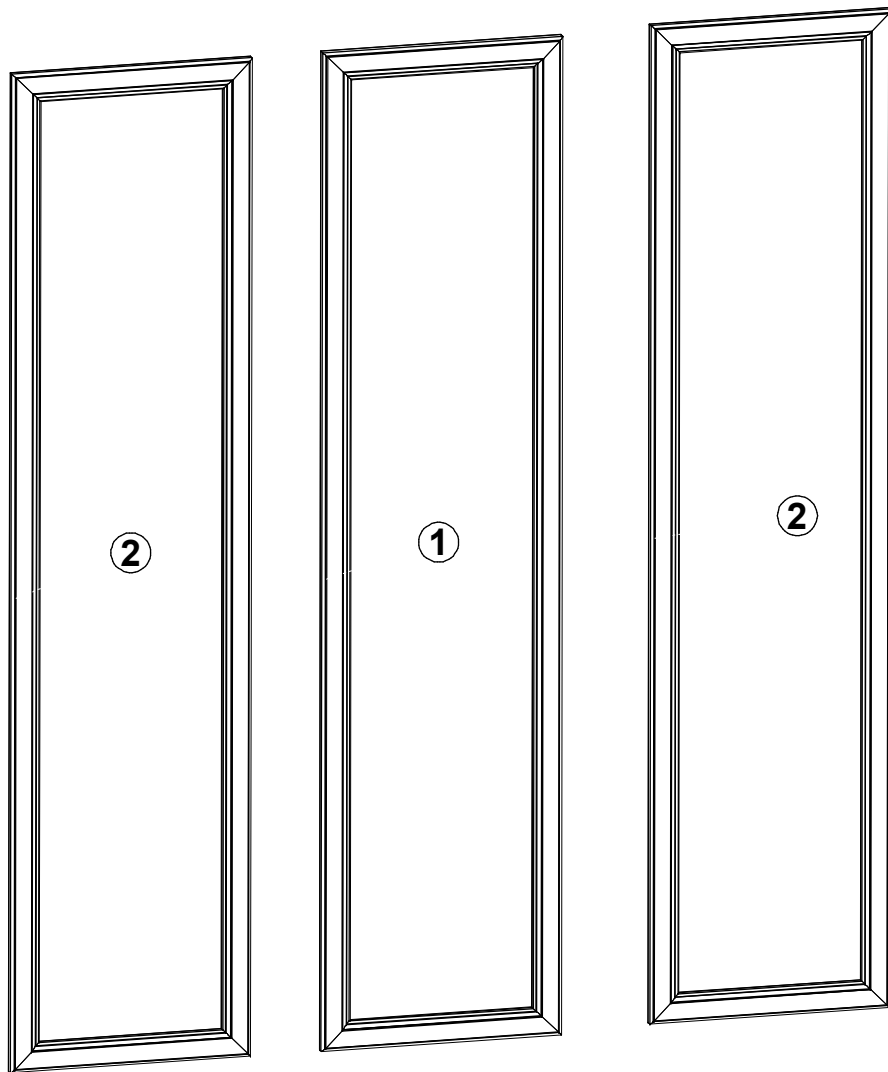

1

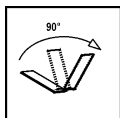
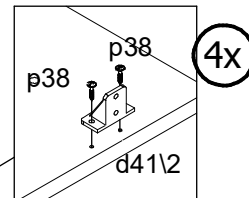
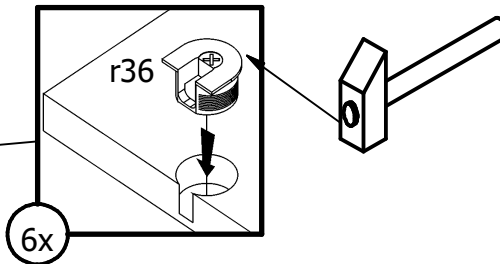

9

9

9

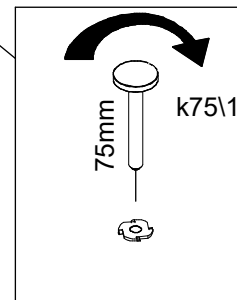
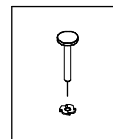
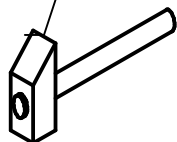
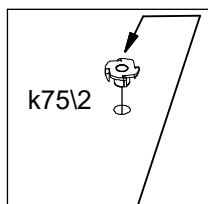

2x

2

2x

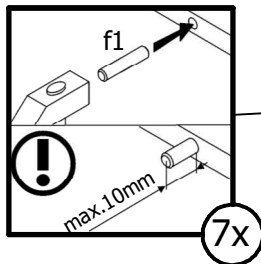

14

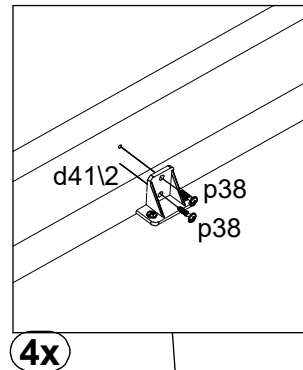
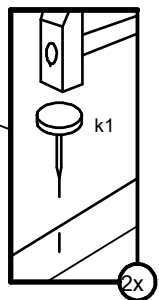
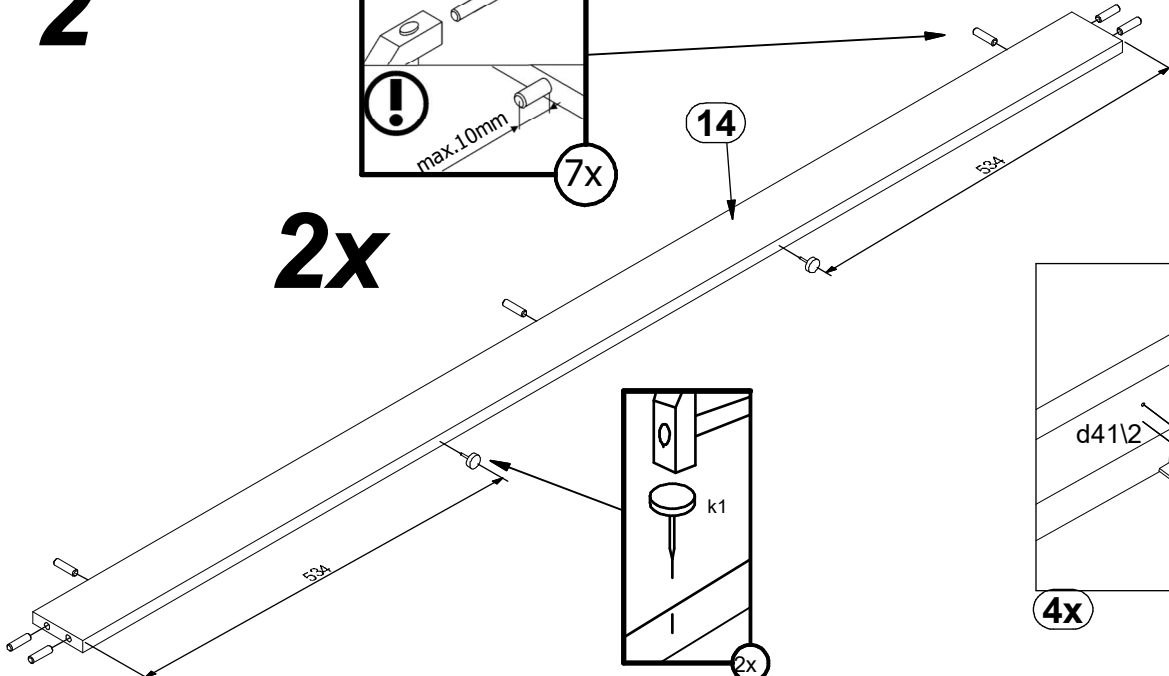

12

3

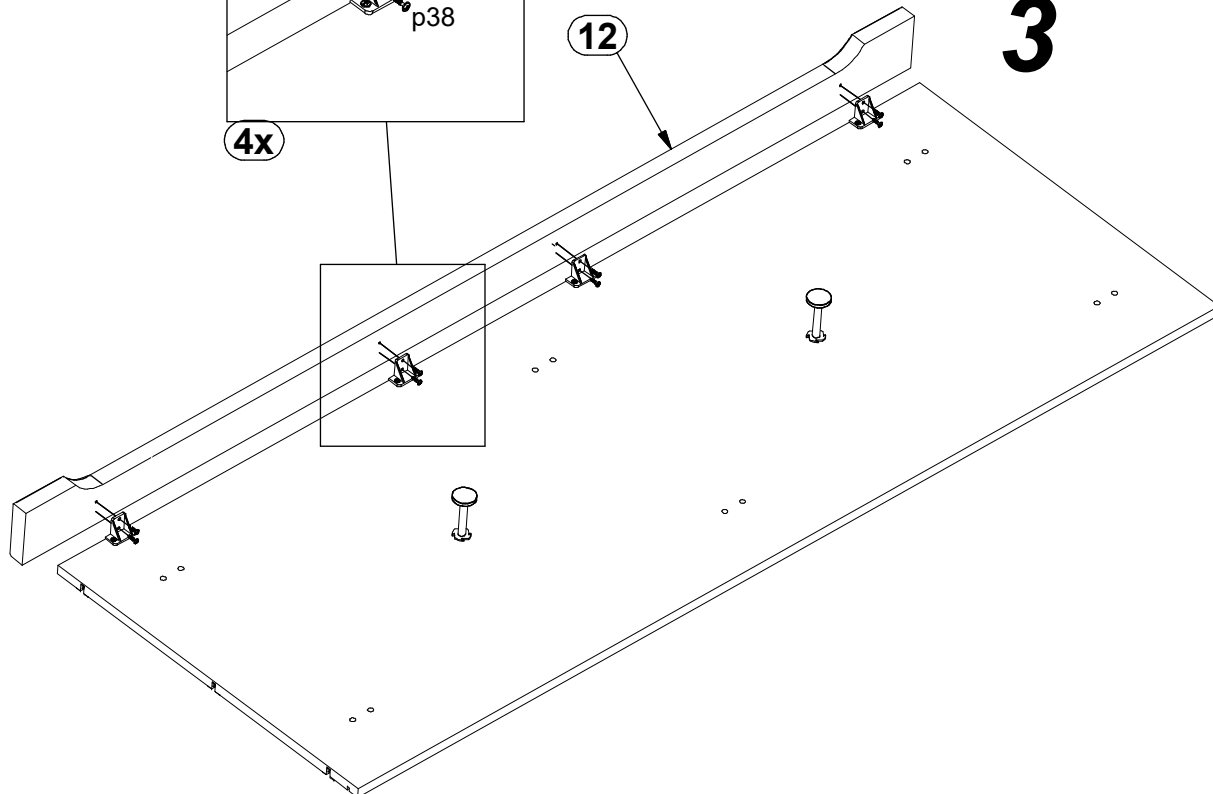

4

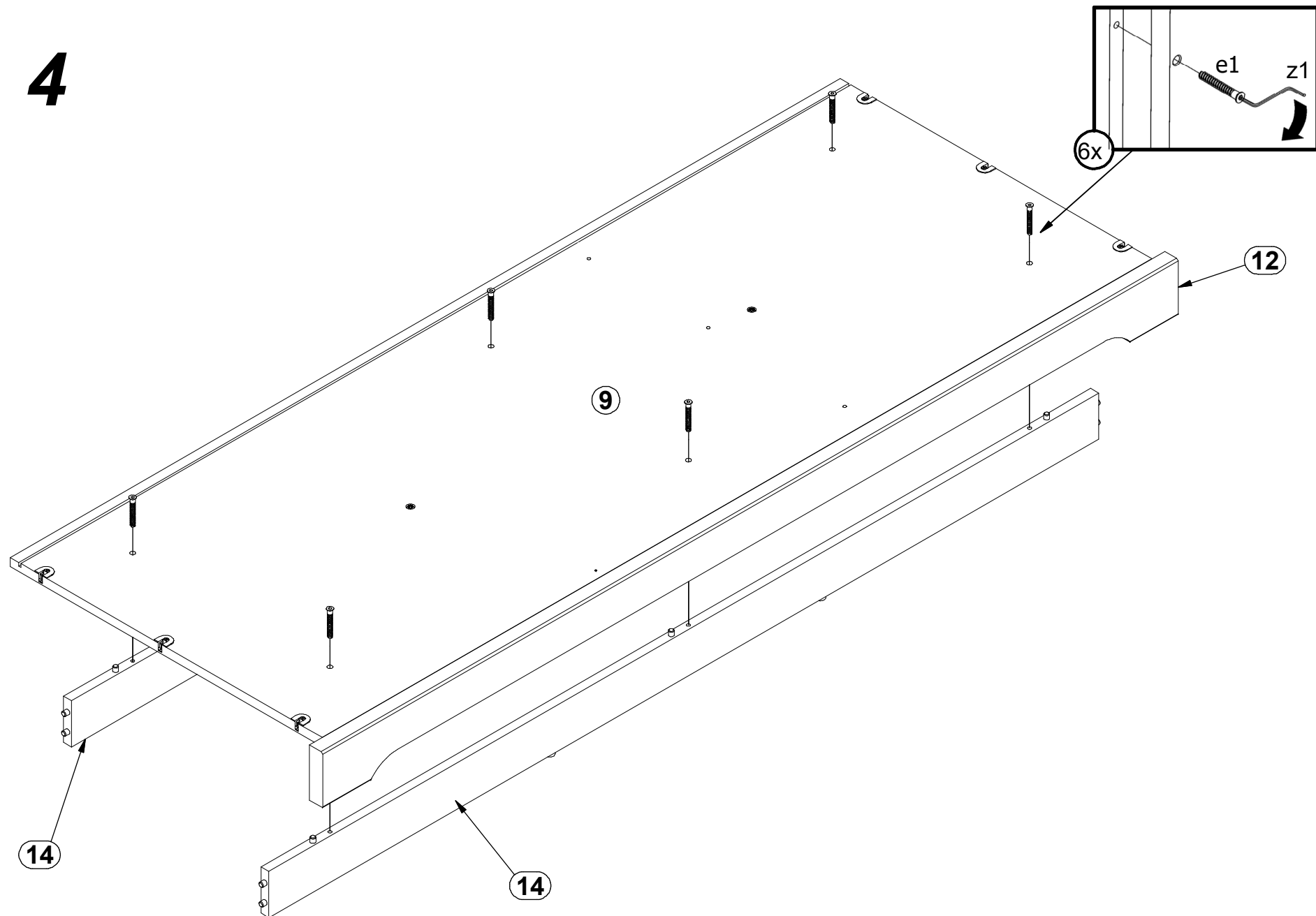

5

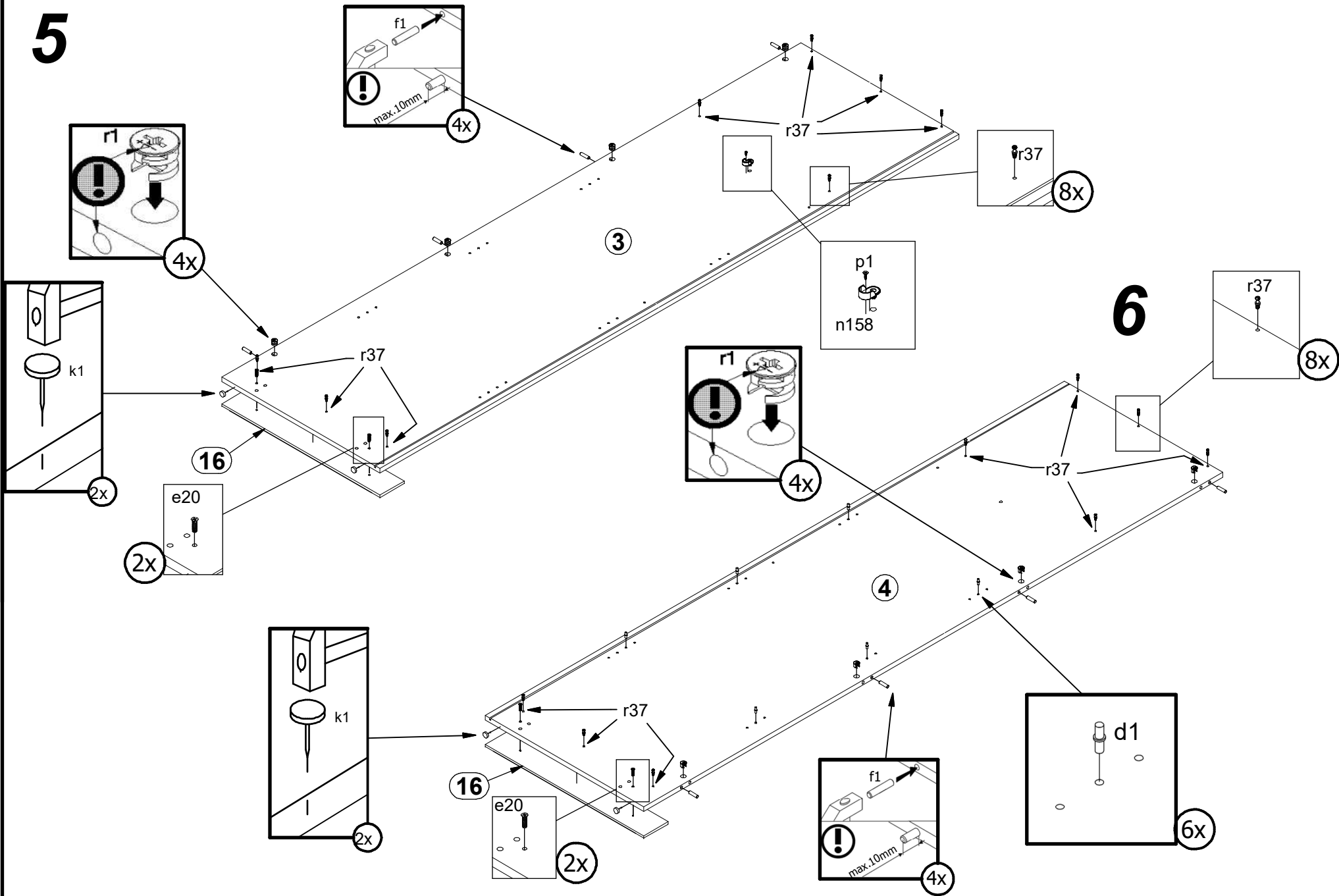

7

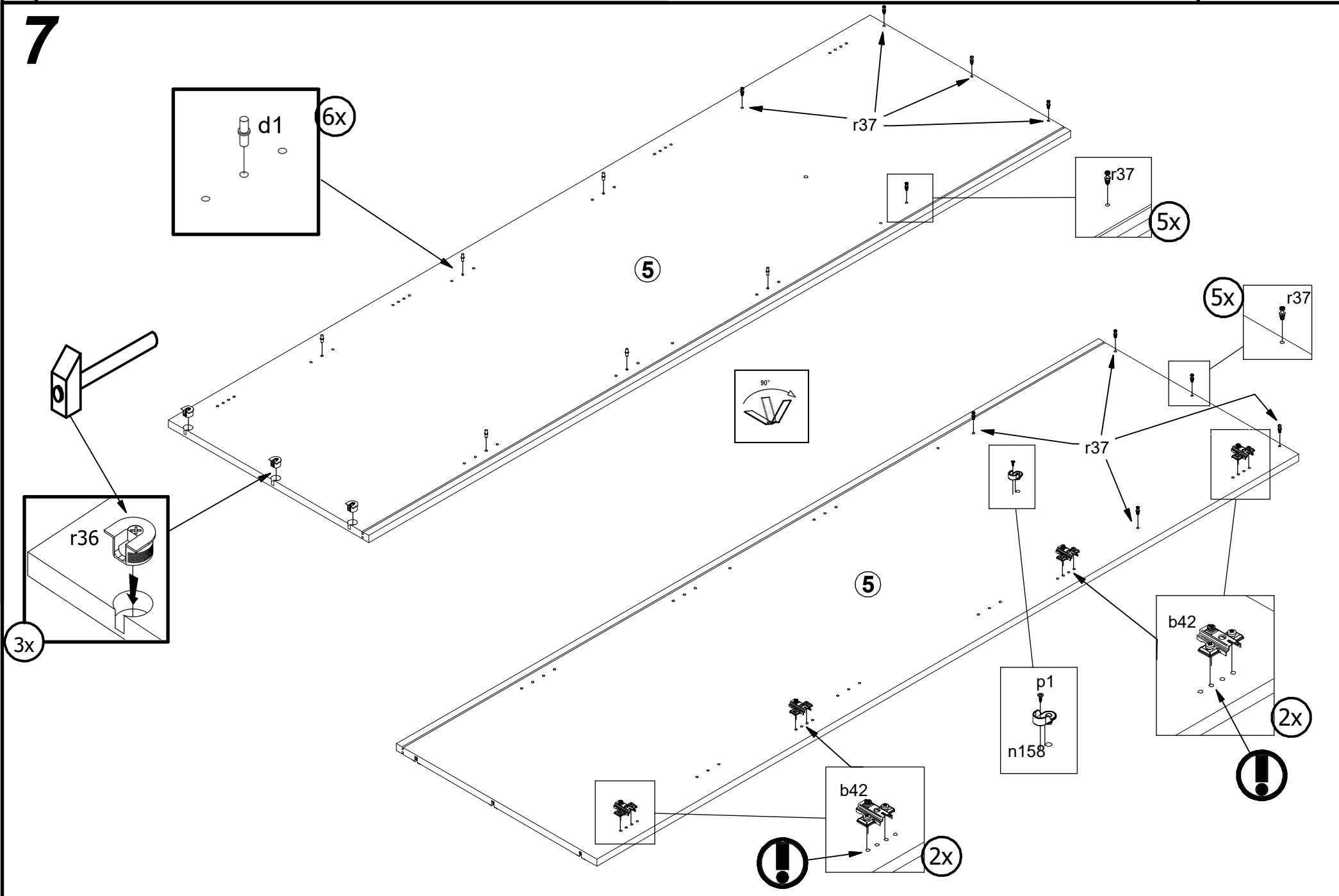

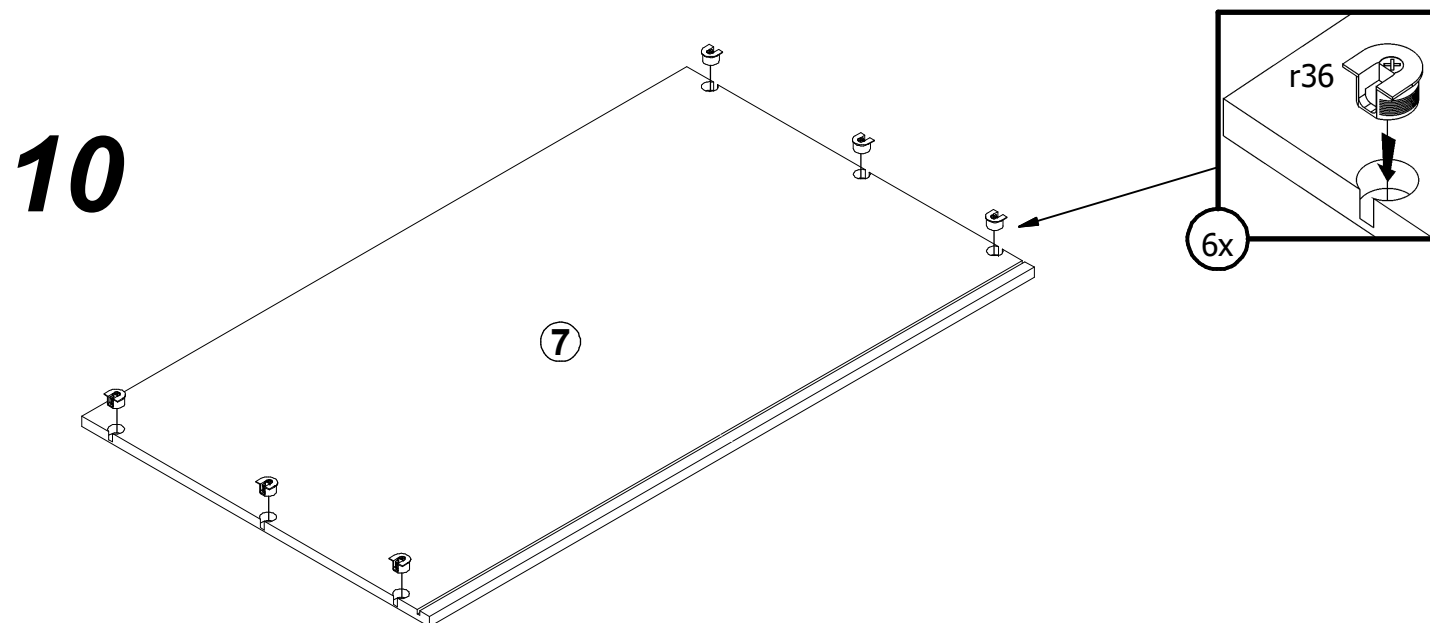
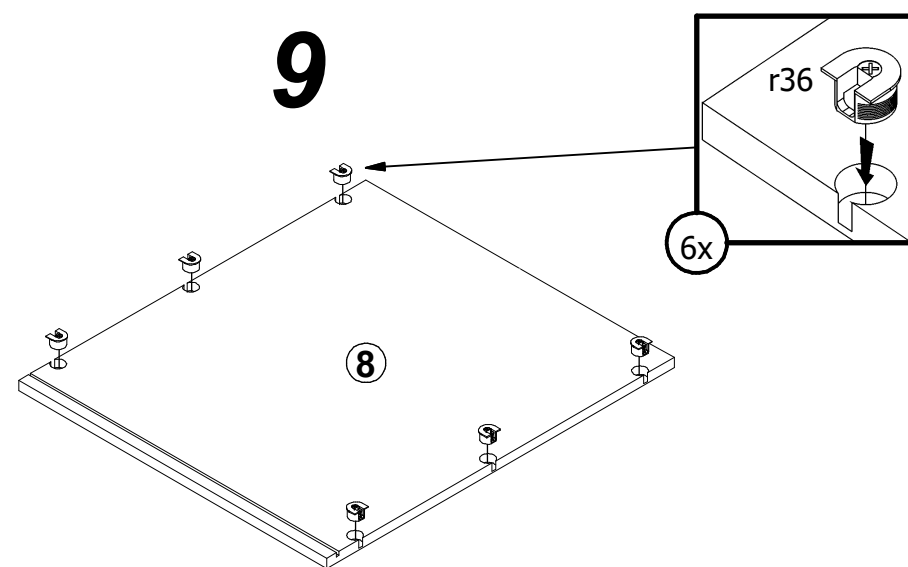
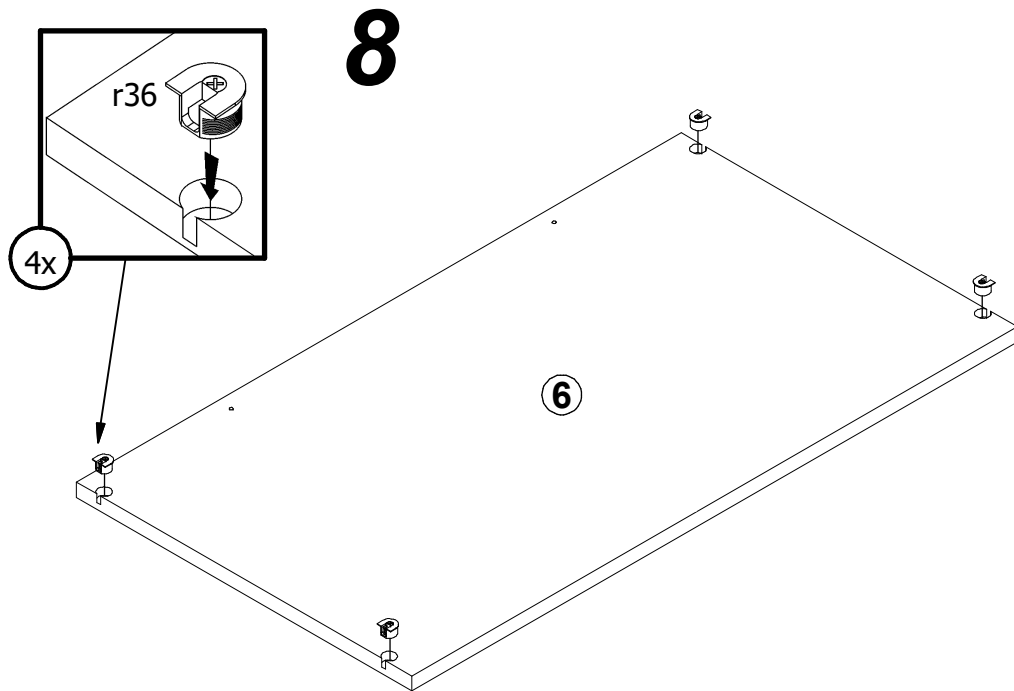

11

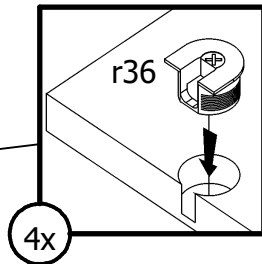
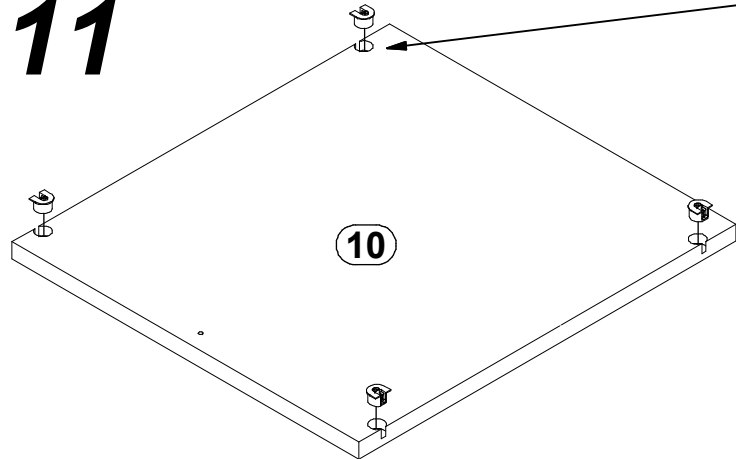

12

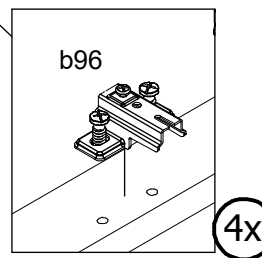
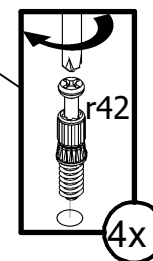
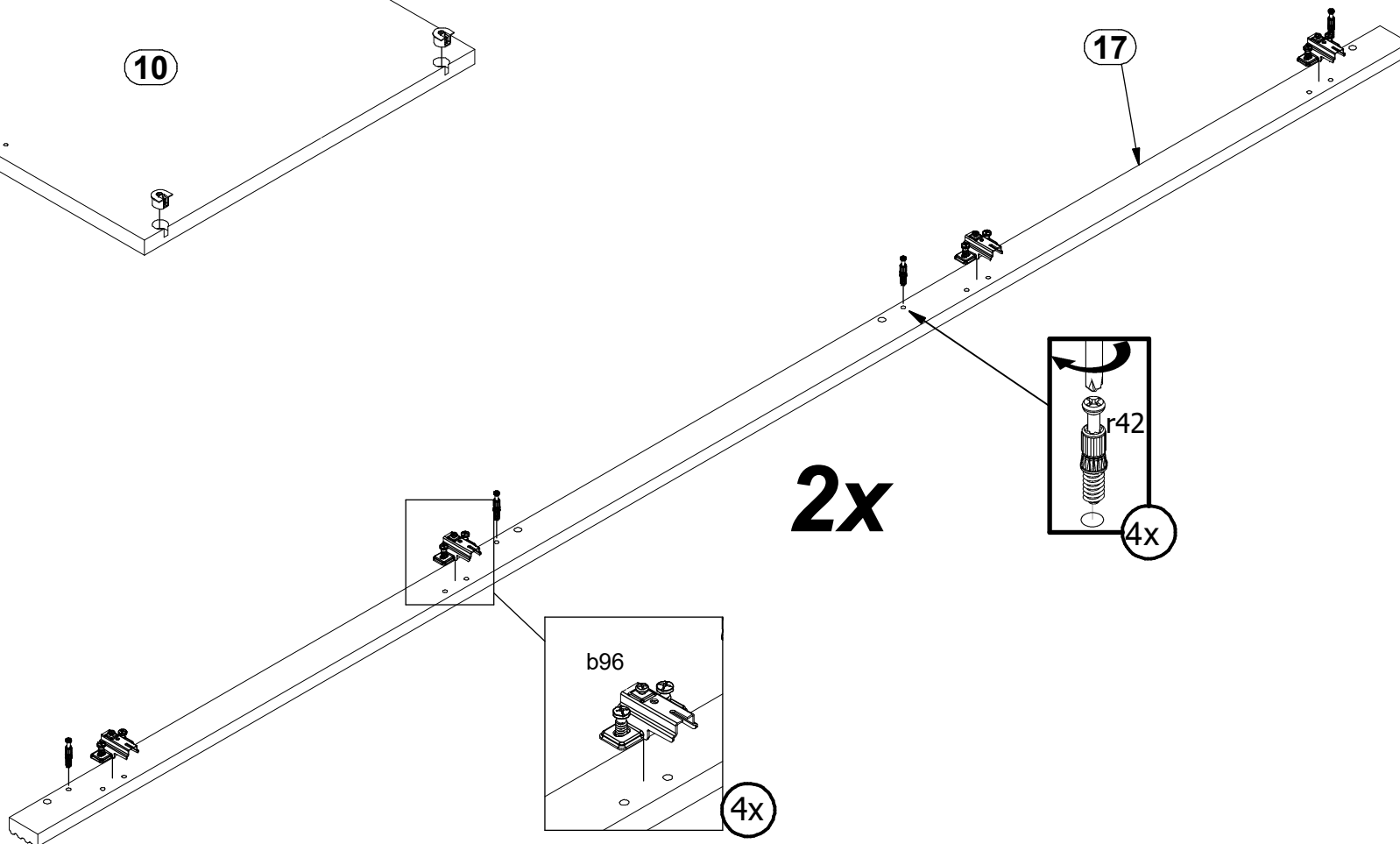

A

L126-SZF2D1L

58-963- --, 58-883- --

12 / 22



13

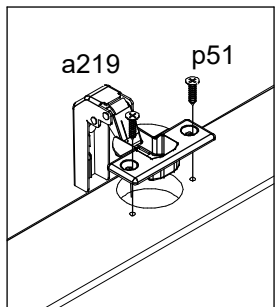

2x

2

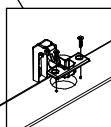
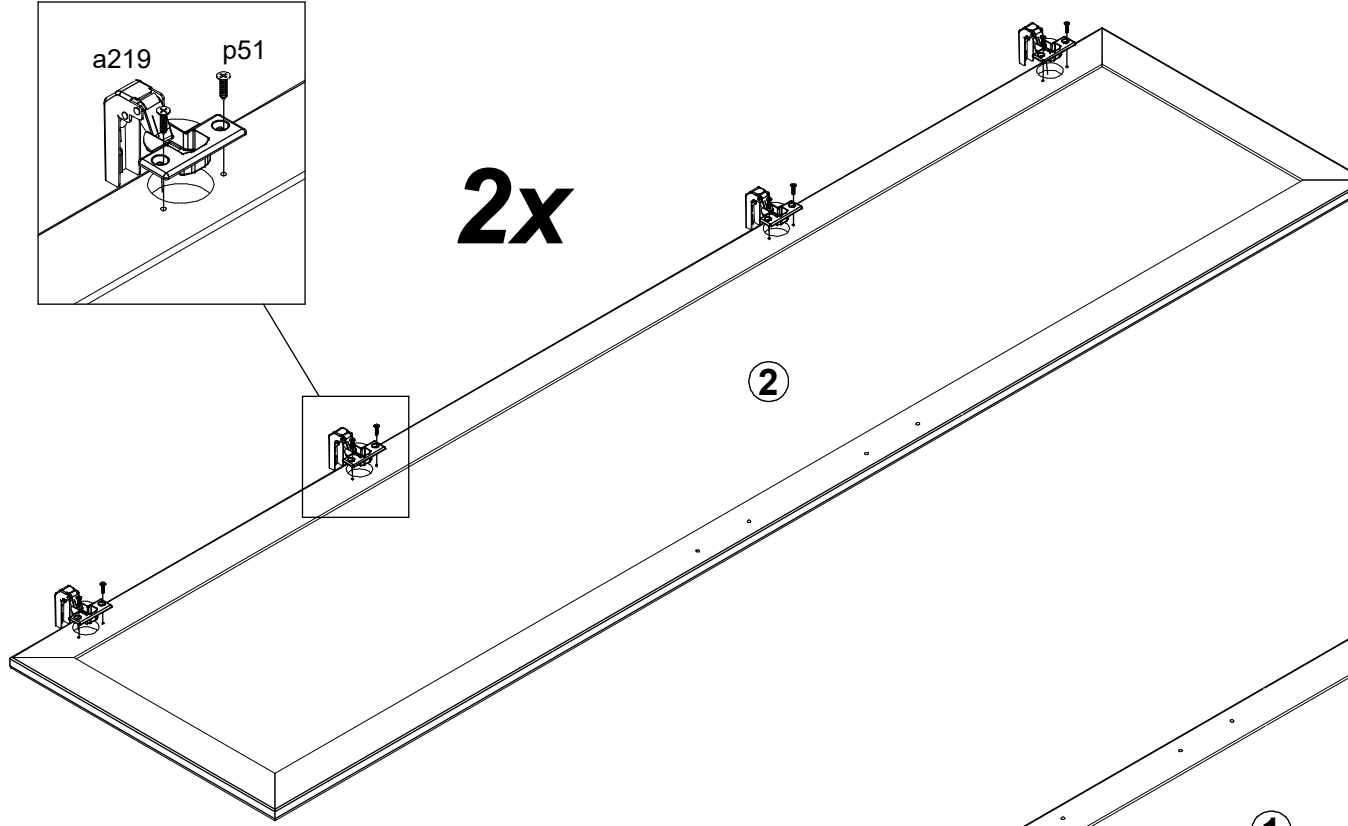

1

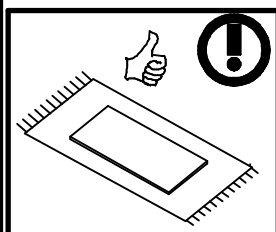
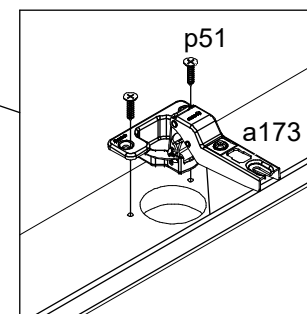
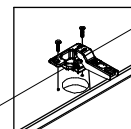

14

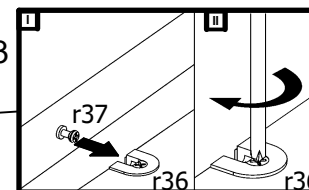
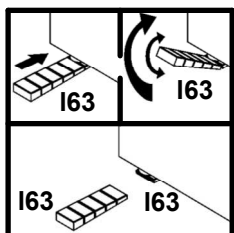
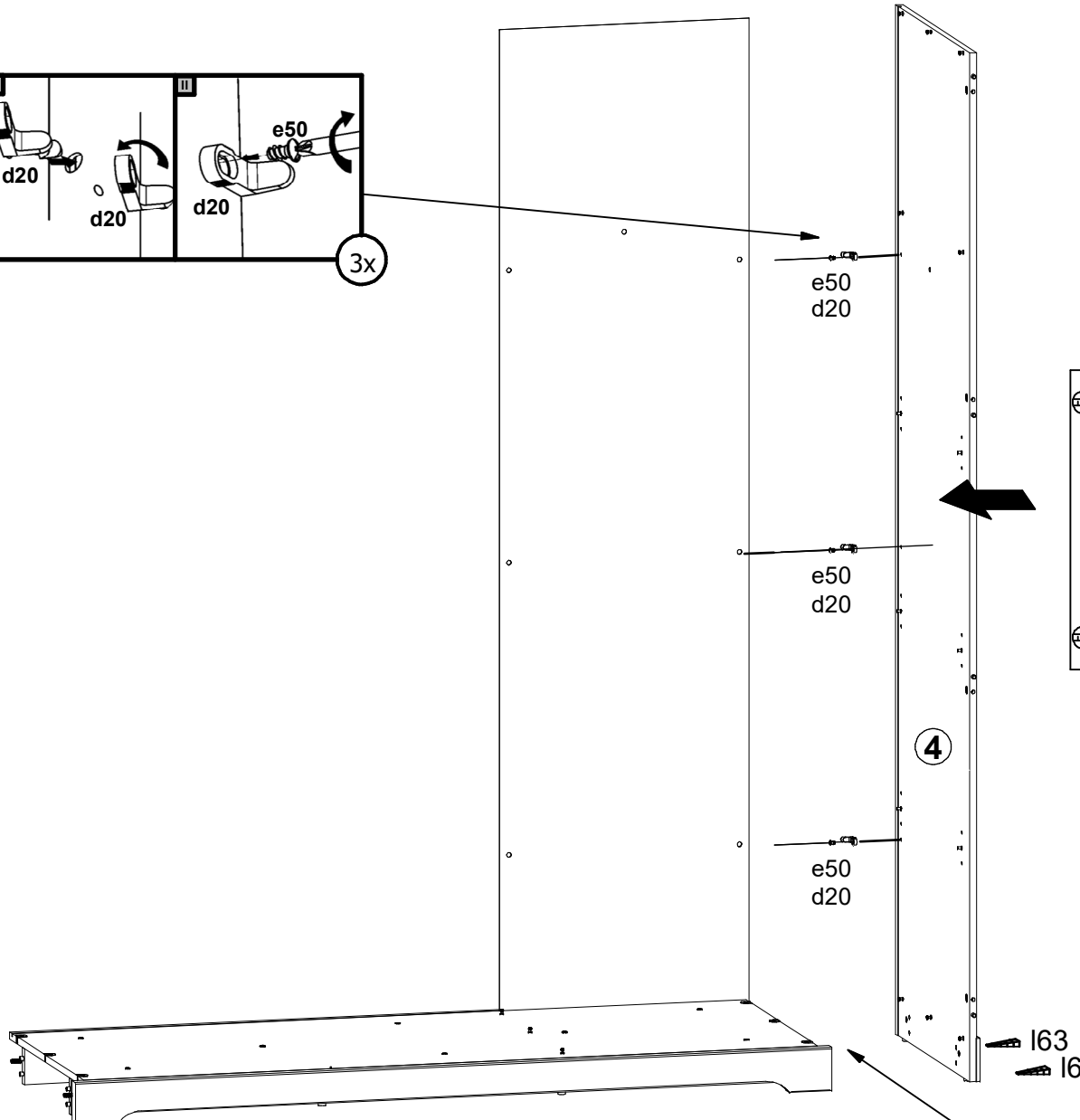
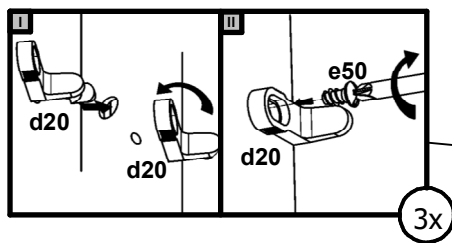

15

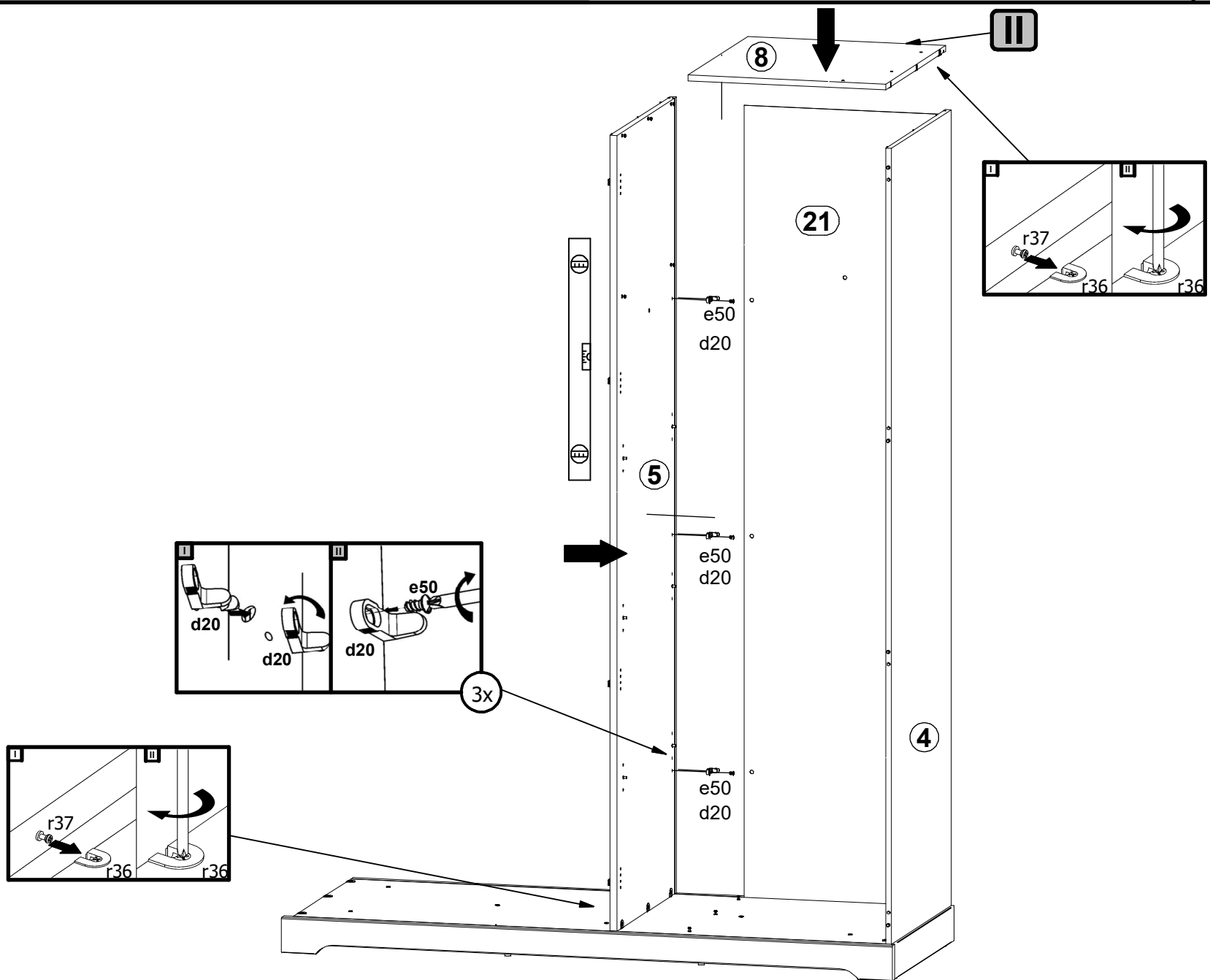

16

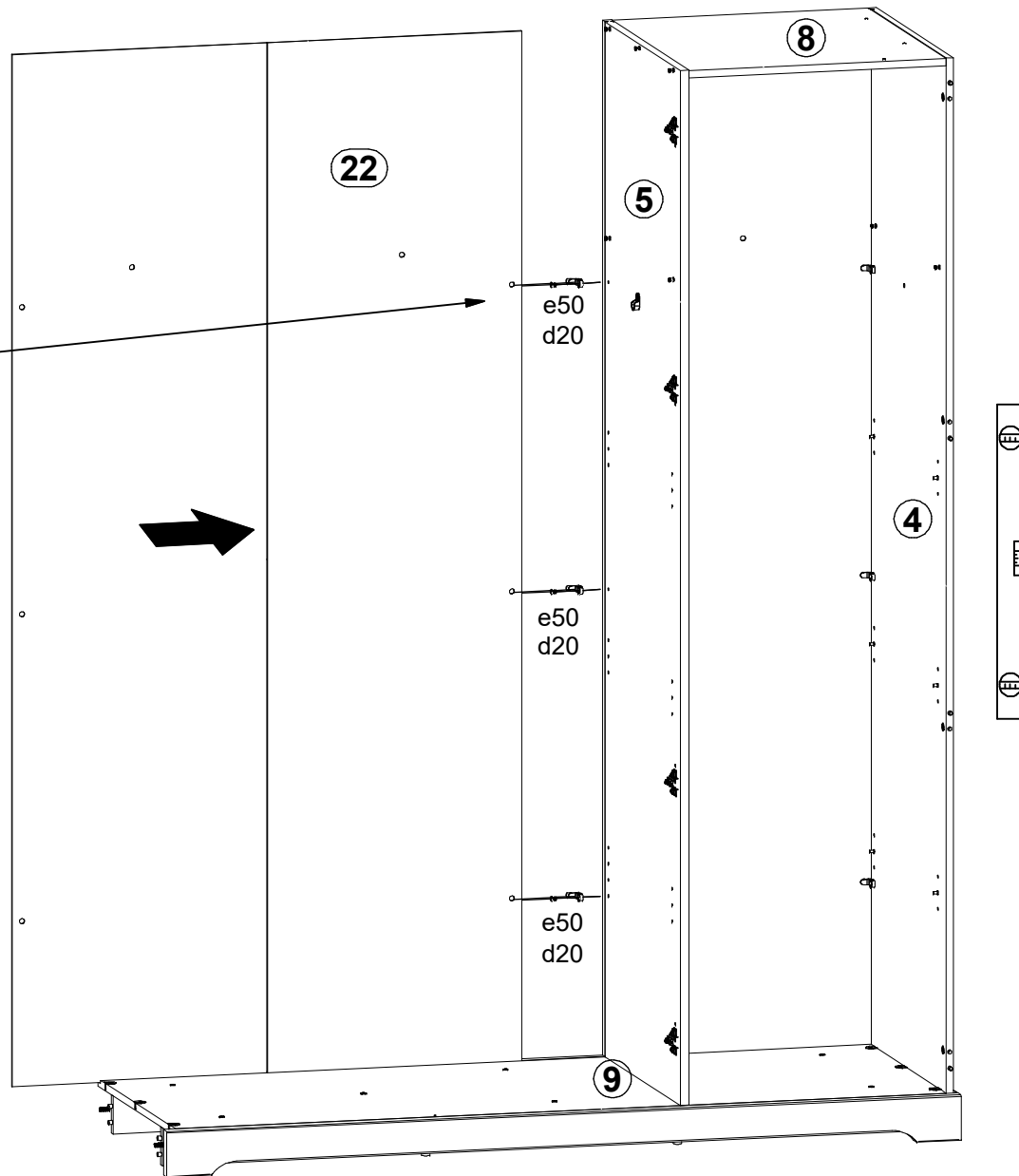
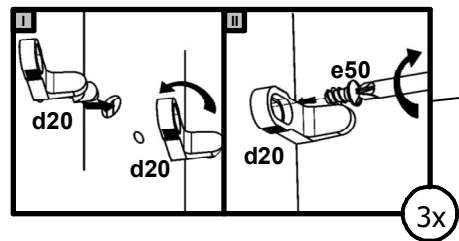

17

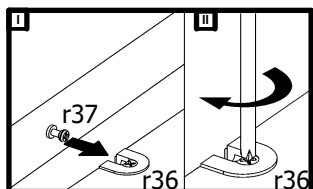
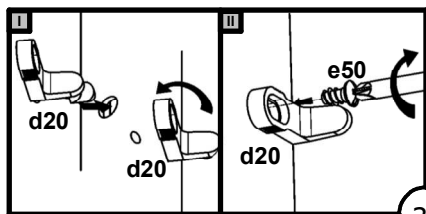
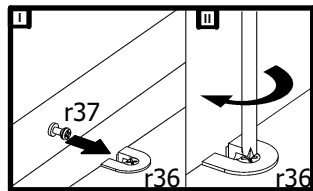

163
163

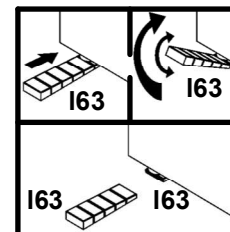
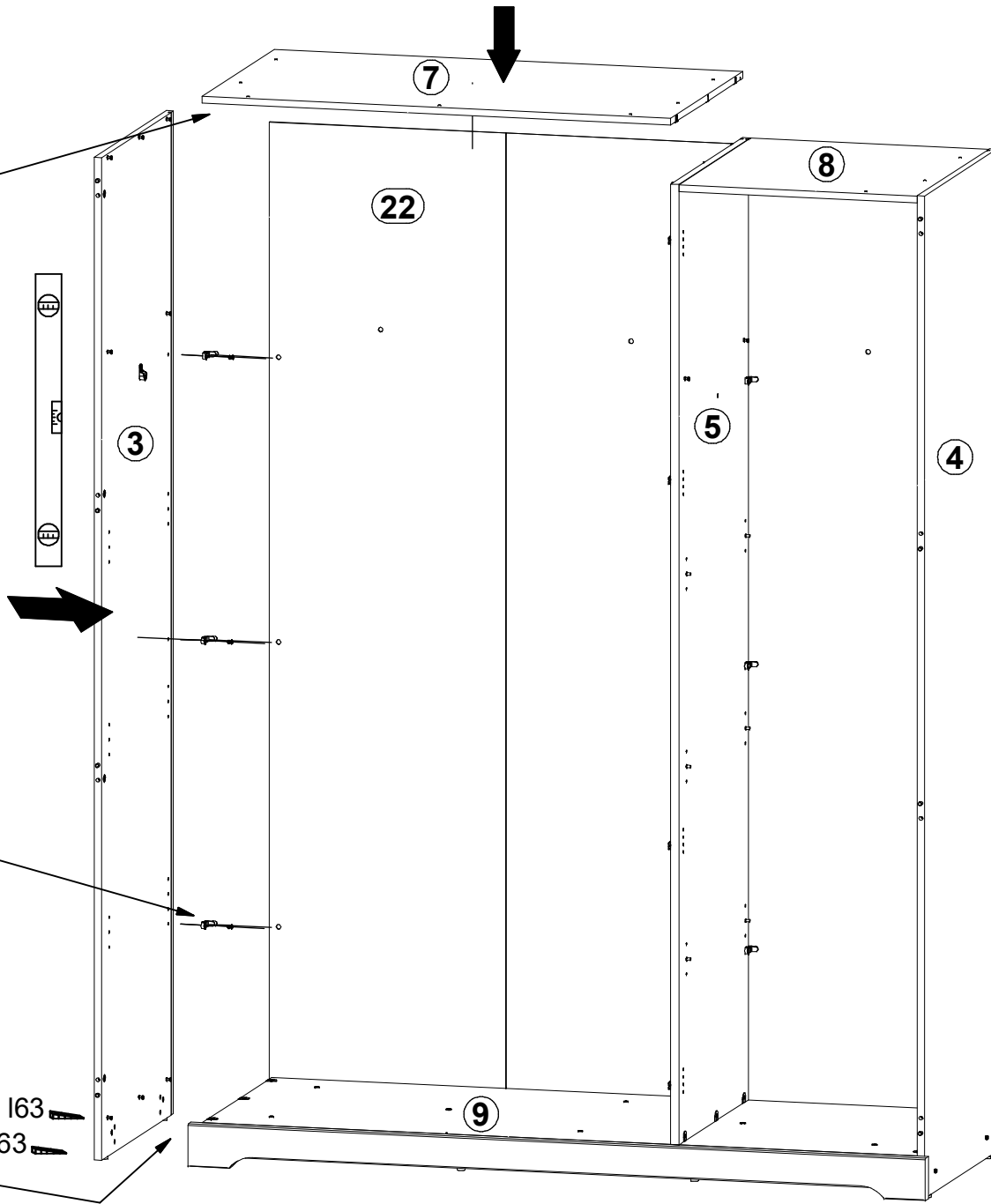

18

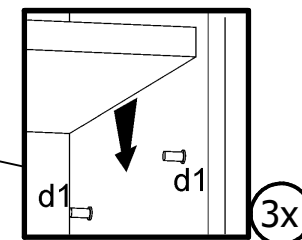
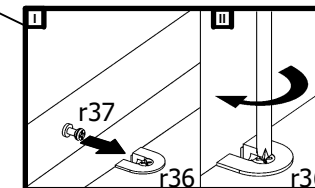
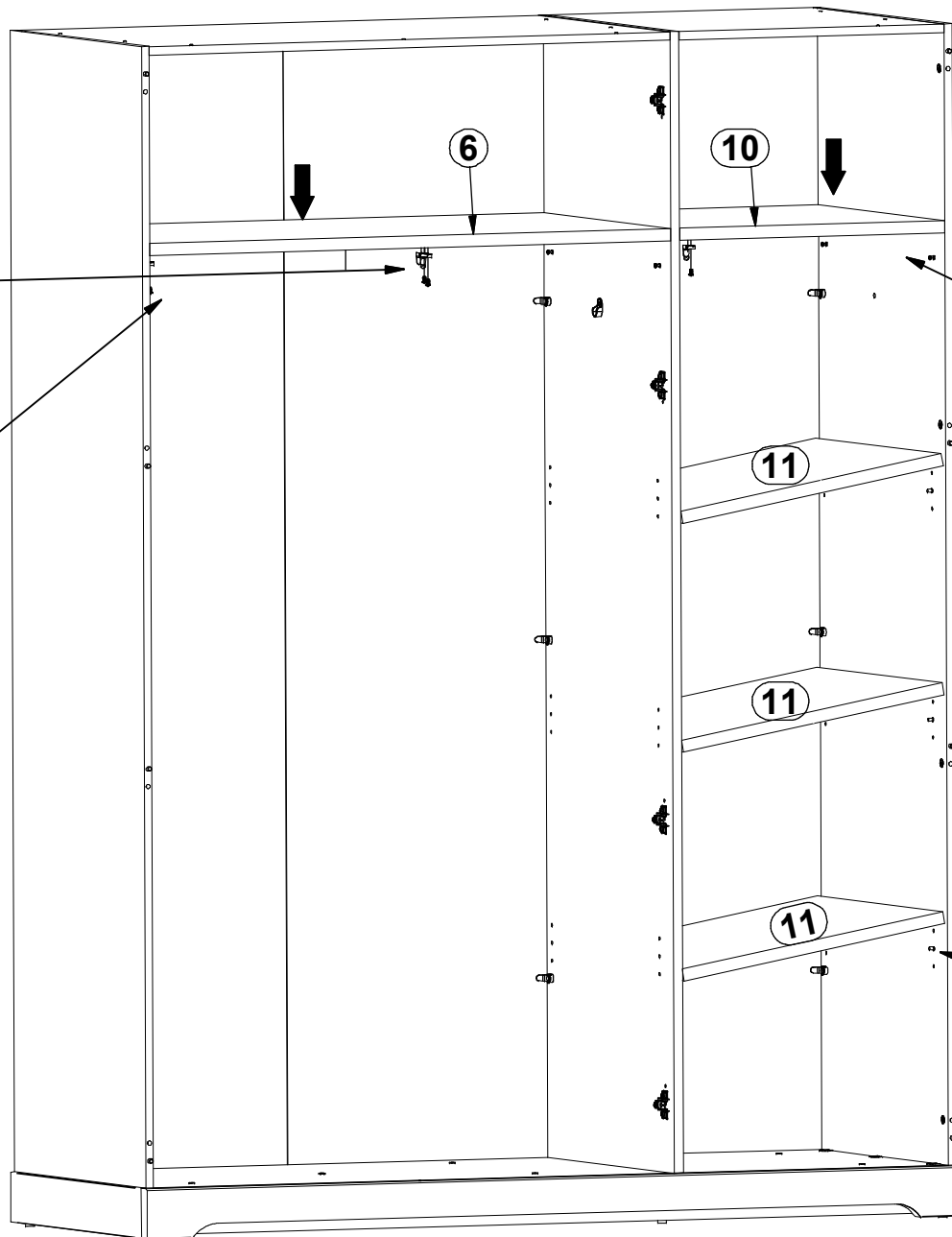
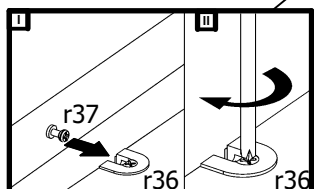
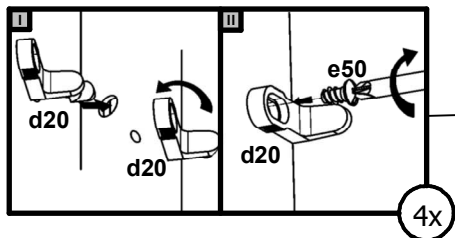

19

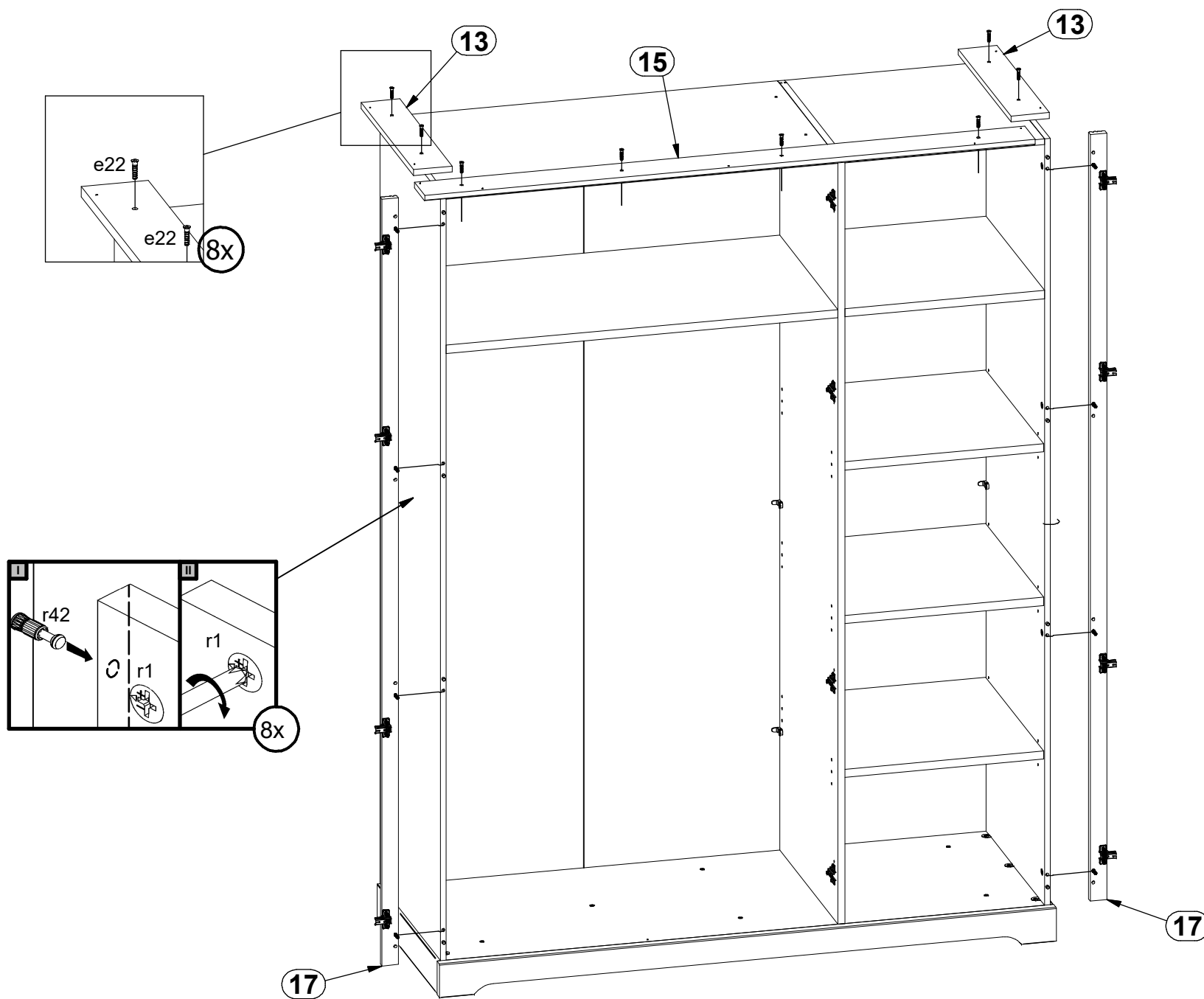

20

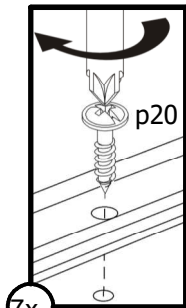

7x

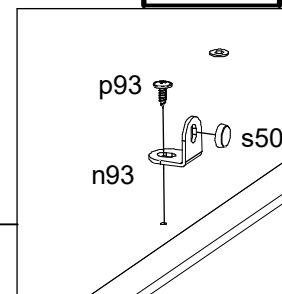
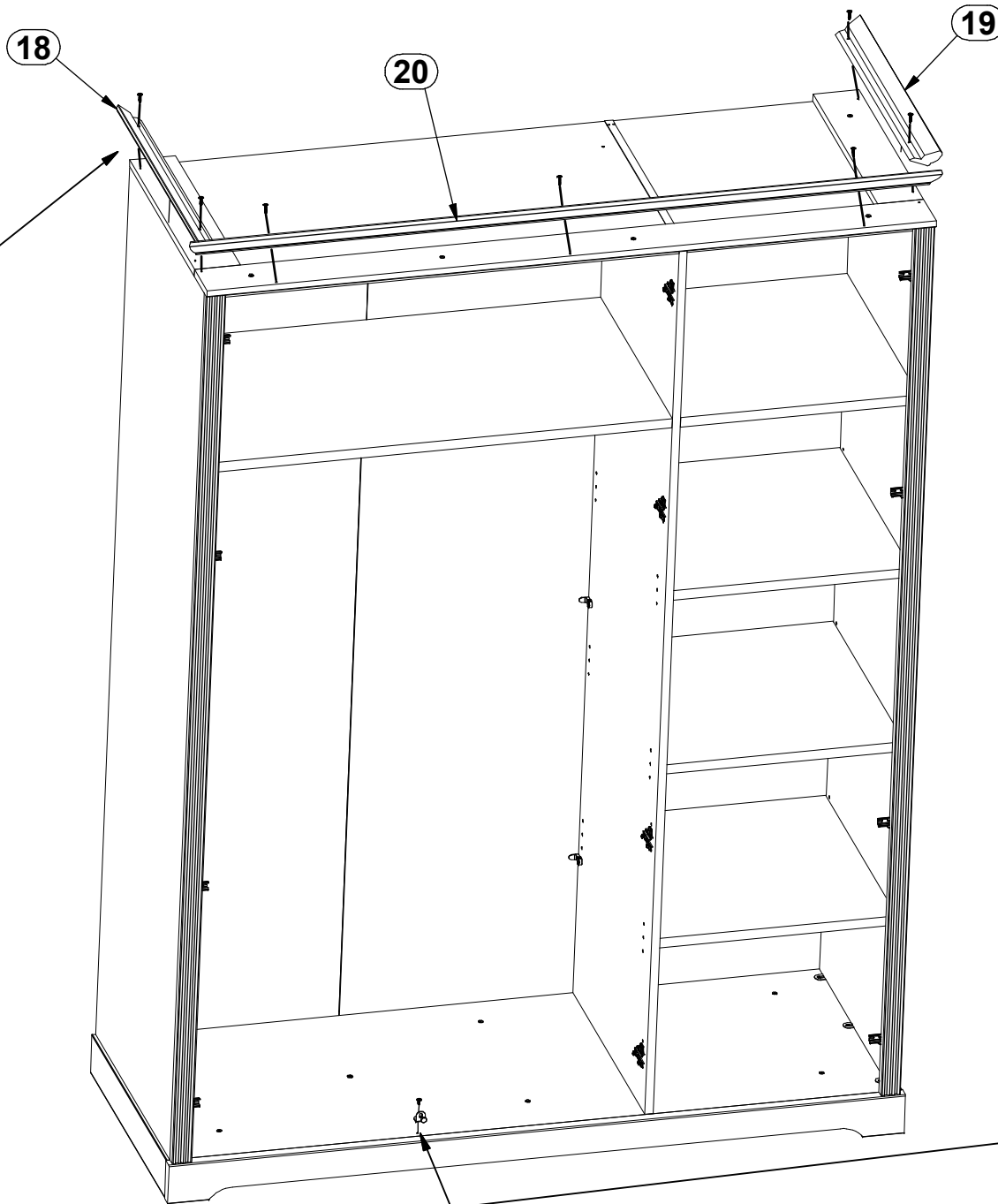

21

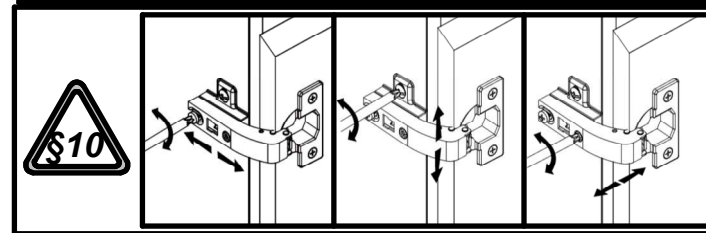
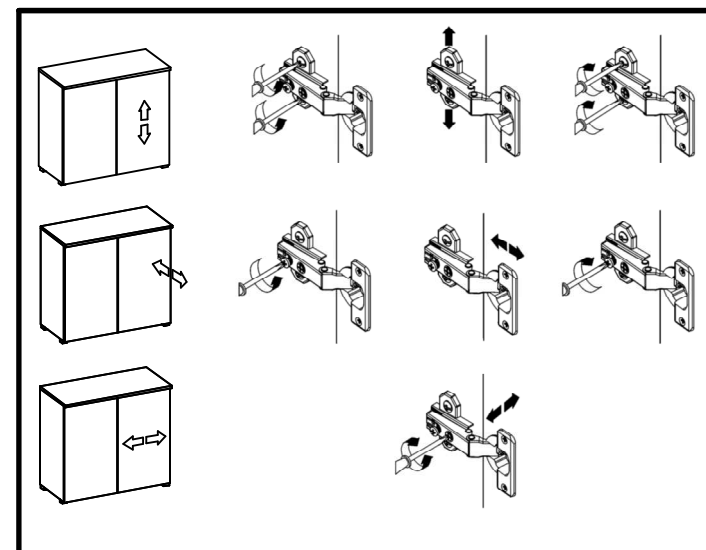
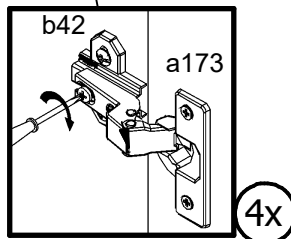
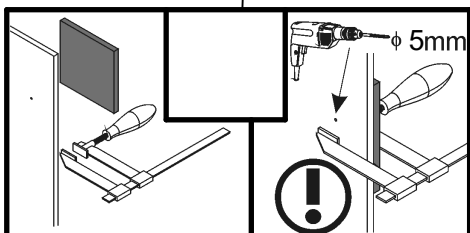
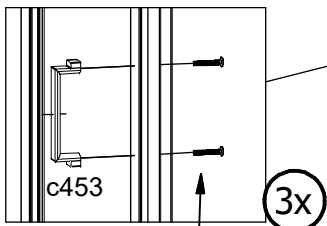
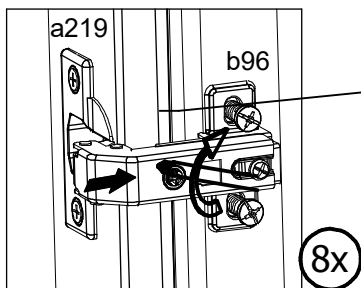
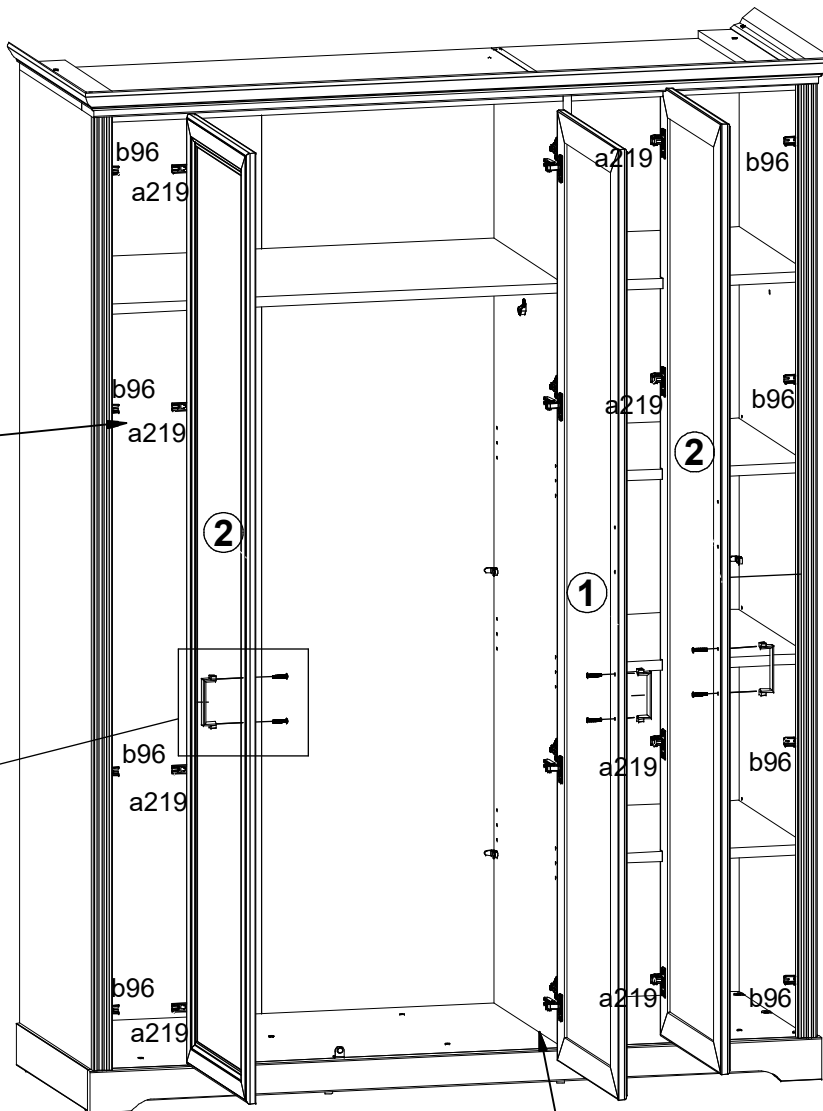

22

