

R2 600x600x320

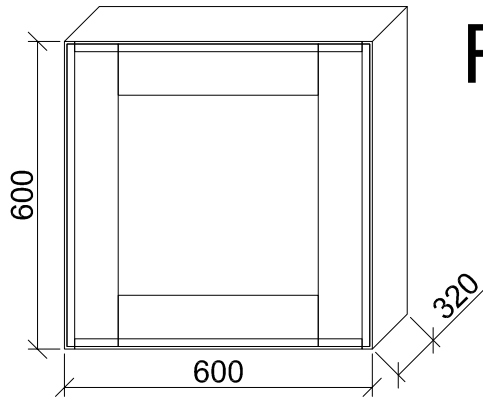

R2

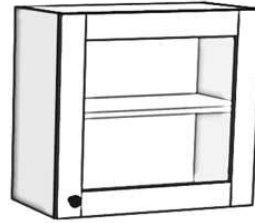



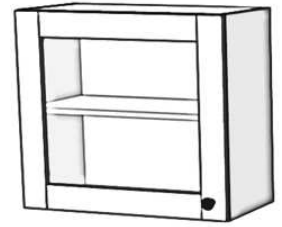

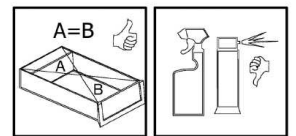
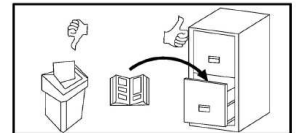
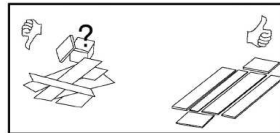
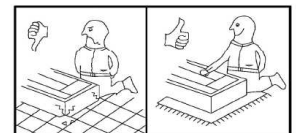
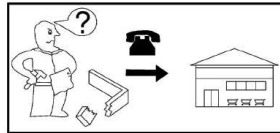
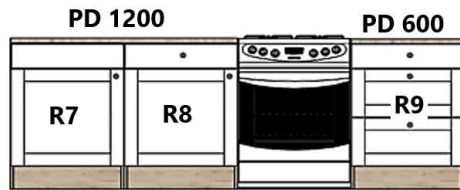
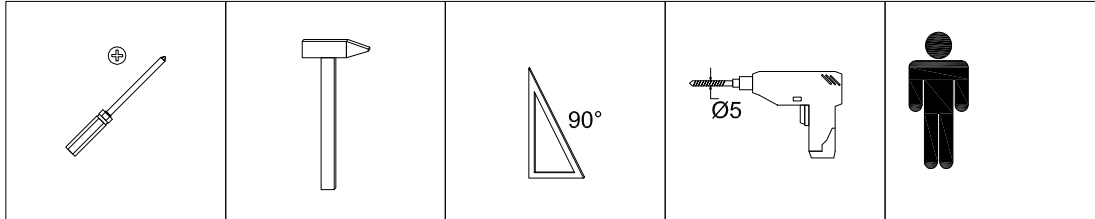

Leve
Vľavo
Links



Vpravo
Prave
Rechts

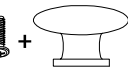
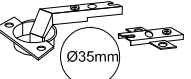
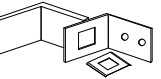

A	x8	C2	x12	F	x30	G	x2	J1	x1	M	x2	L	x2
													

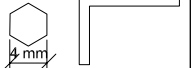
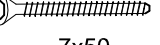
O3	x8	O9	x1	O11	x8
					

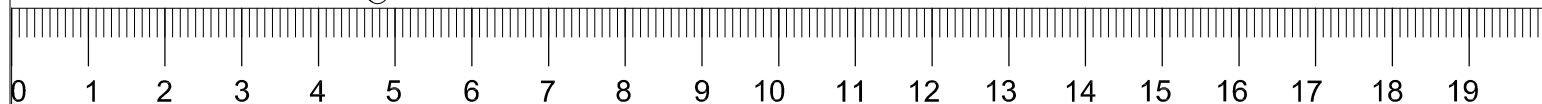
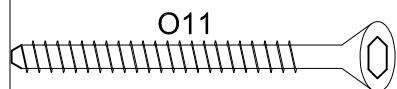

R2 600x600x320

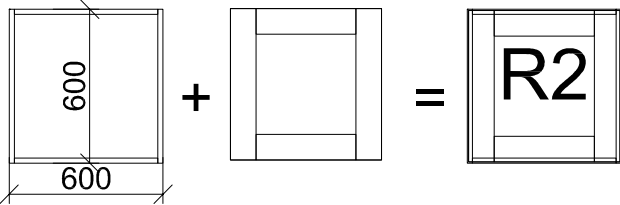
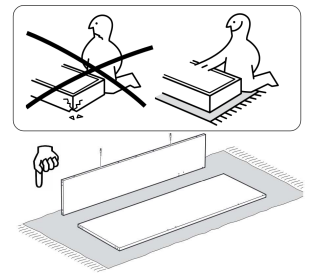

I

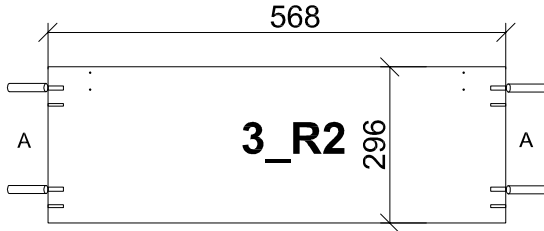
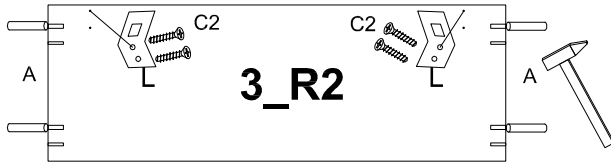

O11

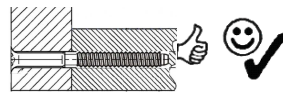

II

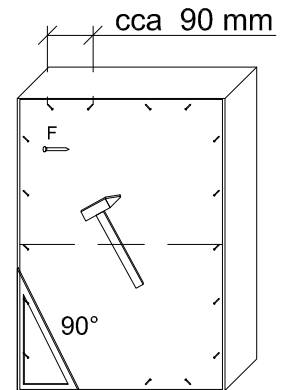
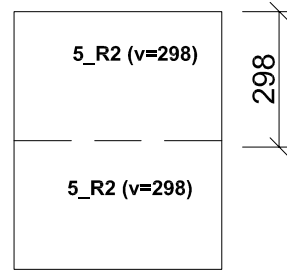
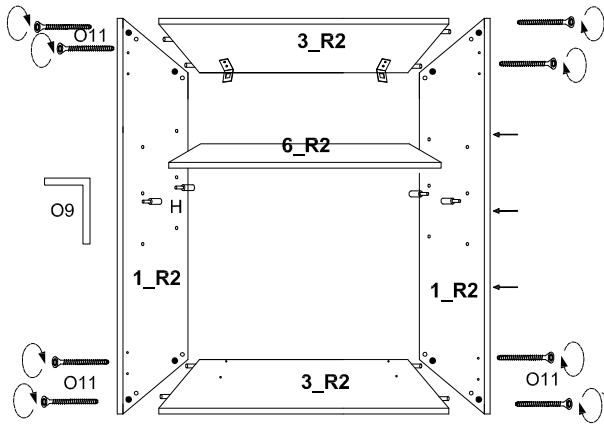

Levo, Lavé, Links

III

Vpravo, Prave, Rechts

