

R3 600x800x320

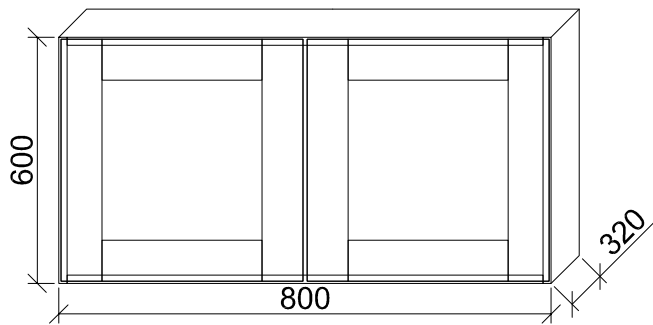

R3

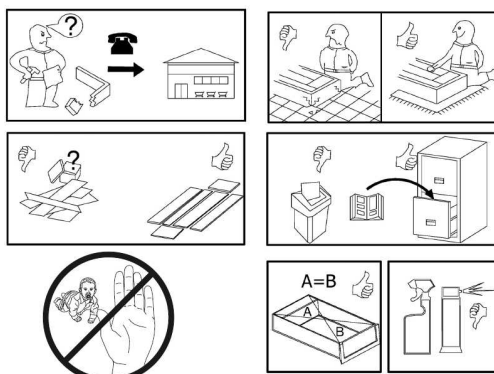
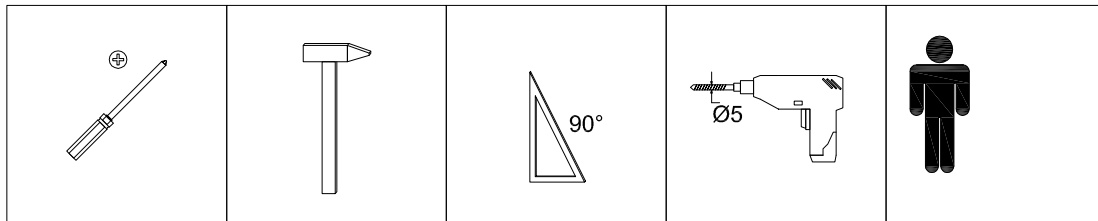
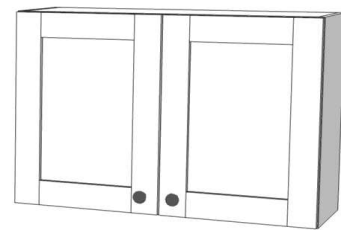

A	x8	C2	x20	F	x40	G	x2	J1	x2	M	x4	L	x2
	8x40		3,5x16mm								Ø35mm		

O3	x8	O9	x1	O11	x8
	Ø13mm		4mm		7x50

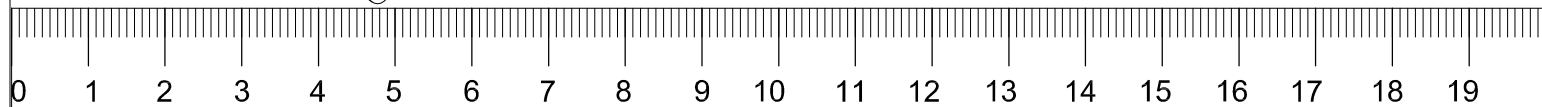
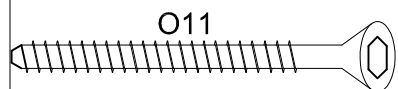

R3 600x800x320

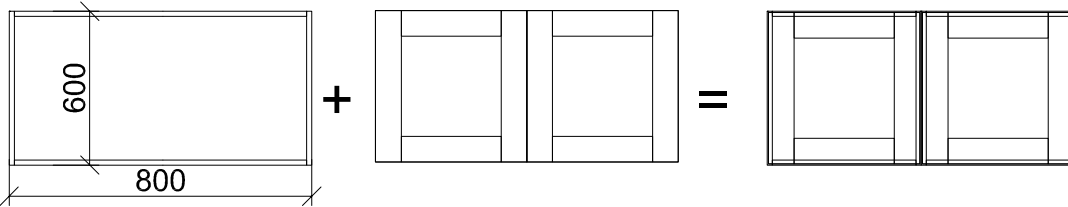
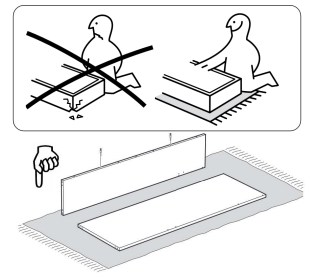

I

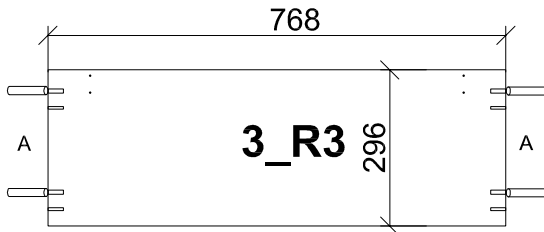
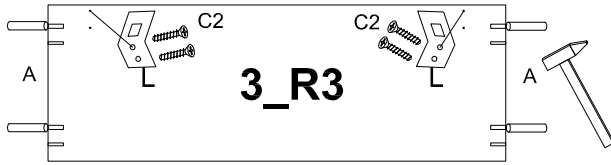

O11

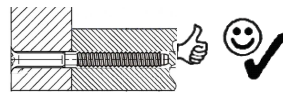

II

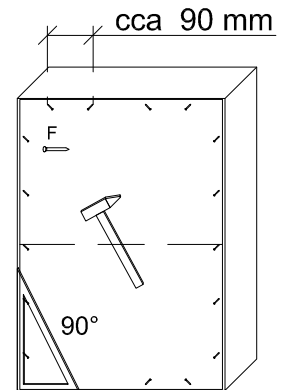
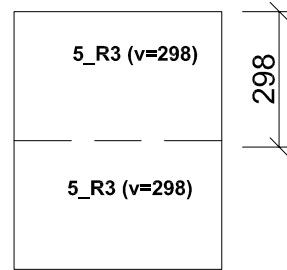
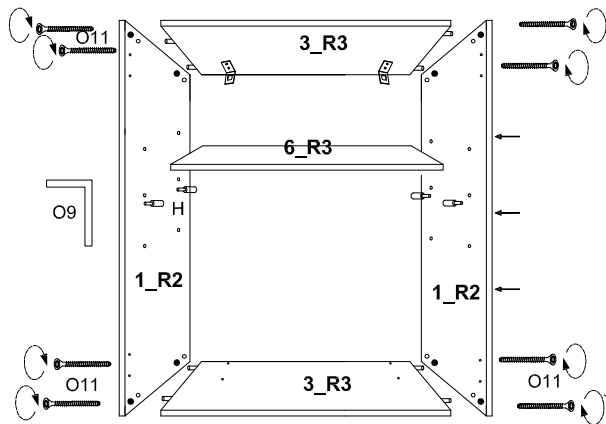

III

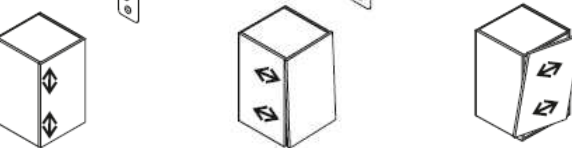
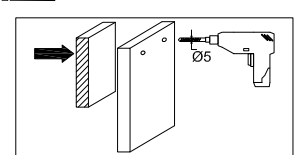
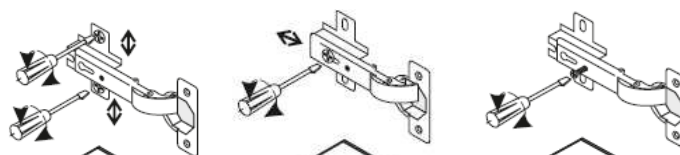
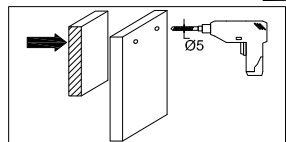
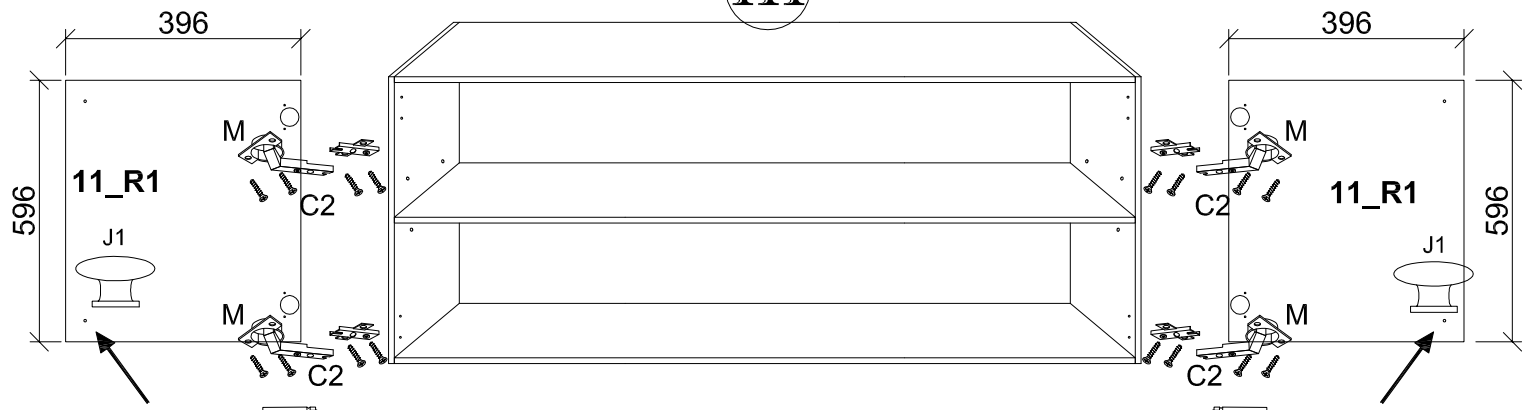

G x2

