

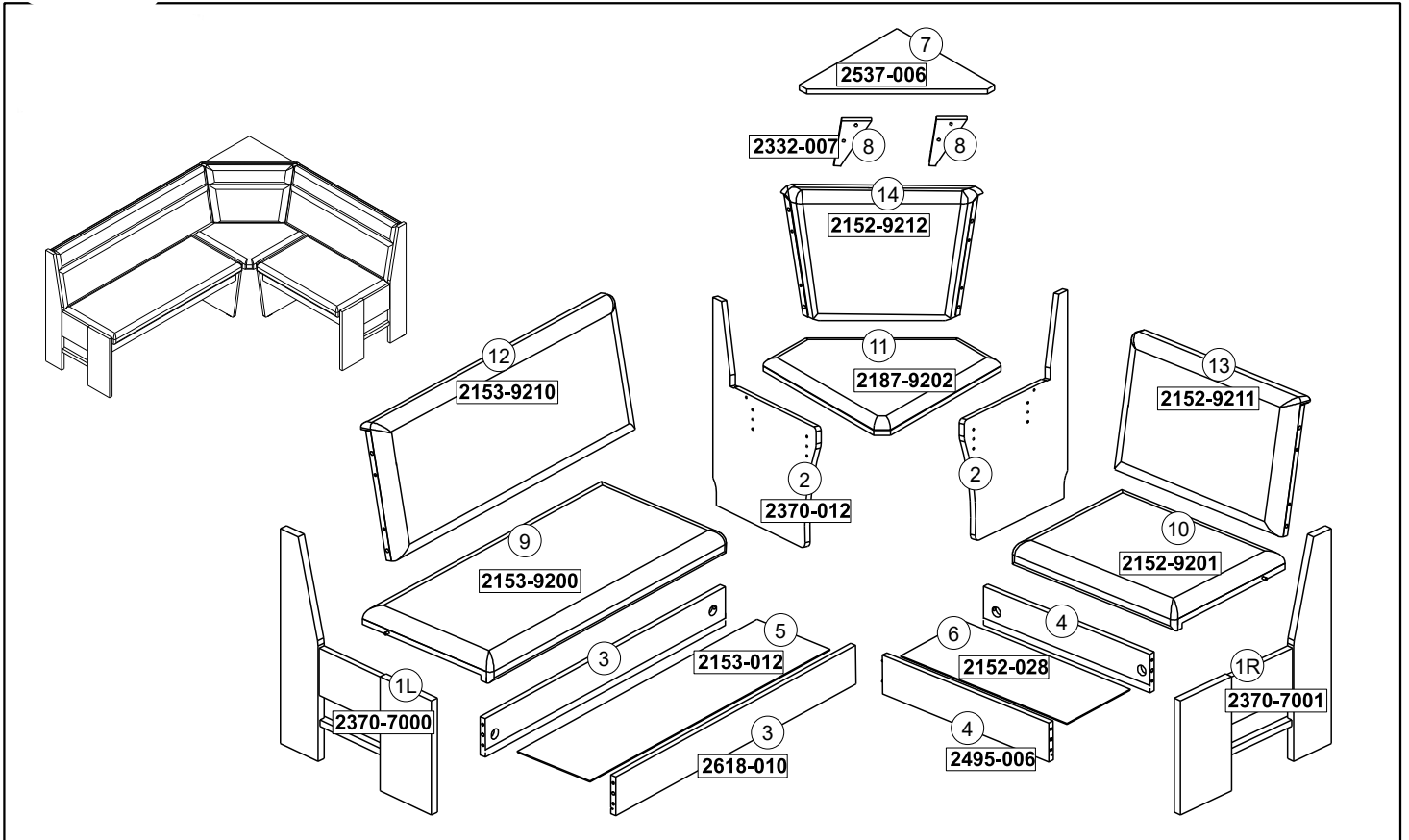











# ASSEMBLY INSTRUCTION CORNER BENCH - AUFBAUANLEITUNG - INTRUKCJA MONTAŻU - MONTÁŽNÍ NÁVOD

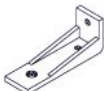

## LIST OF FURNITURE HARDWARE - BESCHLAGTEILE - OKUCIE ŁĄCZĄCE - SPOJOVACÍ KOVÁNÍ

|  |  |   |   |  |   |
|--|--|---|---|--|---|
| <b>A</b><br><br>M6x30   <b>8x</b> | <b>B</b><br><br>M6x45   <b>8x</b> | <b>C</b><br><br><b>16x</b> | <b>D</b><br><br>M6   <b>8x</b> | <b>E</b><br><br>4x16   <b>11x</b> | <b>F</b><br><br>4x30   <b>6x</b> |
| <b>G</b><br><br>8x40   <b>28x</b> | <b>H</b><br><br><b>4x</b>         | <b>I</b><br><br><b>1x</b>  | <b>J</b><br><br><b>6x</b>      | <b>K</b><br><br><b>12x</b>        | <b>L</b><br><br><b>1x</b>        |

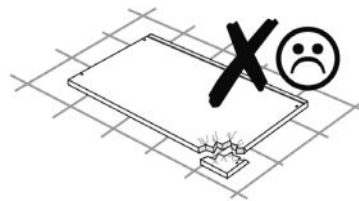
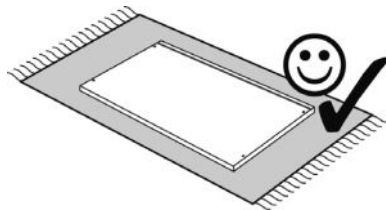

Here, you can measure the furniture hardware to recognise a certain part according to its size. All proportions are in millimetre.

Hier können Sie die Schrauben zur besseren Identifizierung nachmessen (alle Maßangaben in mm).

Tutaj mogą sobie Państwo zmierzyć okucie do dokładnego ustalenia rodzaju według rozmiarów. Wszystkie rozmiary podawane są w milimetrach.

Zde si můžete změřit kování k přesnému určení typu dle velikosti. Všechny rozměry jsou uvedeny v milimetrech.

60 min.

