

# MEMPHIS 50 34--23

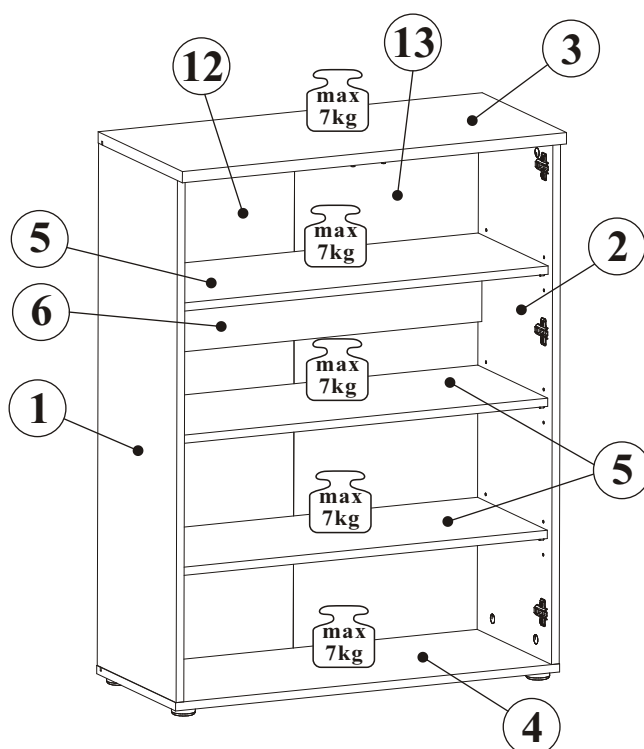

číslo	rozměry/rozmary			č.balíku	počet
1	1012	350	16	1	1
2	1012	350	16	1	1
3	802	374	22	1	1
4	802	350	16	1	1
5	768	310	16	1	3
6	768	80	16	1	1
7	396	860	18	2	1
8	396	860	18	2	1
9	396	156	18	2	1
10	396	156	18	2	1
11	379	100	12	1	2
12	1024	390	3	2	1
13	1024	390	3	2	1

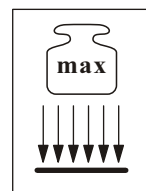

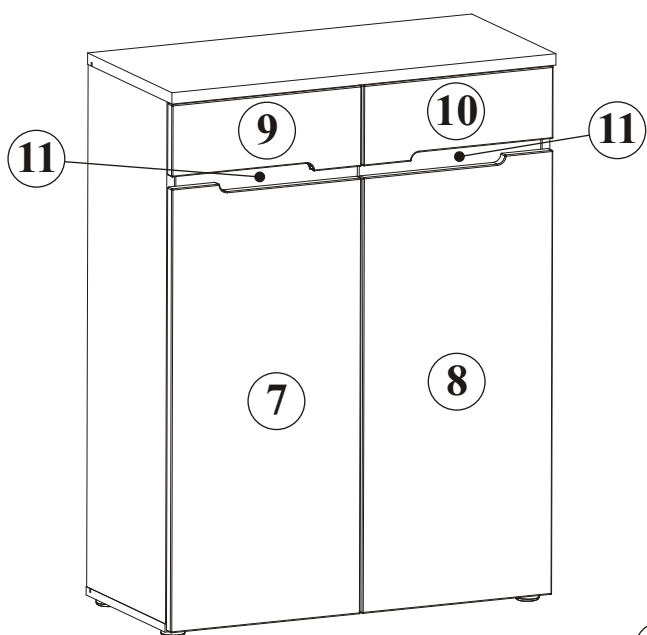
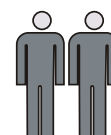

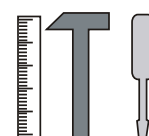

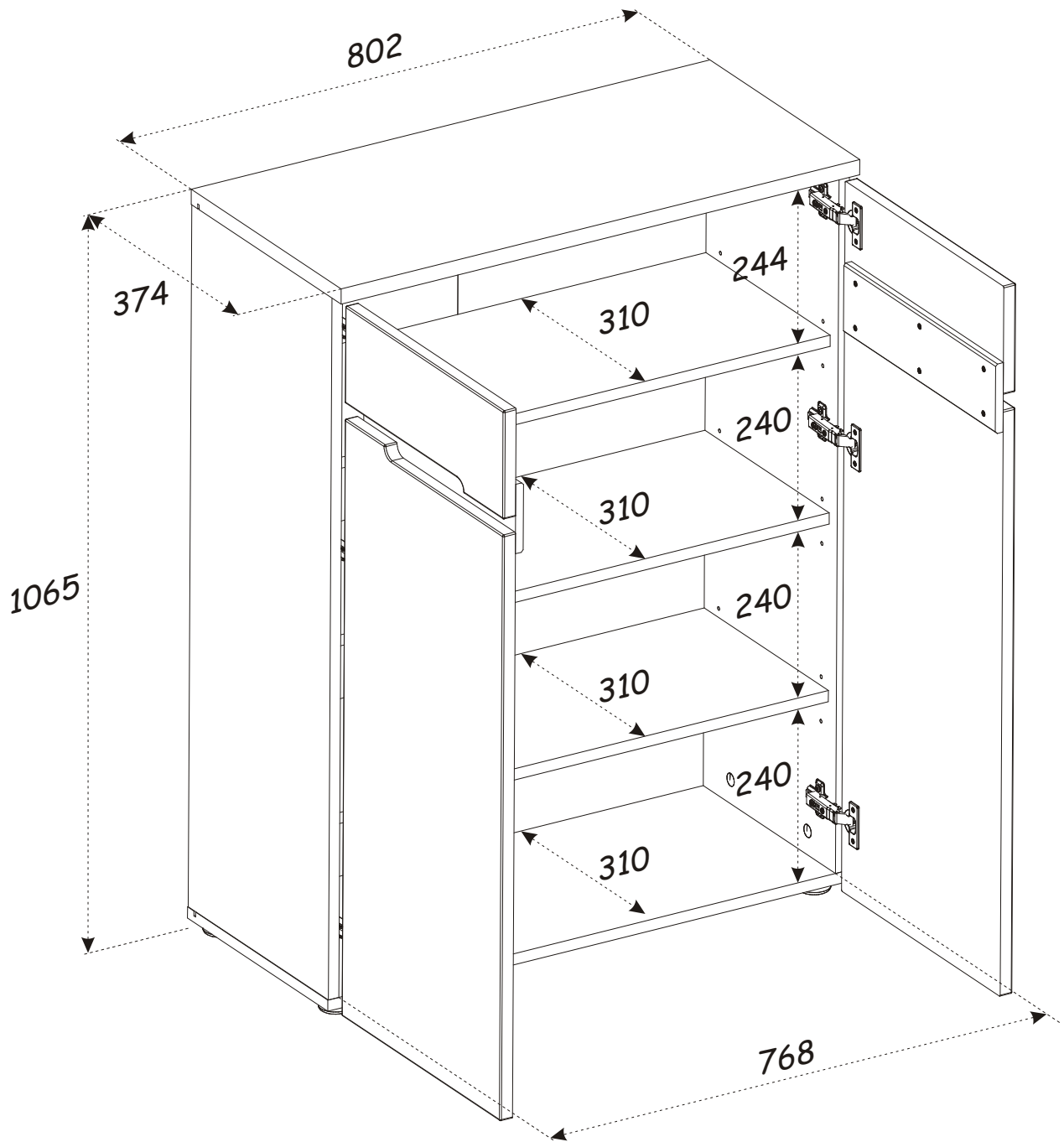

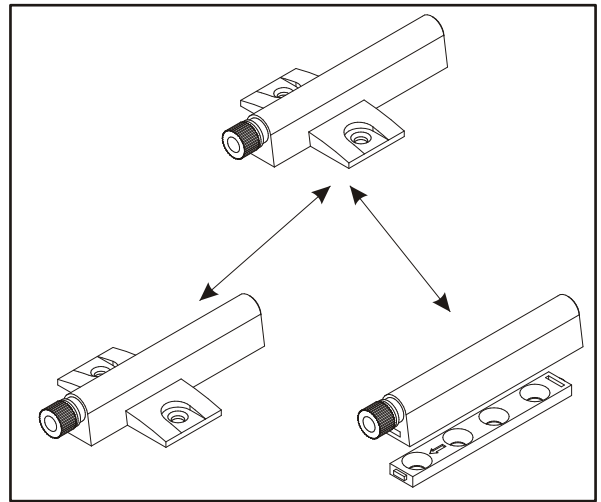
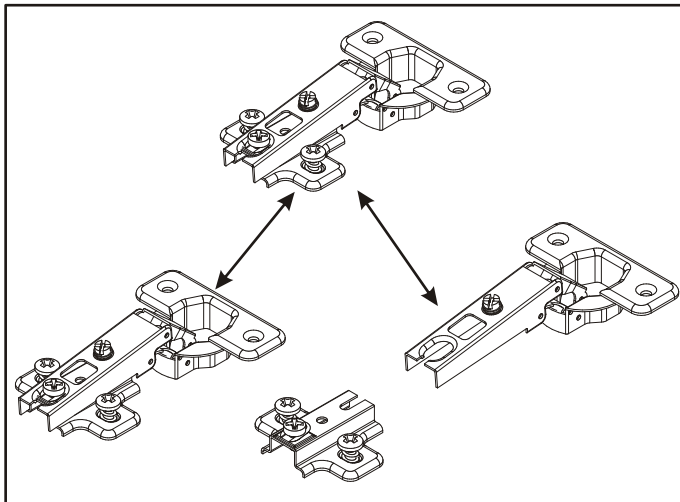
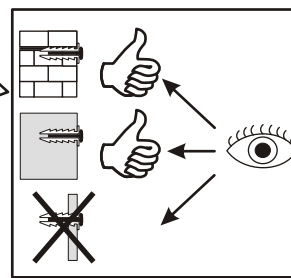
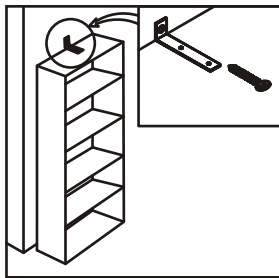
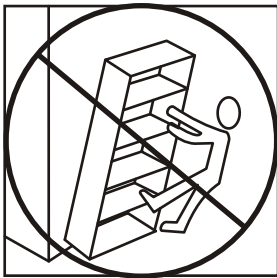
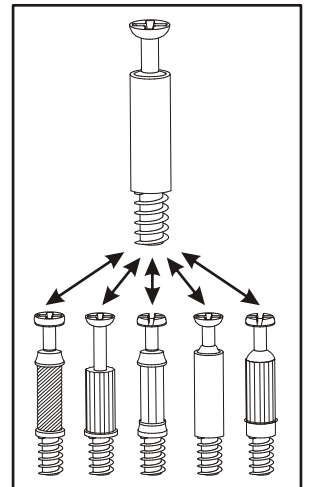
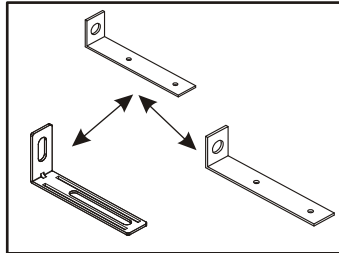
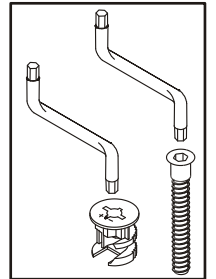
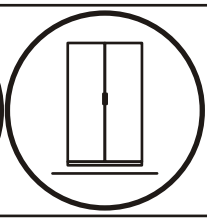
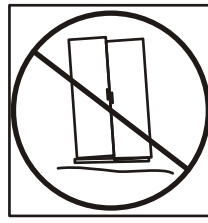
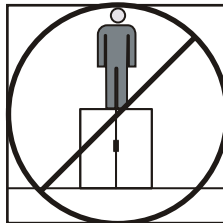
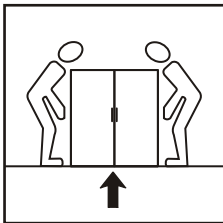
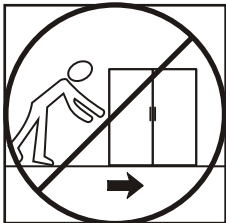
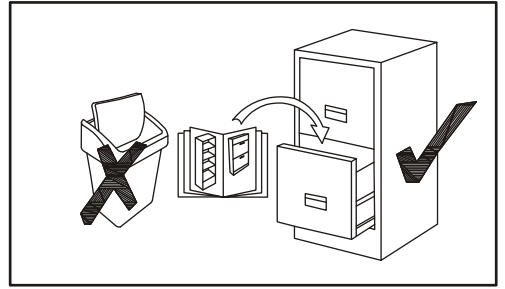
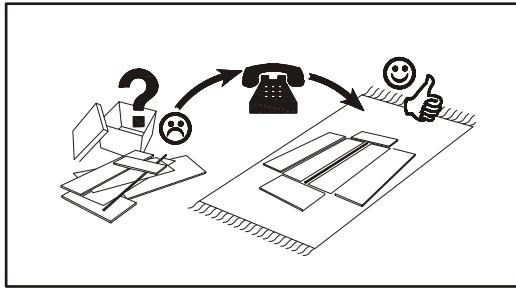
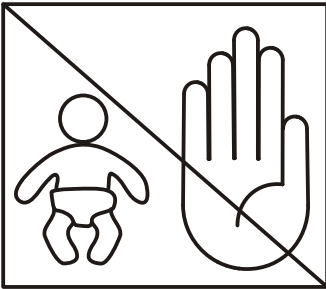
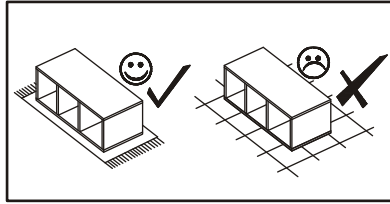
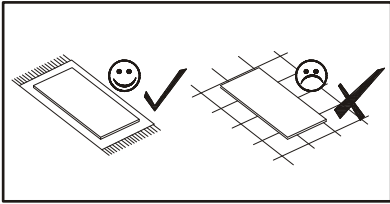

180 min

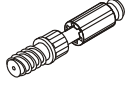

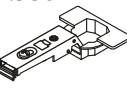

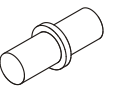
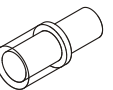
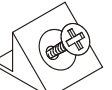
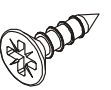
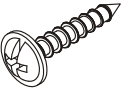

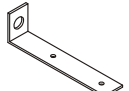

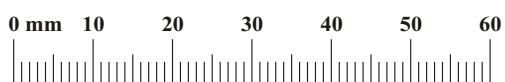
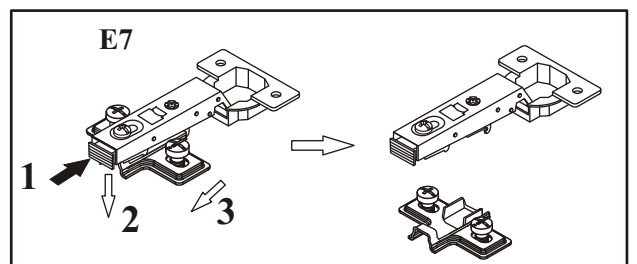
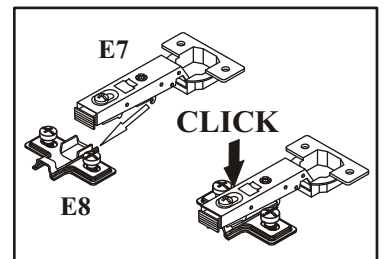

MEMPHIS 50 34 -- 23

A1 x10  ø8x36	B4 x10 	B5 x10  ø15x12	G5 x10 	E7 x6  Ø35 H=0	E8 x6  H=0
I11 x4  Ø45, h=15	G7 x12 	G20 x2 	S1 x16 	D10 x14  USØ3,5x13	UP11 x4  UPØ4x20
UP17 x12  UPØ4x25	L1 x1 	KR1 x1 	G2 x1 		

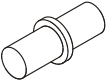
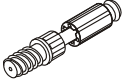



1

G7		B4		B5		E8	
x6		x1		x4	$\phi 15 \times 12$	x3	H=0

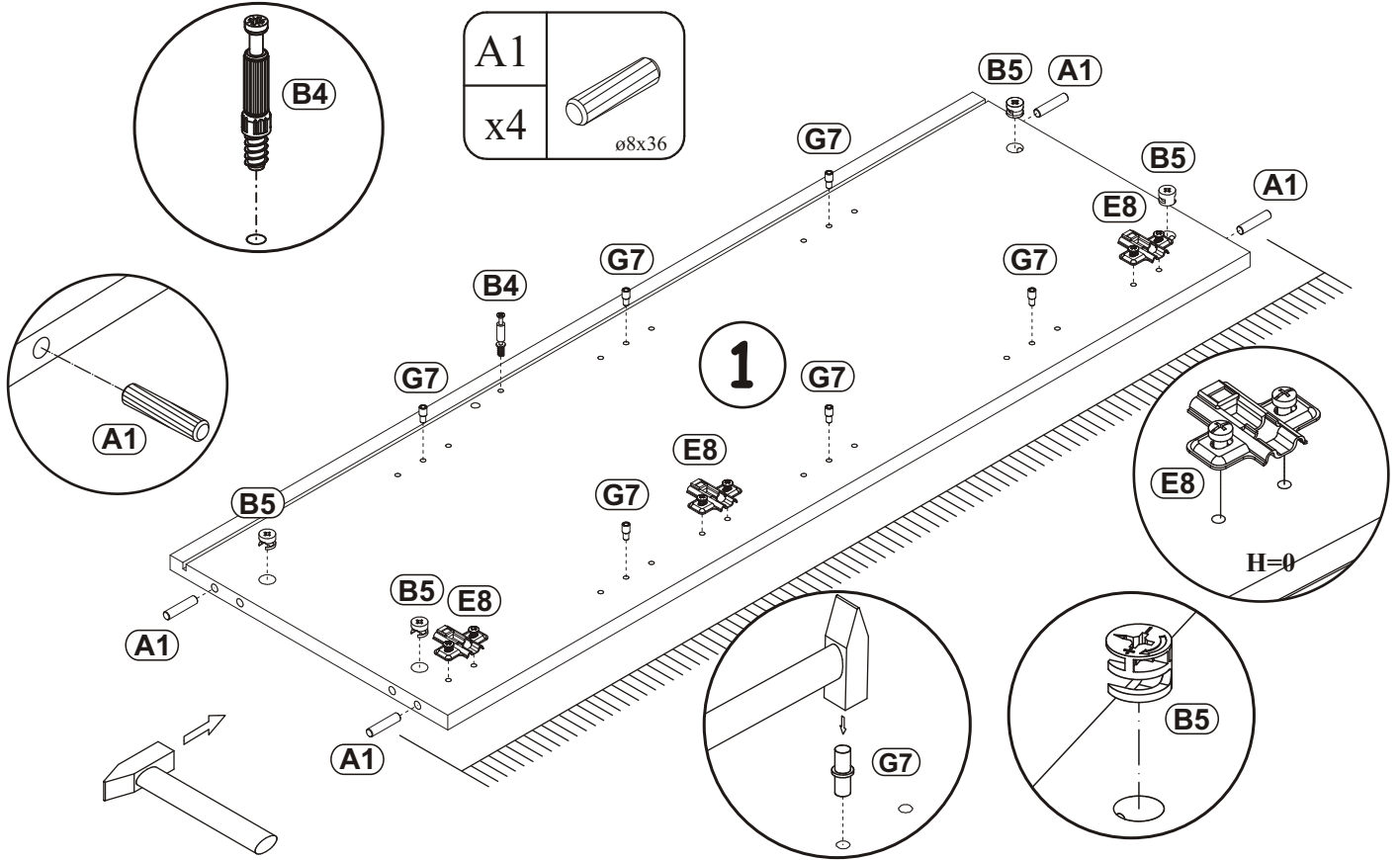
A1	
x4	$\phi 8 \times 36$



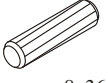
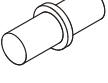
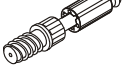

2

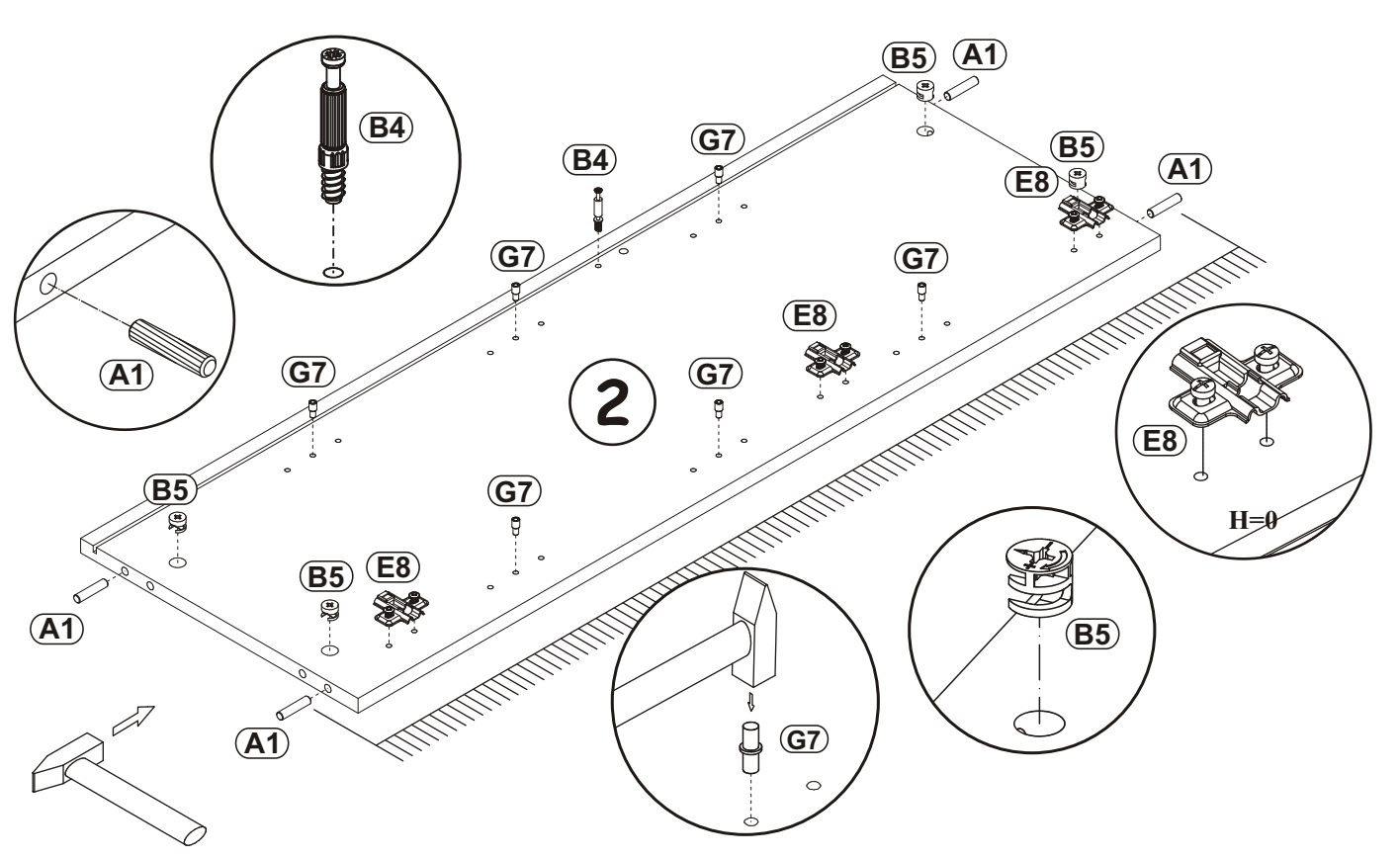
A1		G7		B4		B5		E8	
x4	$\phi 8 \times 36$	x6		x1		x4	$\phi 15 \times 12$	x3	H=0

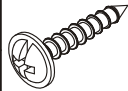

3

UP11	
x4	UPØ4x20

I11	
x4	Ø45, h=15

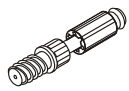
B4	
x4	

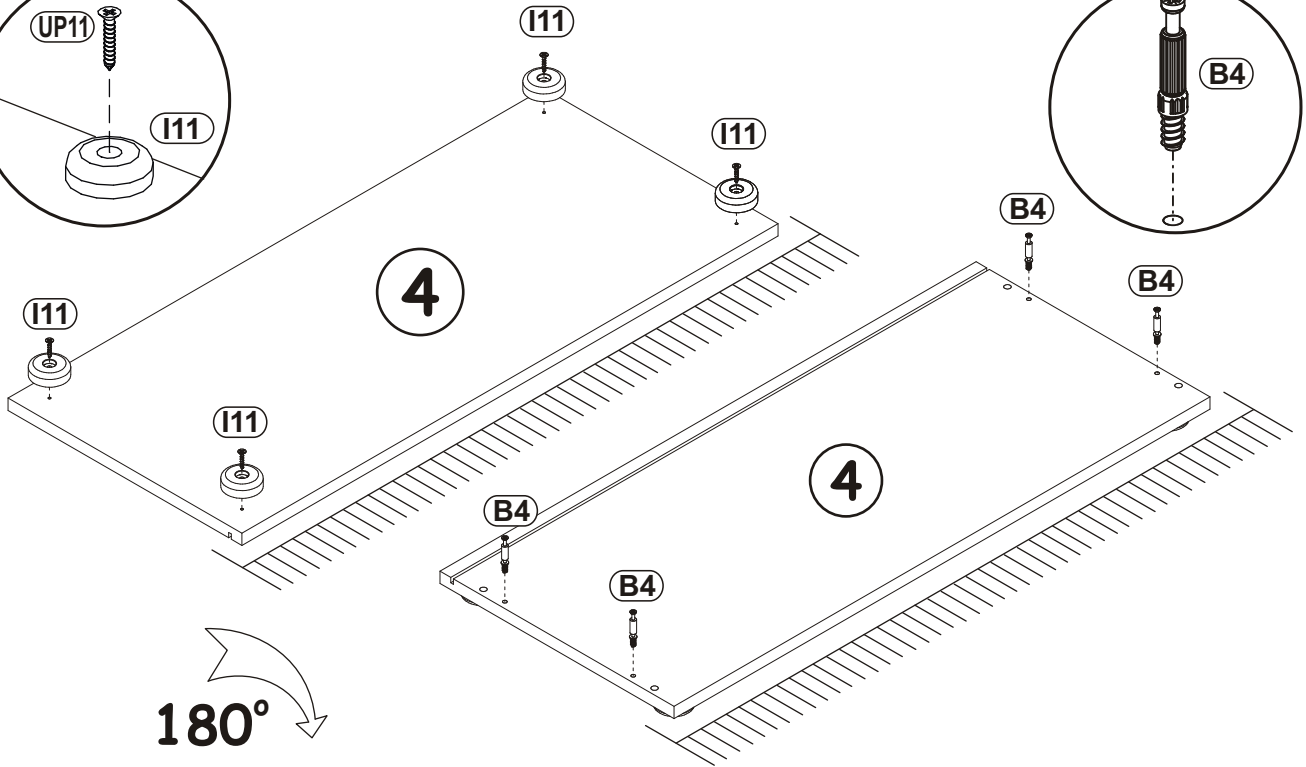
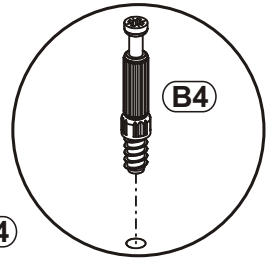
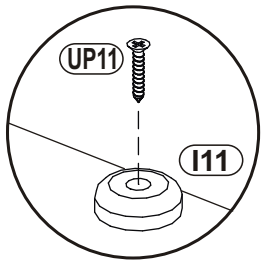

180°

4

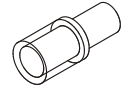
G20	
x2	

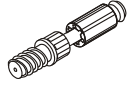
B4	
x4	

B5	
x2	Ø15x12

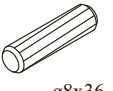
A1	
x2	Ø8x36

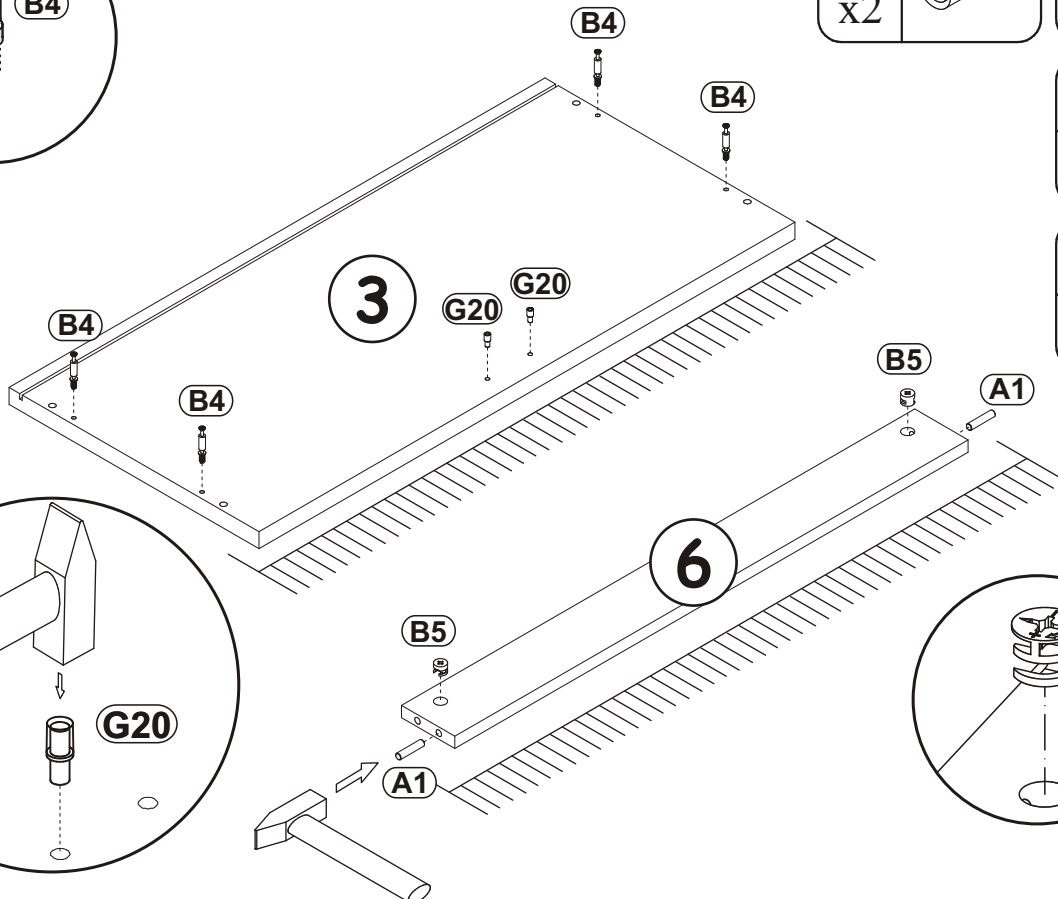
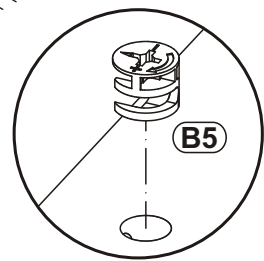
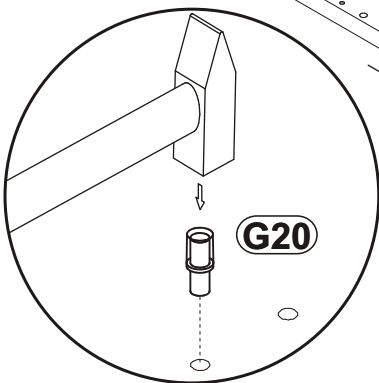
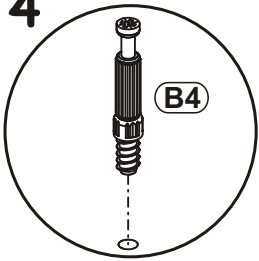

5

UP17	
x12	UPØ4x25

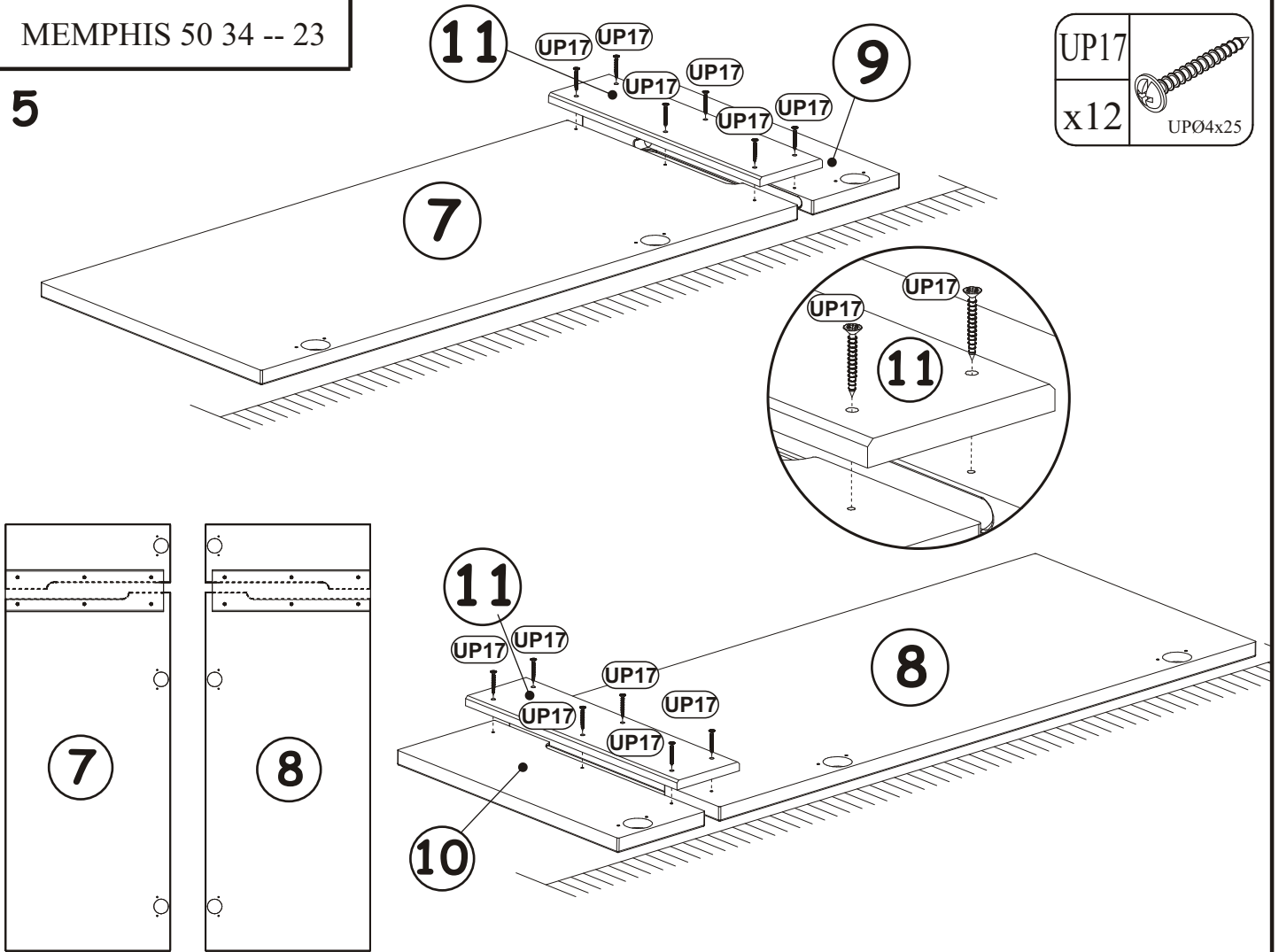

6

E7	Ø35
x6	H=0

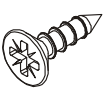
D10	
x12	USØ3,5x13

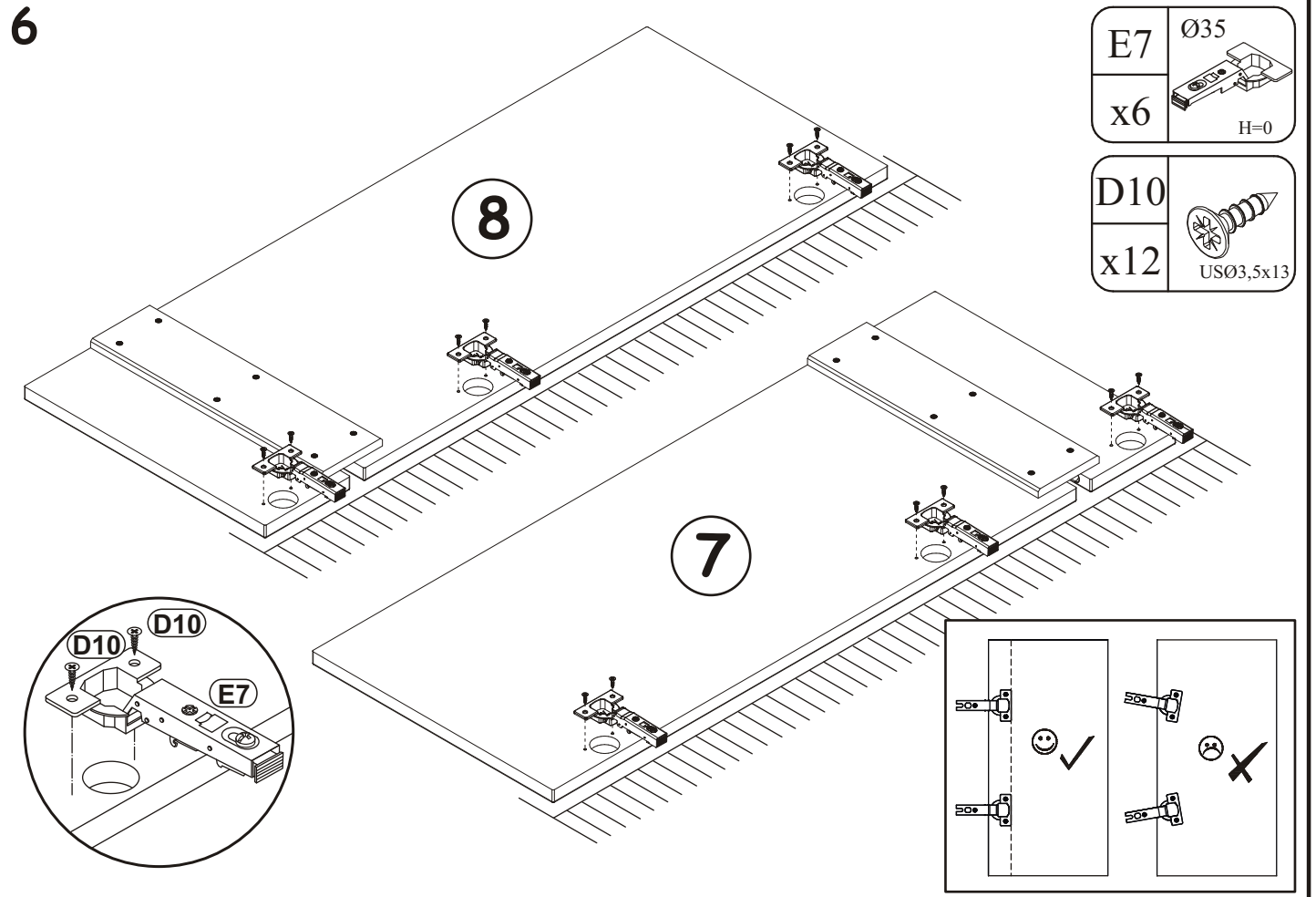

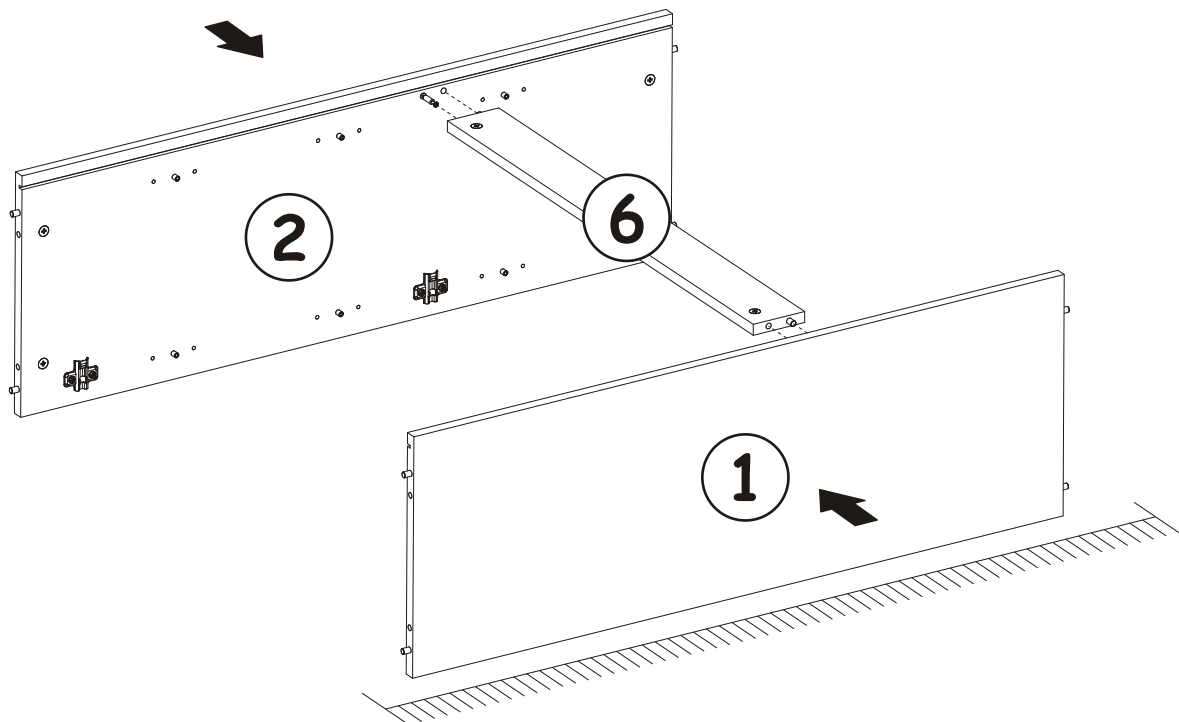

G5	
x2	

7

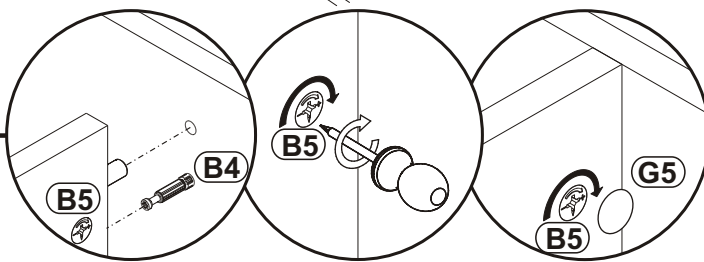

8



G5	
x4	

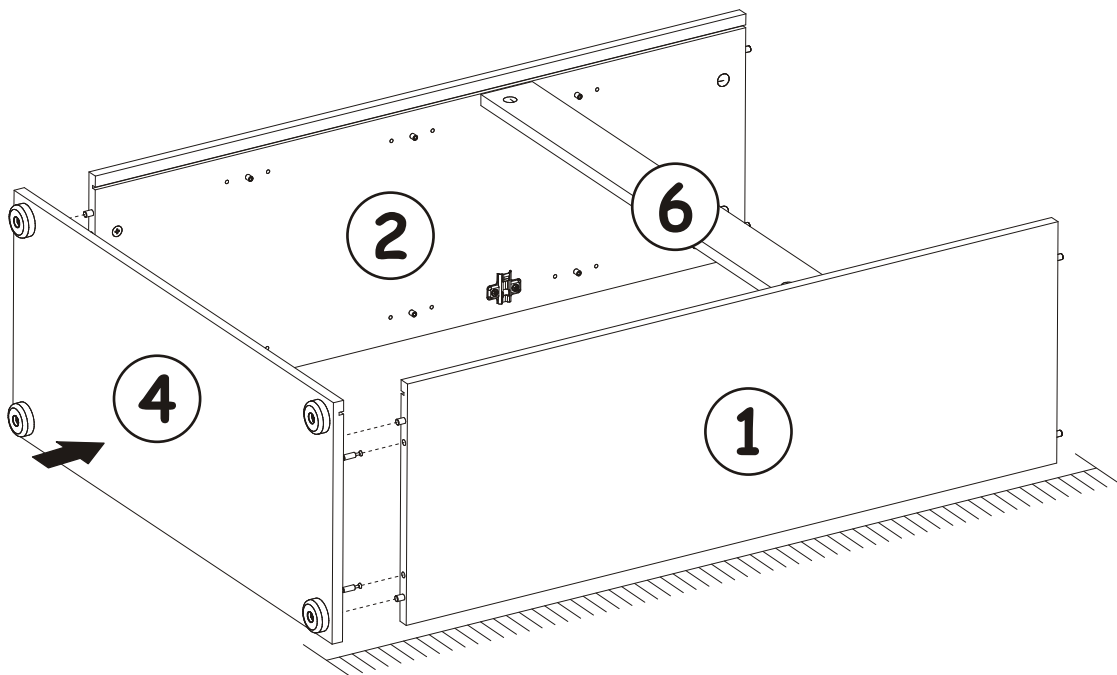



9

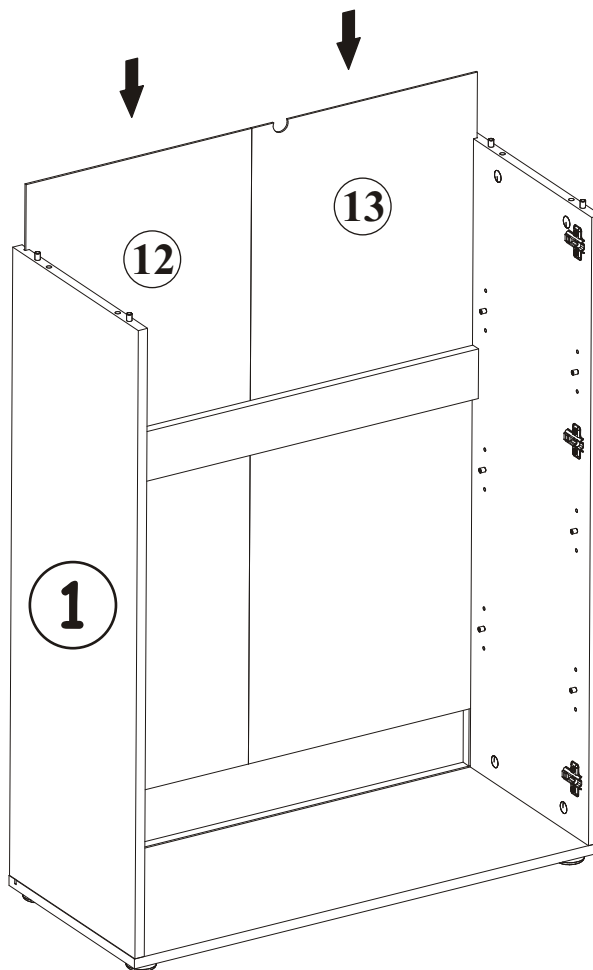

10

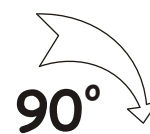
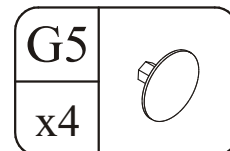
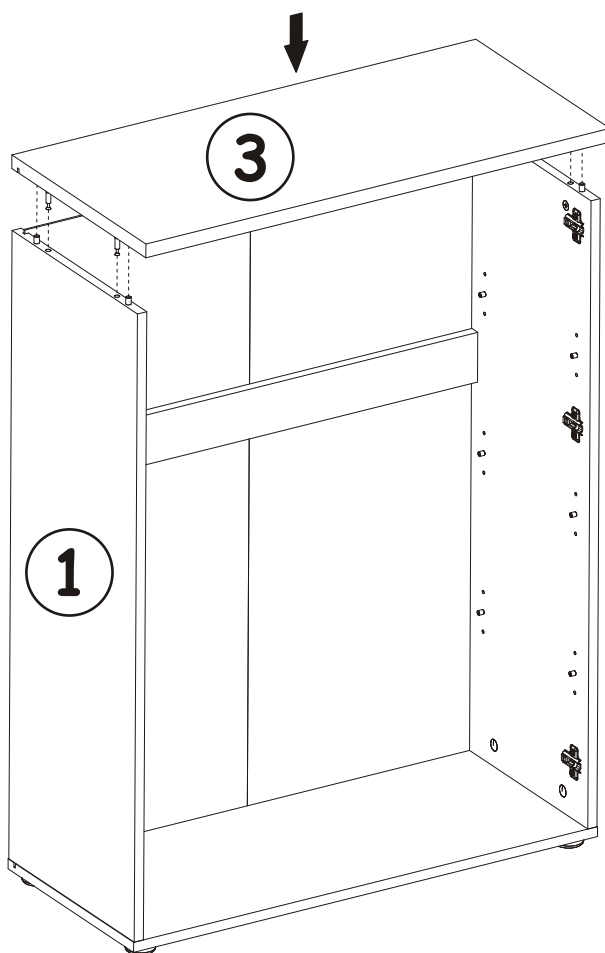
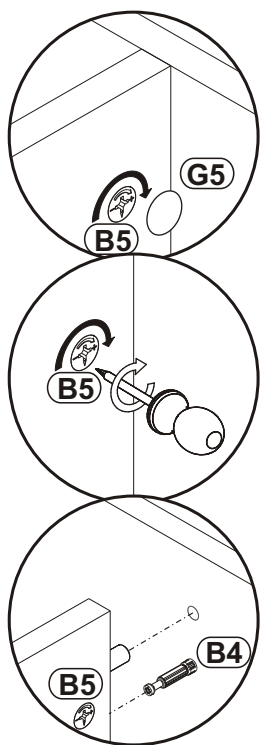

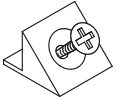

S1

x16

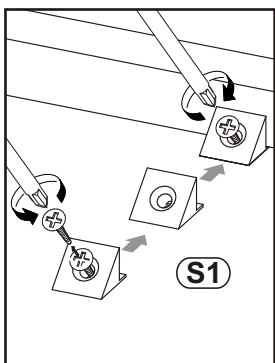
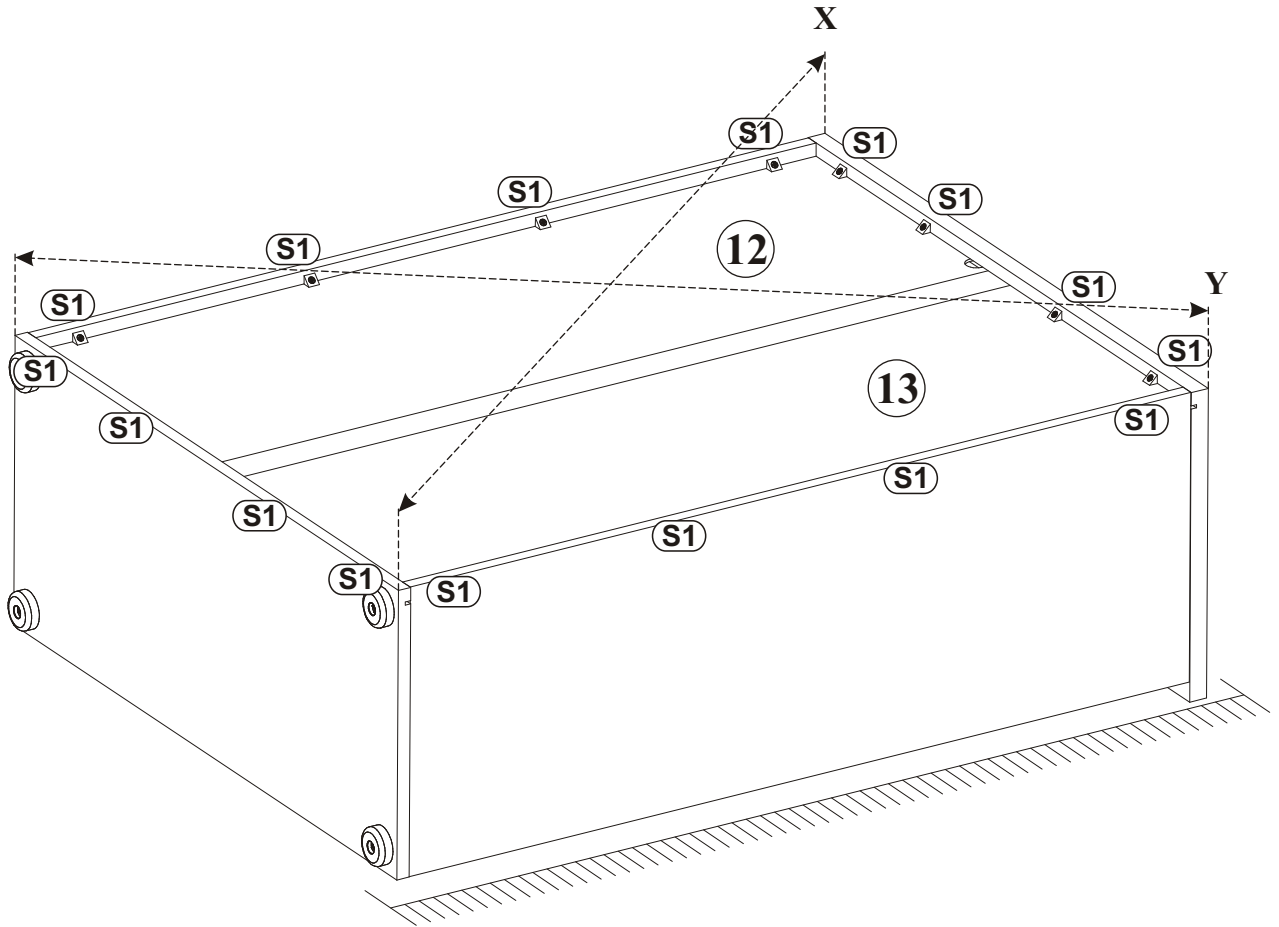
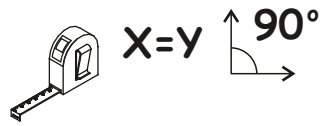

11

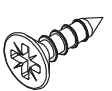
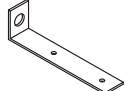

D10		L1		KR1	
x2	USØ3,5x13	x1		x1	

12

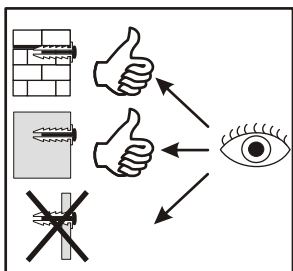
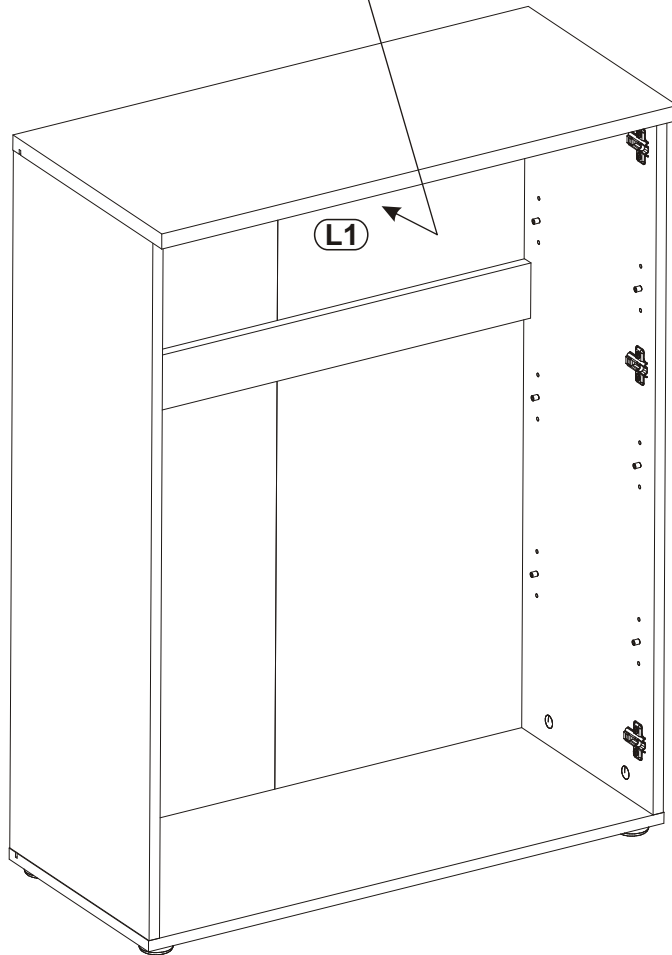
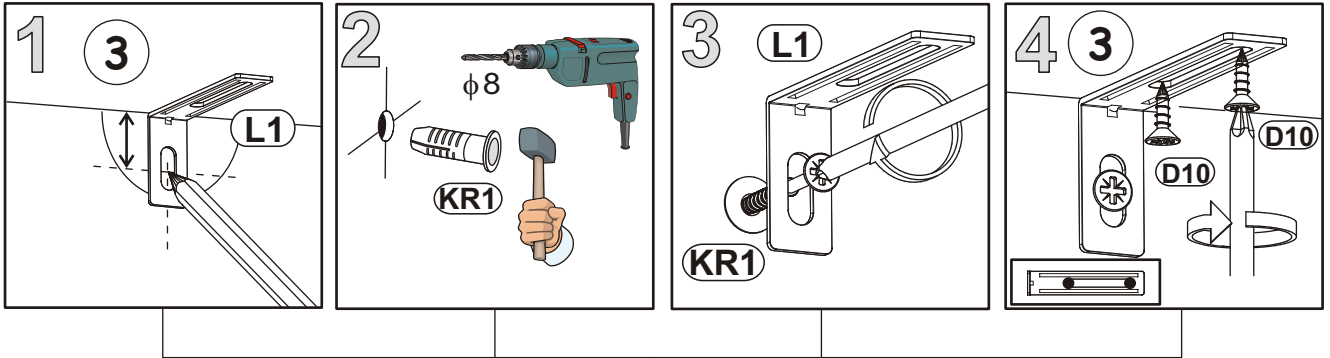

13

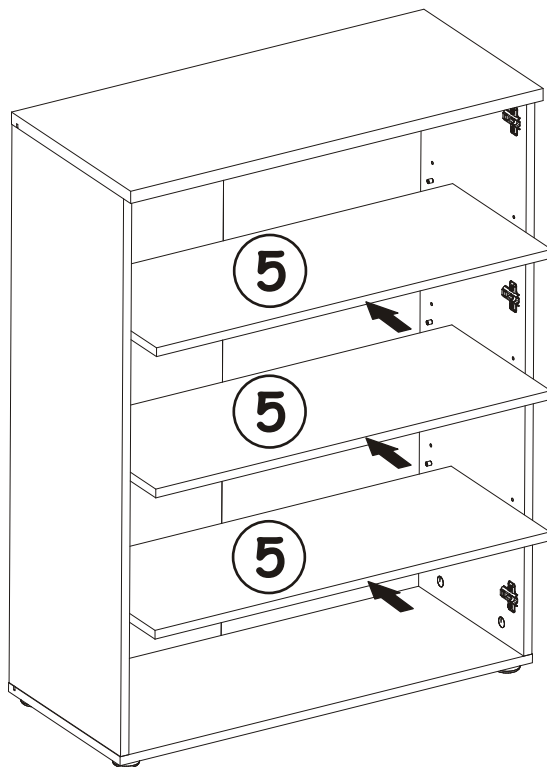

14

