

# MONTÁŽNÍ/MONTÁŽNY NÁVOD

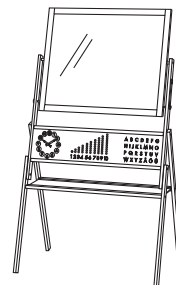
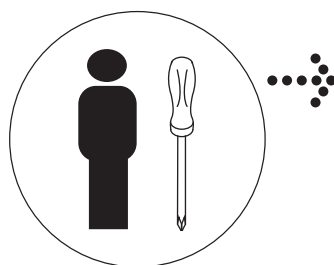

## 7019 Kindertafel . Child's blackboard

Aufbauanleitung . Assembly Instructions . Instruction d'assemblage . Instrucciones de montaje . Instruções de montagem . Istruzioni di montaggio . Opbouwhandleiding . Byggevejledning . Monteringsanvisning . Asennusohjeet . Montering Instruksjoner . Instrukcja montażu . Návod k sestavení . Szerelési útmutató . Skupština Upute . Instrucțiuni de asamblare . Uputstvo za sastavljanje . Montážny návod . Navodila za montažo . Montaj talimati . Οδηγίες Συναρμολόγησης . Руководство по сборке

- DE WICHTIG! - FÜR SPÄTERE VERWENDUNG AUFBEWAHREN - SORGFÄLTIG LESEN!
- UK ATTENTION! - PLEASE STORE FOR FURTHER ENQUIRIES! READ CAREFULLY!
- FR IMPORTANT! - CONSERVER POUR UNE UTILISATION ULTÉRIEURE - LIRE ATTENTIVEMENT!
- ES ¡ATENCIÓN! - GUARDAR PARA UN USO POSTERIOR. - LÉASE DETENIDAMENTE!
- PT IMPORTANTE! – GUARDAR PARA FUTURAS CONSULTAS – LER COM ATENÇÃO!
- IT IMPORTANTE! CONSERVARE PER L'USO FUTURO - LEGGERE CON ATTENZIONE!
- NL BELANGRIJK! - BEWAAR DE HANDLEIDING VOOR LATERE RAADPLEGING! ZORGVULDIG LEZEN!
- DK VIGTIGT! BØR OPBEVARES TIL SENERE BRUG - SKAL LÆSES GRUNDIGT!
- SE VIKTIGT! SPARAS FÖR FRAMTIDA BRUK - MÅSTE LÄSAS NOGA!
- FI TARKEAA! - SÄILYÄ MYÖHEMPÄÄ KAYTTÖÄ VARTEN – LUE TARKKAVAISESTI!
- NO VIKTIG! – OPPBEVARES FOR SENERE BRUK – MÅ LESES NØYE!
- PL WAŻNE! ZACHOWAĆ NA PRZYSZŁOŚĆ! STARANNIE PRZECZYTAĆ!
- CZ DŮLEŽITÉ! - NÁVOD SI USCHOVEJTE PRO POZDĚJŠÍ POUŽITÍ! - PEČLIVĚ SI JEJ PROČTĚTE!
- HU FONTOS! – KÉSŐBBI FELHASZNÁLÁSRA ŐRIZZE MEG – GONDOSAN OLVASSA EL!
- HR VAŽNO! - SAČUVATI ZA KASNIJU UPORABU – PAŽLJIVO PROČITATI!
- RO IMPORTANT! - PĂSTRĂȚI PENTRU UTILIZARE ULTERIOARĂ - CITIȚI CU ATENȚIE!
- RS VAŽNO! – ČUVATI ZA KASNIJU UPOTREBU – PAŽLJIVO SVE PROČITATI!
- SK DÔLEŽITÉ! - NÁVOD UCHOVAJTE NA NEŠKORŠIE POUŽITIE – DÔKLADNE SI HO PREČÍTAJTE!
- SI POMEMBNO! – SHRANITE ZA KASNEJŠO UPORABO – TEMELJITO PREBERITE!
- TR ÖNEMLİ!-DAHA SONRA KULLANILMAK ÜZERE DE MUHAFZA EDİNİZ– DİKKATLE OKUYUNUZ!
- GR ΣΗΜΑΝΤΙΚΟ! - ΝΑ ΦΥΛΑΣΣΕΤΑΙ ΓΙΑ ΑΡΓΟΤΕΡΗ ΧΡΗΣΗ - ΝΑ ΔΙΑΒΑΖΕΤΑΙ ΜΕ ΠΡΟΣΟΧΗ!
- RU ВАЖНО: ВНИМАТЕЛЬНО ПРОЧТИТЕ И СОХРАНИТЕ!





77500-01.11



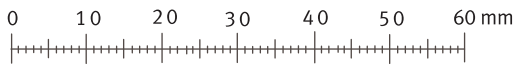

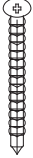
Service

Bei Rückfragen zu diesem Artikel bitte die folgende Kenn-Nummer und Art.-Nr. angeben:  
If you have any questions concerning this article use this identification number  
and item number:

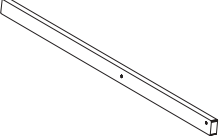
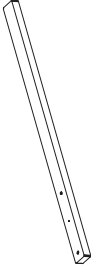
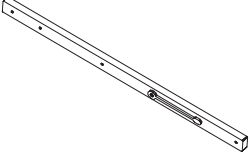
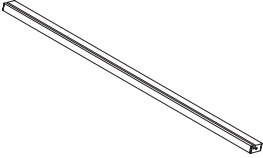
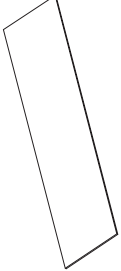
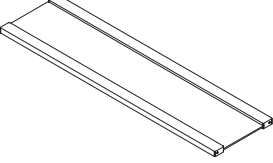
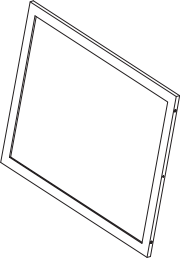
7019-



A	B	C	D	E			
4x	6x	6x	2x	2x			
							
1	2	3	4	5	6		
2x	2x	2x	1x	1x	1x		
							
7							
1x							
							

A	B	C	D	E
				
4x	6x	6x	2x	2x

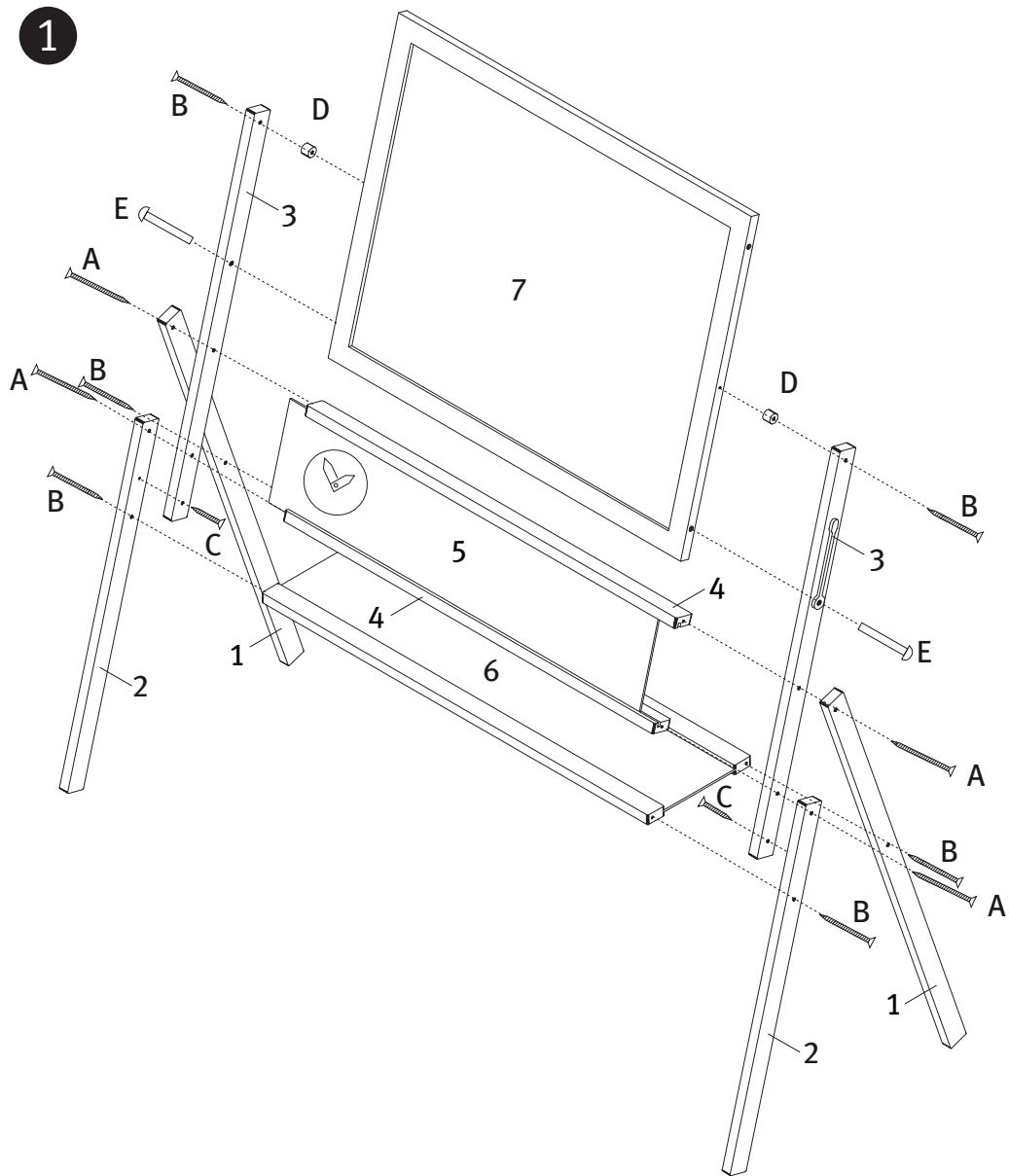



## Sicherheitshinweise

- Achtung: Achten Sie darauf, dass Ihr Kind das Produkt nur in seiner vorgegebenen Funktion gebraucht und nicht zweckentfremdet!
- Spielsachen müssen von Erwachsenen aufgebaut werden.



## Notes on safety

- Attention: Make sure that your child is using the device only in its given function!
- Toys must be assembled by an adult.



## Consignes de sécurité

- Attention: Veillez à ce que votre enfant n'utilise le produit que dans sa fonction prescrite et ne s'en serve pas à d'autres fins!
- Les jouets doivent être montés par des adultes.



## Instrucciones de seguridad

- ¡Atención: Asegúrese de que su hijo utilice el producto únicamente para la función prescrita y no para otros usos!
- Los juguetes deben ser montados por adultos.



## Instruções de segurança

- Atenção: Certifique-se de que a criança utiliza o produto apenas para a função a que se destina e não para outros fins!
- Os brinquedos devem ser montados por adultos.



## Informazioni di sicurezza

- Attenzione: Faccia attenzione al fatto che il Suo bambino utilizzi il prodotto esclusivamente per la sua funzione prevista e non lo impieghi per un altro scopo!
- I giocattoli devono essere montati da persone adulte.



## Veiligheidsinstructies

- Opgelet: Let op dat uw kind het product uitsluitend voor de vastgestelde functie gebruikt en niet aan het eigenlijke gebruik onttrekt!
- Speelgoed moet door volwassenen opgebouwd worden.



## Sikkerhedshenvisninger

- Giv agt: Vær opmærksom på, at dit barn kun bruger artiklen hensigtsmæssigt og ikke bruger den til andet end det oprindelige formål!
- Legetøj skal sammensættes af voksne.



## Säkerhetsinformation

- OBS: Se till, att ditt barn endast använder produkten ändamålsenligt och inte för något annat!
- Leksaker måste monteras av vuxna personer.



## Turvaohjeet

- Huomio: Varmista, että lapsesi käyttää tuotetta vain sille tarkoitettuun toimintaan, eikä käytä sitä muuhun tarkoitukseen!
- Aikuisten on koottava leikkikalut.



## Sikkerhetsanvisninger

- Gi akt: Du skal passe på at barnet ditt bruker skrivetavlen kun til det som det er bestemt for og ikke til noe annet!
- Leker skal monteres av voksne.



## Wskazówki bezpieczeństwa

- Uwaga: Należy uważać, aby dziecko stosowało produkt wyłącznie zgodnie z jego przeznaczeniem, a nie do innych celów!
- Zabawki muszą być montowane przez osoby dorosłe.



## Bezpečnostní pokyny

- Upozornění: Dbejte na to, aby dítě používalo výrobek jen k danému, nikoliv jinému účelu!
- Hračky musí smontovat dospělá osoba.



## Biztonsági előírások

- Figyelem: Ügyeljen rá, hogy a gyermeke csak az előre megadott célra használja a terméket, és másra ne fogja be!
- Játékokat felnőttek kell összeállítani.



## Sigurnosne upute

- Pozor: Obratite pozornost na to Vaše dijete proizvod koristi samo u svrhe za koje je namijenjen, a ne u druge svrhe!
- Igračke moraju sastaviti odrasle osobe.



## Indicații de securitate

- Atenție: Permiteți folosirea produsului de către copil numai în scopul pentru care este destinat și nu în alte scopuri!
- Jucăriile trebuie asamblate de adulți.



## Sigurnosne upute

- Pažnja: Vodite računa da vaše dete proizvod koristi samo u njegovoj predviđenoj funkciji, a ne suprotno nameni!
- Igračke moraju da sastave odrasli.



## Bezpečnostné upozornenia

- Pozor: Dbajte na to, aby dieťa výrobok používalo iba v súlade s jeho určením a nepoužívalo ho na iný účel!
- Hračky musia zmontovať dospelí.



## Varnostna navodila

- Pozor: Pazite na to, da bo otrok izdelek uporabljal le v skladu z njegovo namembnostjo in ne v druge namene!
- Igrače morajo sestaviti odrasli.



## Güvenlik uyarıları

- Dikkat: Çocukunuzun ürünü amacından saptırmadan, sadece belirtilen fonksiyonu dâhilinde kullanmasına dikkat ediniz! Oyun eşyalarının yetişkinler tarafından kurulmaları gerekmektedir.
- Oyuncaklar yetişkinler tarafından kurulmalıdır.



## Υποδείξεις ασφαλείας

- Προσοχή: Να μεριμνάτε, ώστε να χρησιμοποιεί το παιδί σας το προϊόν μόνο για τη λειτουργία που προβλέπεται κι όχι για άλλο σκοπό!
- Η συναρμολόγηση και ανέγερση των παιχνιδιών πρέπει να γίνεται από ενήλικους.



## Информация по технике безопасности

- Внимание! Следите за тем, чтобы детская кровать использовалась только по прямому назначению!
- Сборка игрушек должна производиться только взрослыми!