

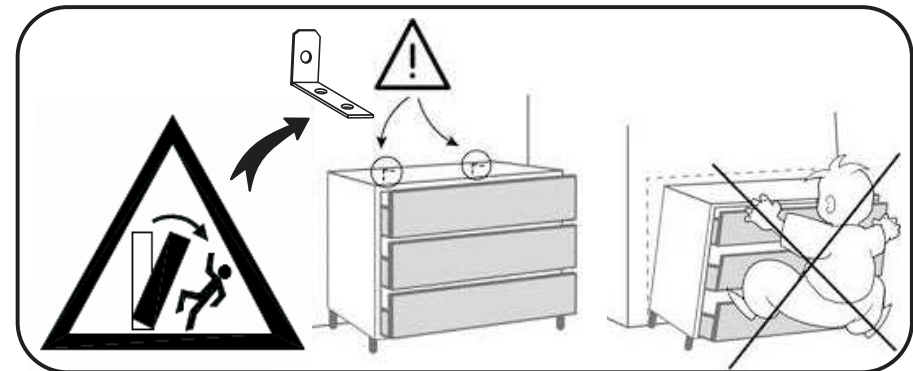

AMBROSINE

1 / 6

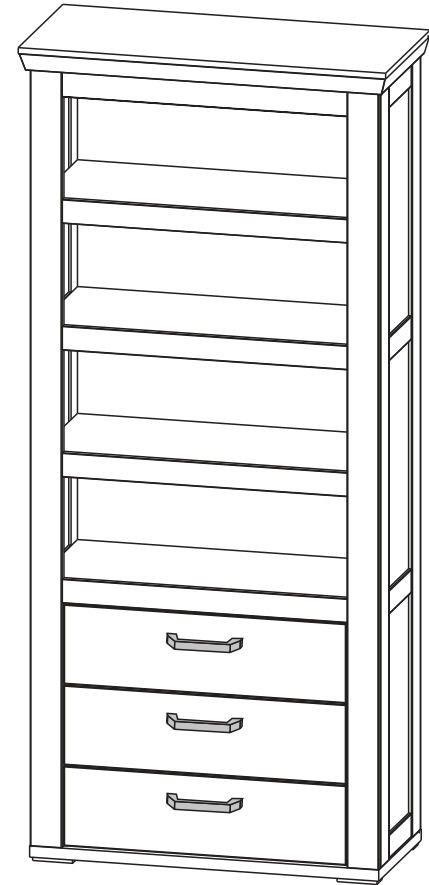

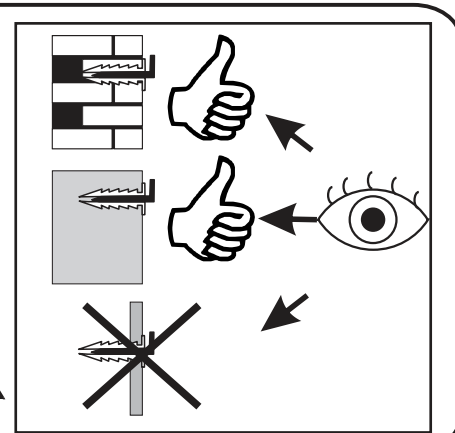
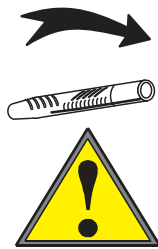
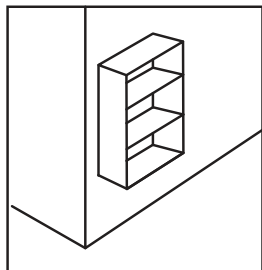
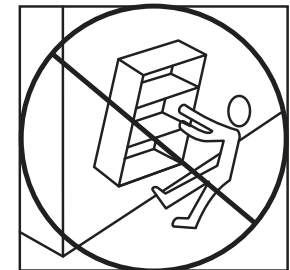
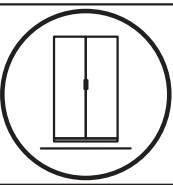
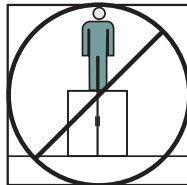
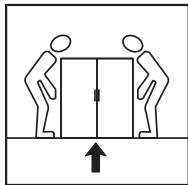
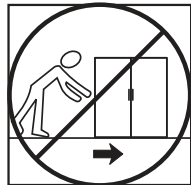
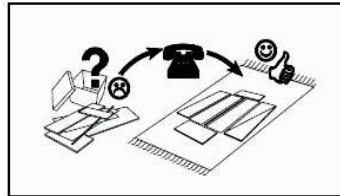
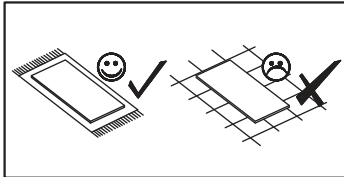
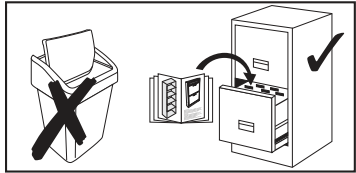
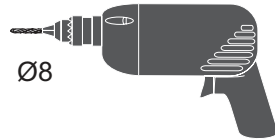
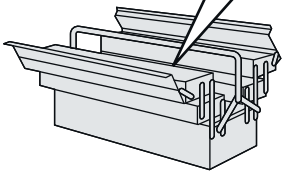
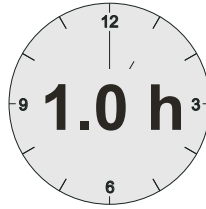
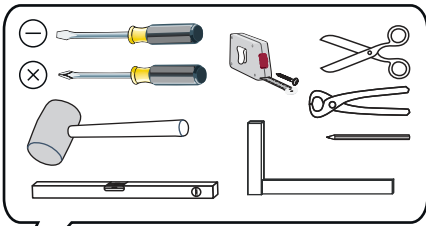
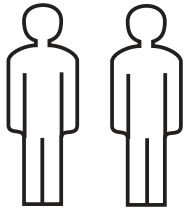
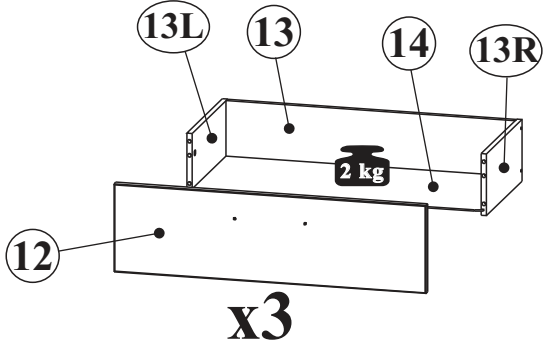
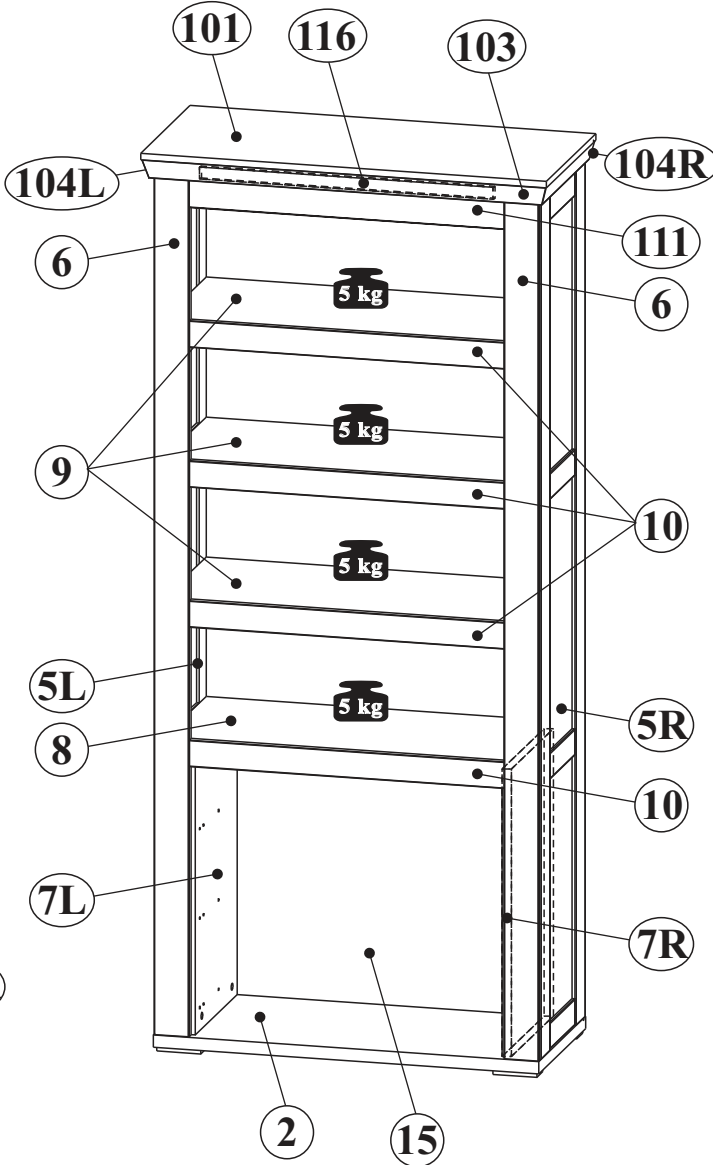
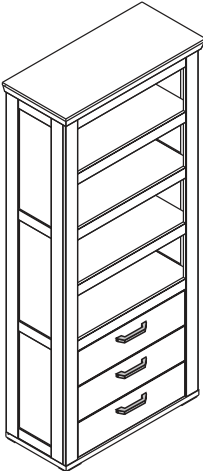



NR 1

C14  $\phi 20\text{mm}$ x4

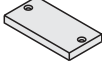
C141  $\phi 20\text{mm}$ x12

N25  x5

S10  3,5x25 x10

NR 2

U31  x3

A14  M4x22 x6

NR 3

J11  x2

P13  3,5x13 x4

T13  8x50 mm x2

T14  6x50 mm x2



1

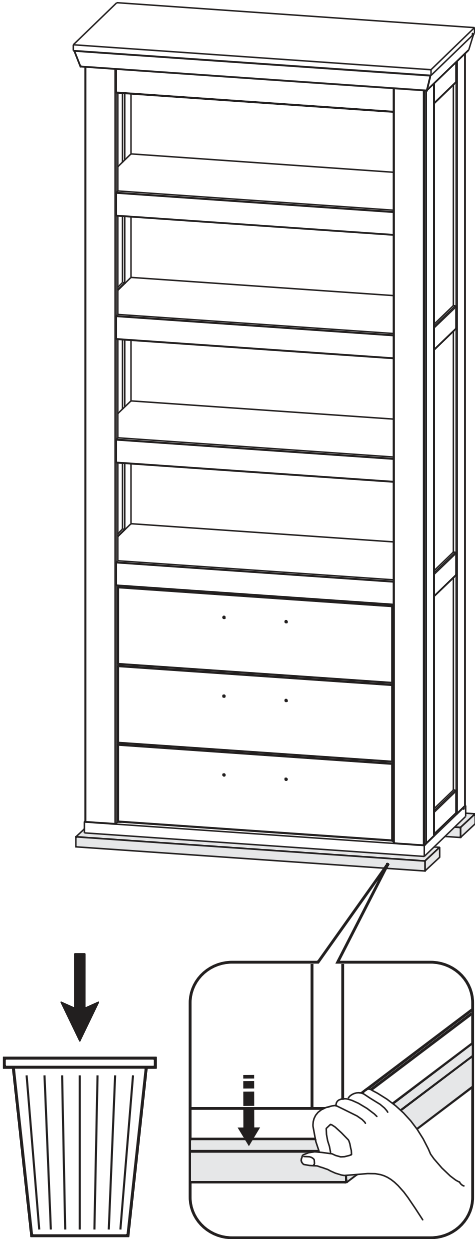

2

- S10** 3,5x25 x10
- N25** x5

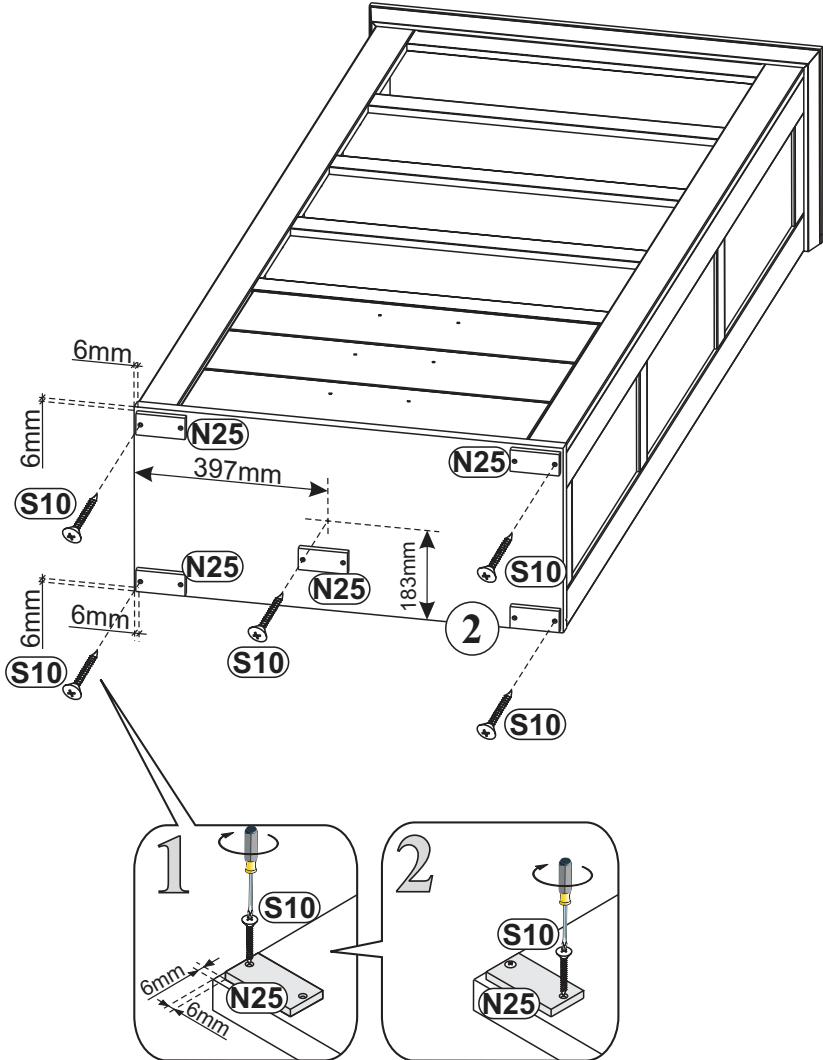

3

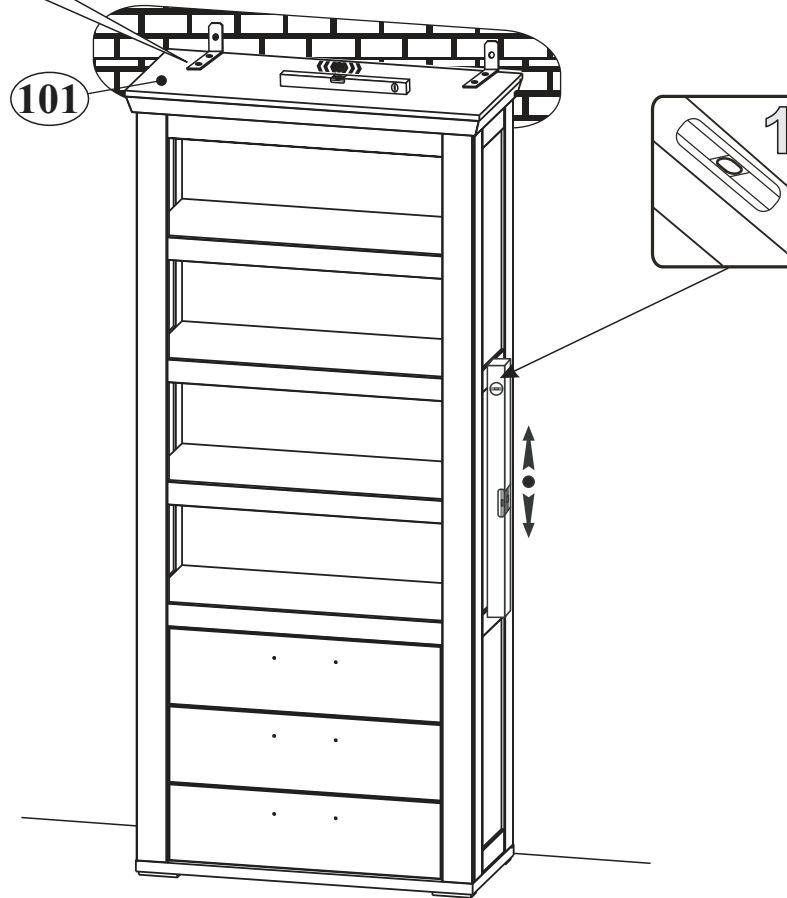
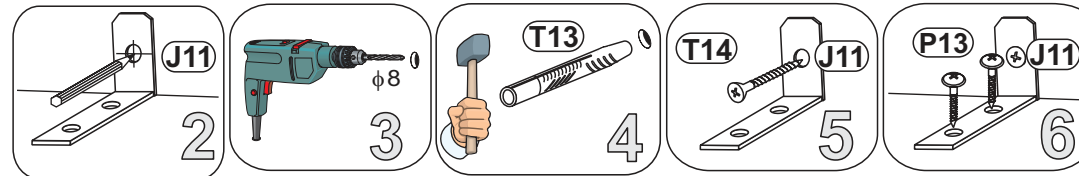
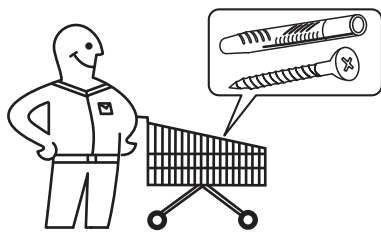
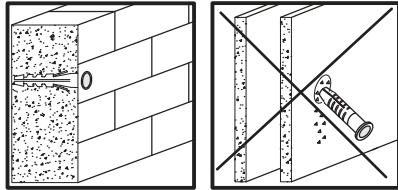
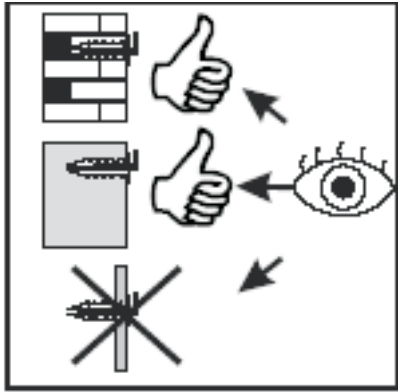

- J11** x2
- P13** 3,5x13 x4
- T13** 8x50 mm x2
- T14** 6x50 mm x2

4

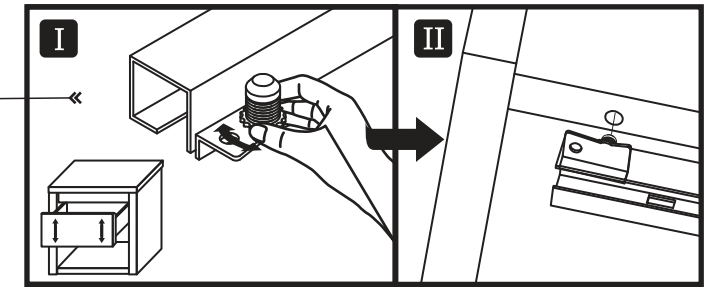
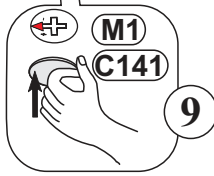
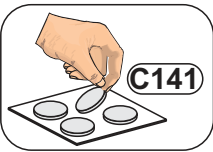
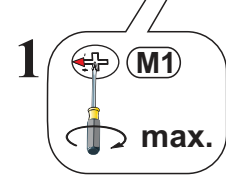
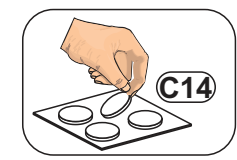
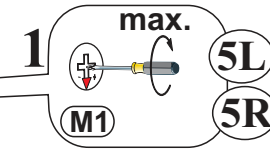
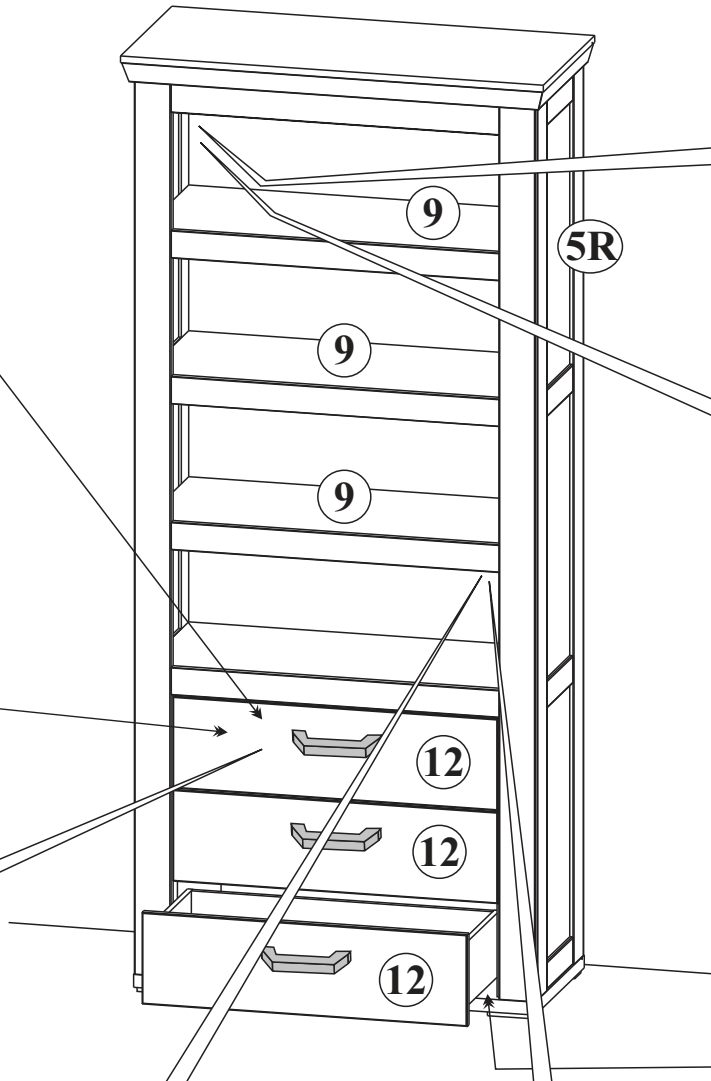
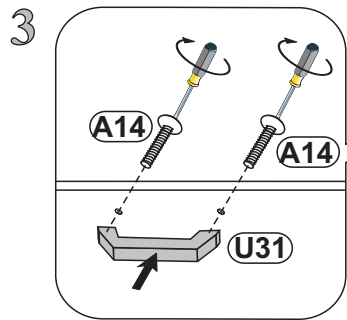
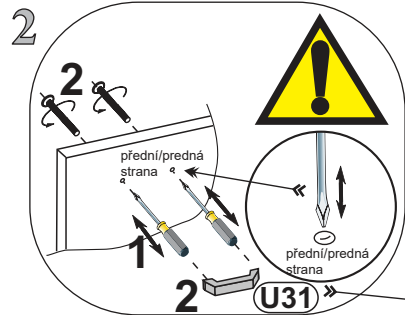
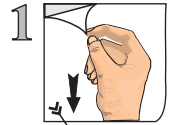
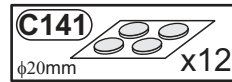
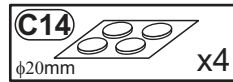
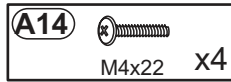
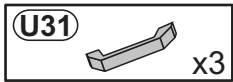

D CH AT LI LU	Kleinteile und Verpackungsfolien bei der Möbelmontage von Kindern fernhalten!
GB US	Keep small parts and plastic film out of the reach of children!
FR BE NC	Tenir les petites pièces et les films plastiques hors de la portée des enfants!
NL	Houd de kleine onderdelen en de plastic folie uit de buurt von kinderen!
IT	Tenere i componenti di piccole dimensioni e le pellicole di plastica fuori dalla portata dei bambini!
SI	Majhnih delov in embalažne folije pri montaži pohištva hranite izven dosega otrok!
XS HR BA	Male dijelove i foliju za pakovanje prilikom montaže namještaja držite dalje od djece
HU	Bútorszerelés közben a kis alkatrészek és a csomagoló fóliák gyermekektil távol tartandók!
BG	Дребни детайли и опаковъчни фолия да се държат далеч от деца при монтажа на мебелите!
CZ SK	Při montáži nábytku uchovávejte drobné díly a obalové fólie z dosahu dětí!
SE	Vid möbemontering ska smådelar och förpackningsfolien hållas oåtkomliga för barn!
RO	Țineți departe de copii piesele mici și folia de ambalat la montarea mobilei!
ES	¡Durante el montaje, mantenga alejados de los niños las piezas pequeñas y el material plástico de embalaje!
D CH AT LI LU	Möbelmontage muss auf ebenem Untergrund erfolgen. Bei Wandmontagen immer geeignetes Befestigungsmaterial verwenden.
GB US	Furniture must be assembled on a flat surface. For assembly to the wall only use suitable fixing materials.
FR BE NC	Le meuble doit être monté sur une surface plane. Pour le montage mural, utilisez des accessoires de fixation adaptés au type de mur.
NL	De meubels dienen op een vlakke ondergrond te worden gemonteerd. Voor wandmontage moeten geschikte bevestigingsmaterialen worden gebruikt.
IT	Il montage dei mobili deve avvenire su un fondo piano. Per il montaggio si prega di utilizzare solo materiali adatti.
SI	Pohištvo je treba montirati na ravni podlagi. Pri stenski montaži vedno uporabite pritrditveni material.
XS HR BA	Namještaj se mora montirati na ravnoj podlozi. Kod montaže na zid uvijek koristite prikladan materijal za pričvršćivanje.
HU	A bútorszerelését sik felületen kell végezni. Falra szereléshez mindig megfelelő rögzítianyagot kell használni.
BG	Монтажът на мебелите да се извършва на равна основа. При стenen монтаж винаги да се използва подходящ крепежен материал.
CZ SK	Montáž nábytku provádějte na rovném podkladu. Při montáži na stěnu používejte vždy vhodný přípevňovací materiál.
SE	Montering av möbeln måste göras på jämnt underlag. Vid väggmontering ska lämpligt uppfästningsmaterial användas.
RO	Montarea mobilei trebuie să se realizeze pe o pardoseală dreaptă. La montarea la perete utilizați întotdeauna material de fixare adecvat.
ES	El montaje debe efectuarse sobre una superficie uniforme. En el montaje mural emplee siempre el material de fijación adecuado.
D CH AT LI LU	Bitte beachten Sie die Montageanleitung. Halten Sie immer die angegebene Wattzahl ein. Verhindern Sie einen Hitzestau.
GB US	Please observe the assembly instructions. Do not exceed the max. given wattage. Ensure that the heat is not allowed to build up.
FR BE NC	Veillez respecter la notice de montage. Respectez impérativement le nombre des watts maximal. Veillez à éviter toute accumulation de chaleur.
NL	Lees a.u.b. de montagehandleiding door. Houd u beslist aan het max. opgegeven wattage. Zorg ervoor dat geen hittestuwing onstaat.
IT	Attenersi alle istruzioni di montaggio. Rispettarsi rigorosamente il numero di watt max. indicato. Assicurarsi che non si verifichi un accumulo di calore.
SI	Upoštevajte navodila za montažo. Vedno upoštevajte navedeno število vatov. Preprečite zastoj vročine.
XS HR BA	Obratite molimo Vas pozor na uputu za montažu. Uvijek se pridržavajte navedenog broja vati. Izbjegavajte zastoj vrućine.
HU	Vegye figyelembe a szerelési útmutatót. Mindig tartsa be a megadott wattszámot. Akadályozza meg a hirtelődést.
BG	Моля, вземете под внимание ръководството за монтаж. Спазвайте винаги посочените ватове. Избягвайте акумулиране на топлина.
CZ SK	Dodržujte prosím návod k montáži. Vždy dodržujte uvedenou hodnotu výkonu (watt). Zabráníte tak přehřívání.
SE	Följ monteringsanvisningen. Följ alltid angivet wattal. Undvik att hetta uppstår.
RO	Respectați instrucțiunile de montaj. Respectați întotdeauna numărul de wați impus. Evitați acumularea de căldură.
ES	Le rogamos que tenga presente las instrucciones de montaje. Respete siempre el número indicado de vatios. Evite la acumulación de calor.
D CH AT LI LU	Halten Sie die max. zulässigen Belastungswerte der Möbelteile ein. Details siehe Montageanleitung
GB US	Comply with the max. permissible loads. For details, please refer to the assembly instructions
FR BE NC	Respectez les valeurs de charge max. admissibles des parties de meubles. Pour plus de détails, cf. la notice de
NL	Houd de maximaal geoorloofde belastingswaarden van de meubeldelen aan. Voor details verwijzen wij naar de montagehandleiding
IT	Rispettare la portata max. permessa degli elementi del mobile. Per dettagli si vedano le istruzioni di montaggio e si vada
SI	Upoštevajte največjo dovoljeno obremenitev delov pohištva. Podrobnosti najdete v navodilih za montažo in na
XS HR BA	Pridržavajte se maks. Dozvoljenih vrijednosti opterećenja elemenata namještaja. Detalje vidi u uputu za montažu
HU	Tartsa be a bútorelemek max. megengedett terhelési értékeit. A részleteket lásd a szerelési útmutatóban
BG	Спазвайте макс. допустимите стойности на натоварване на мебелите. За подробности виж ръководството за монтаж
CZ SK	Dodržujte max. přípustné hodnoty zatížení nábytkových dílů. Podrobnosti viz návod k montáži
SE	Följ max. tillåten belastning av möbeldelarna. Mer information finns i monteringsanvisningen
RO	Respectați valorile de solicitare max. admise pentru corpurile de mobilier. Pentru detalii consultați instrucțiunile de montaj
ES	Respete los valores máximos de carga admisibles para las piezas de los muebles. Consulte los detalles en las instrucciones
D CH AT LI LU	Zur Möbelreinigung ein mit Wasser befeuchtetes, fusselfreies Baumwolltuch verwenden. Gereinigte Flächen immer trockenreiben!
GB US	To clean the furniture only use a water dampened lint-free cotton cloth. Once cleaned, always wipe the surfaces dry.
FR BE NC	Utilisez un chiffon en coton non pelucheux humidifié avec de l'eau pour nettoyer les meubles. Séchez systématiquement les surfaces nettoyées en les frottant !
NL	Gebruik een met water bevochtigde, pluivrije katoenen doek om de meubels te reinigen. Wrijf gereinigde oppervlakken altijd droog!
IT	Per pulire il mobile utilizzare un panno di cotone inumidito d'acqua e che non perde pelucchi. Asciugare sempre le superfici che si sono pulite!
SI	Za čiščenje pohištva uporabljajte vlažno bombažno krpo, ki ne pušča vlaken. Očiščene površine vedno obrišite do suhega!
XS HR BA	Za čišćenje namještaja koristite sa vodom navlaženu pamučnu krpu koja ne ispušta vlakna. Očiščene površine uvijek obrišite suhom krpom!
HU	Bútortisztításhoz vízzel benedvesített, nem szálazódó pamutkendit használjon. A megtisztított felületeket mindig törölje szárazra!
BG	За почистване на мебелите използвайте навлажнена с вода, неизпускаща влакна памучна кърпа. Почистените повърхности винаги да се изтриват до сухо!
CZ SK	K čištění nábytku používejte bavlněný hadr neuvolňující vlákna, navlhčený ve vodě. Vyčištěné plochy vždy utřete do sucha!
SE	För möbelförrensning används en luddfri bomullsduk fuktad med vatten. Rengjorda ytor ska alltid torkas torra!
RO	Pentru curățarea mobilei utilizați o lavetă din bumbac fără scame umezită cu apă. Suprafețele curățați se șterg întotdeauna până se usucă!
ES	Emplee un paño de algodón humedecido con agua y libre de pelusa para la limpieza de los muebles. ¡Seque siempre las superficies que ha limpiado!