

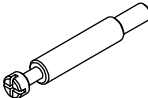

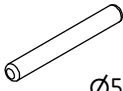







111	10		193	4	 Ø5 x 40 mm	351	8	 3,5 x 15 mm
120	10		204	2		377	8	 4 x 25 mm
150	4		215	4		408	4	 M4 x 9 mm
152	4		220	18		503	4	
182	16		305	8	 6,3 x 9 mm			
190	20	 Ø8 x 30 mm	320	2	 6 x 50 mm			

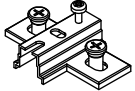
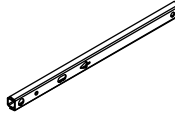

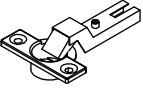

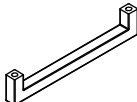

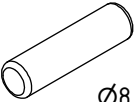
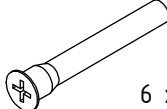
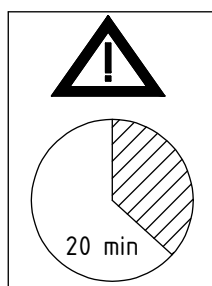
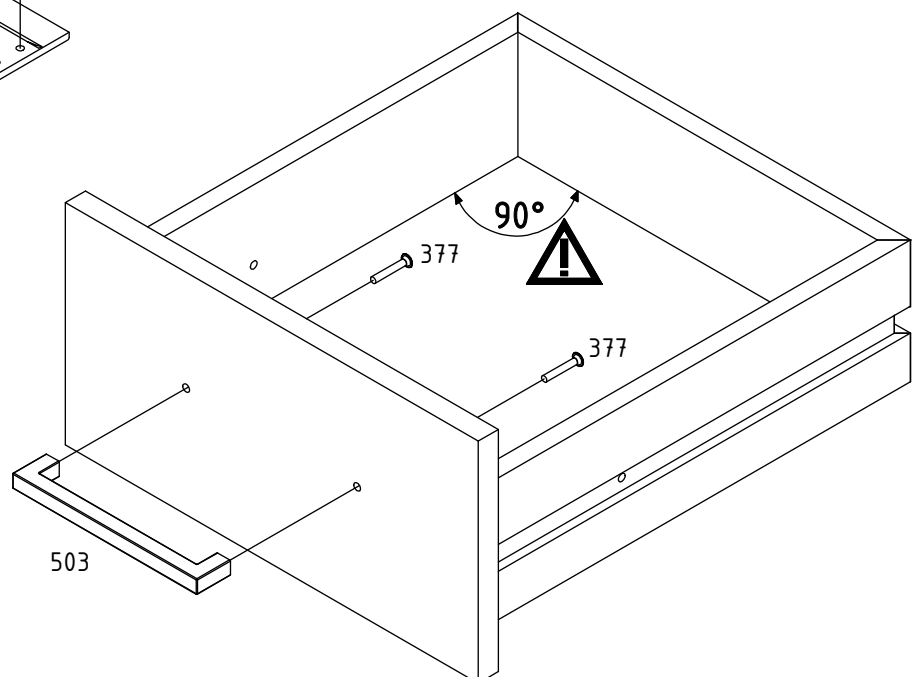
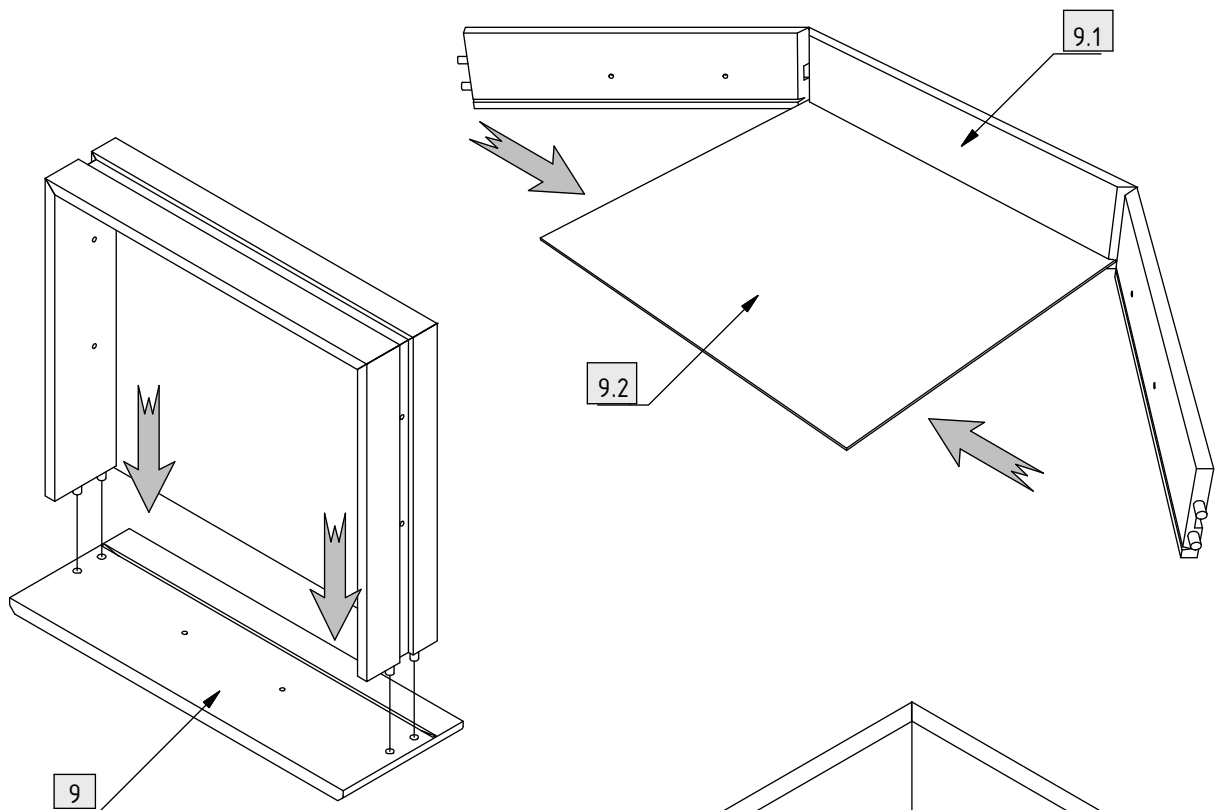
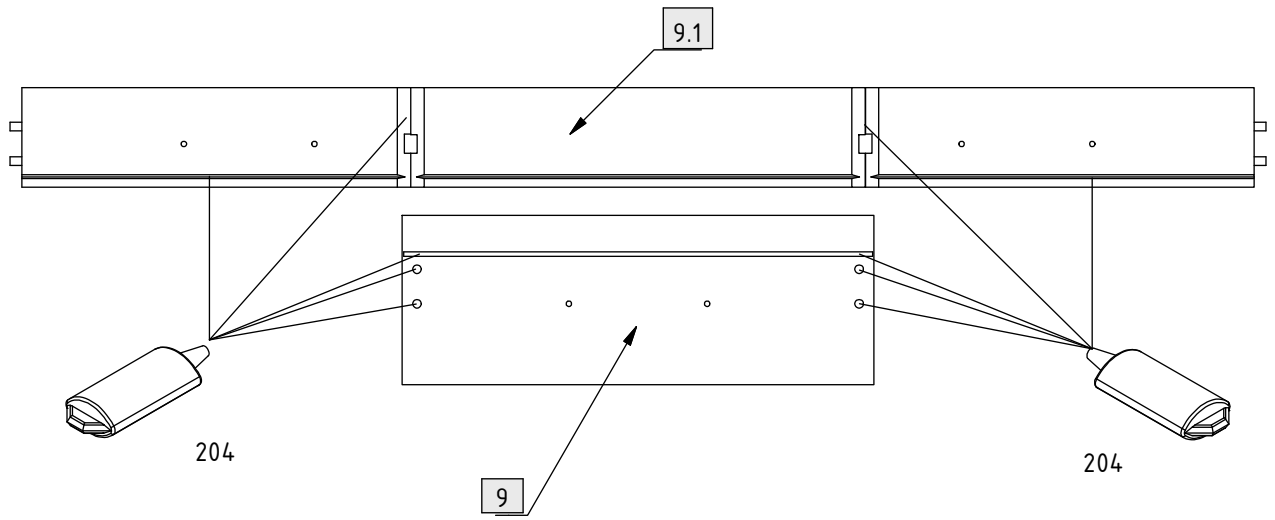
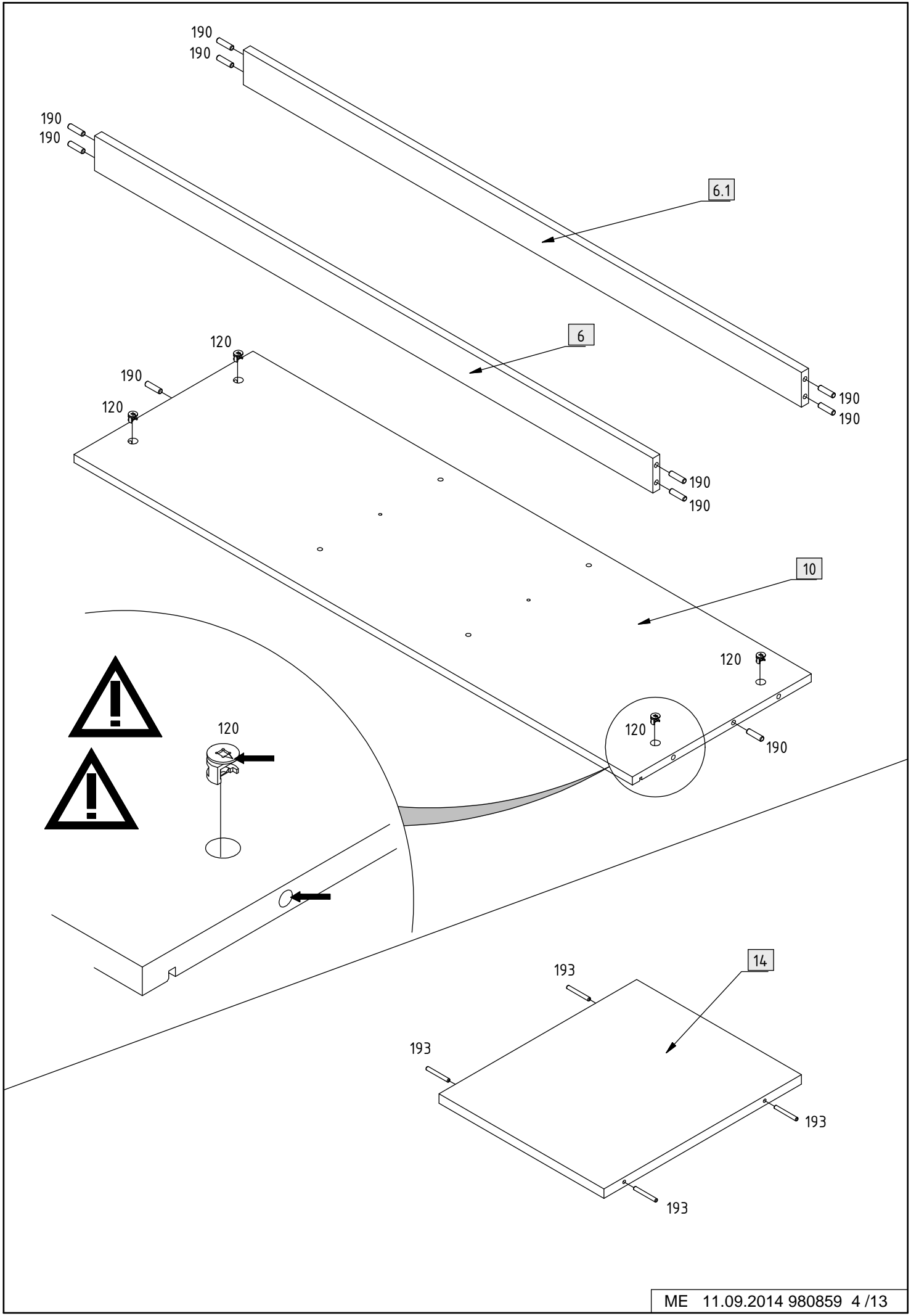
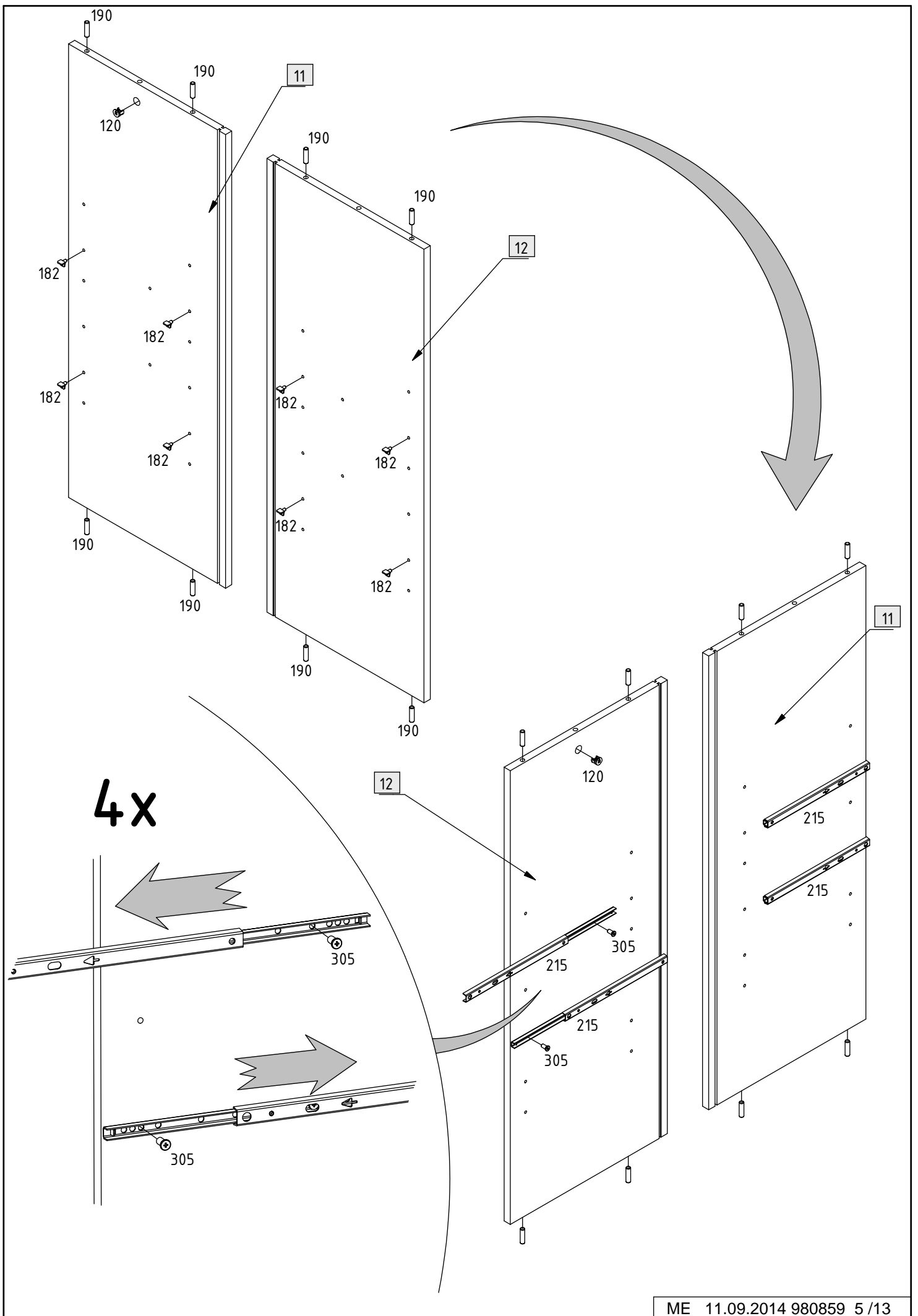
2

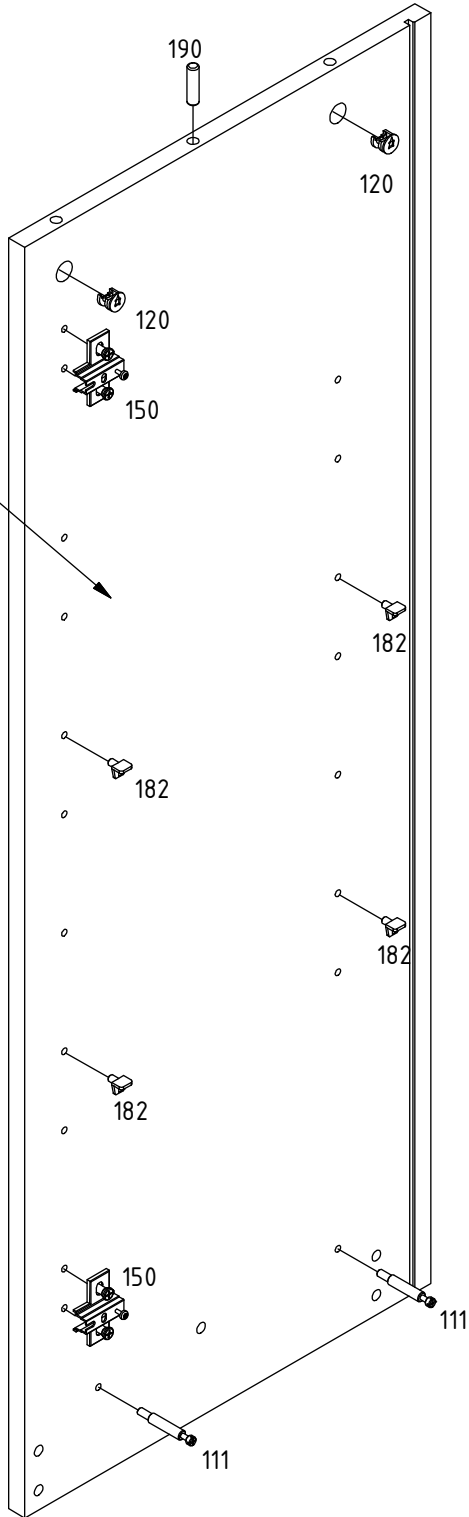

3

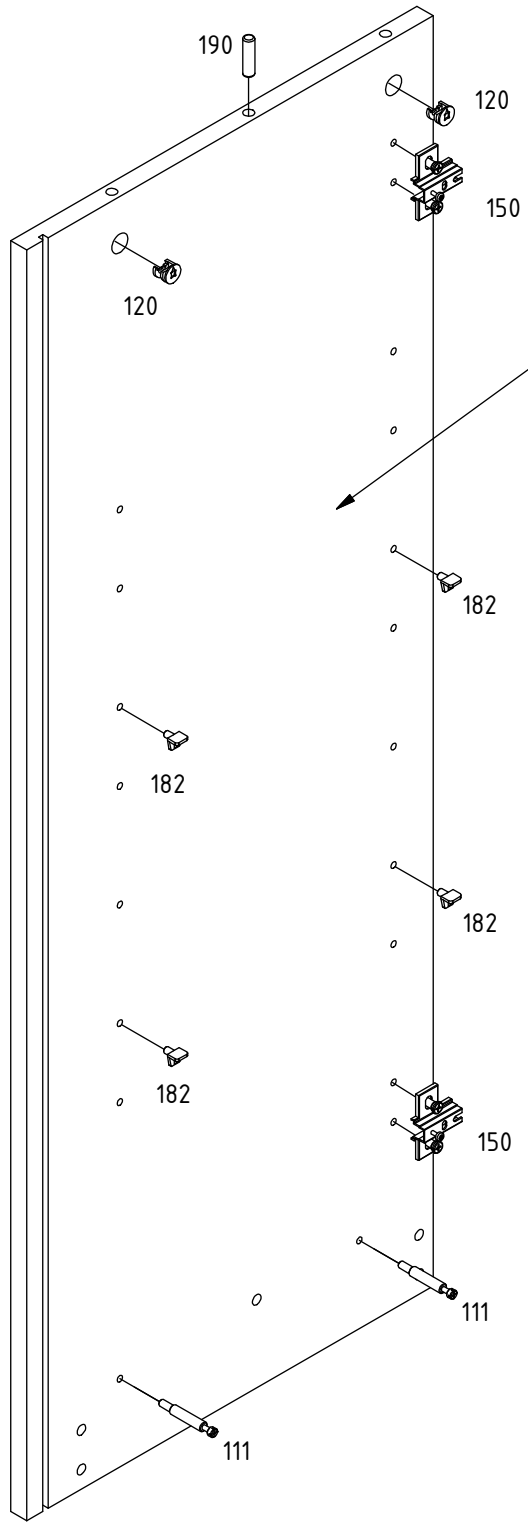

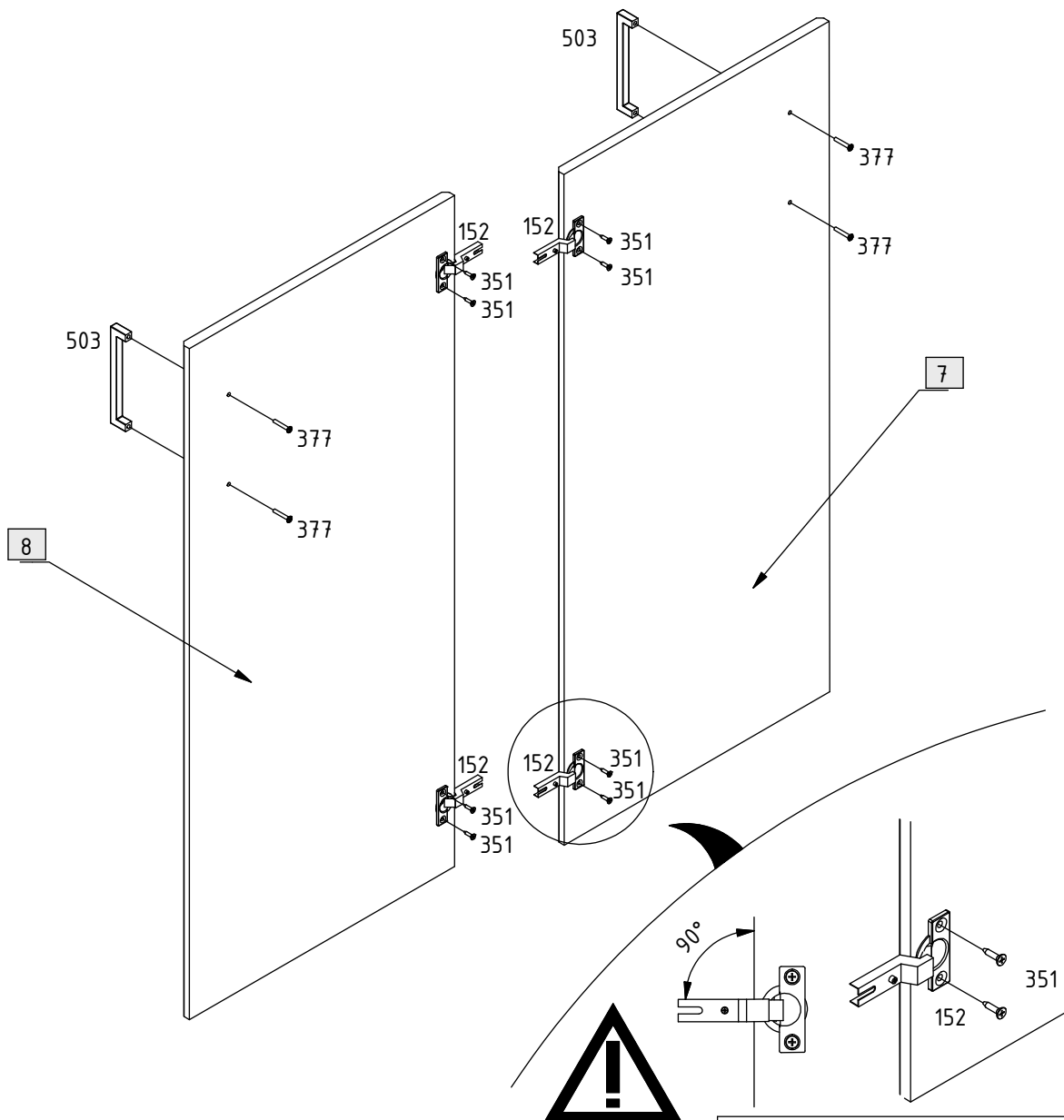
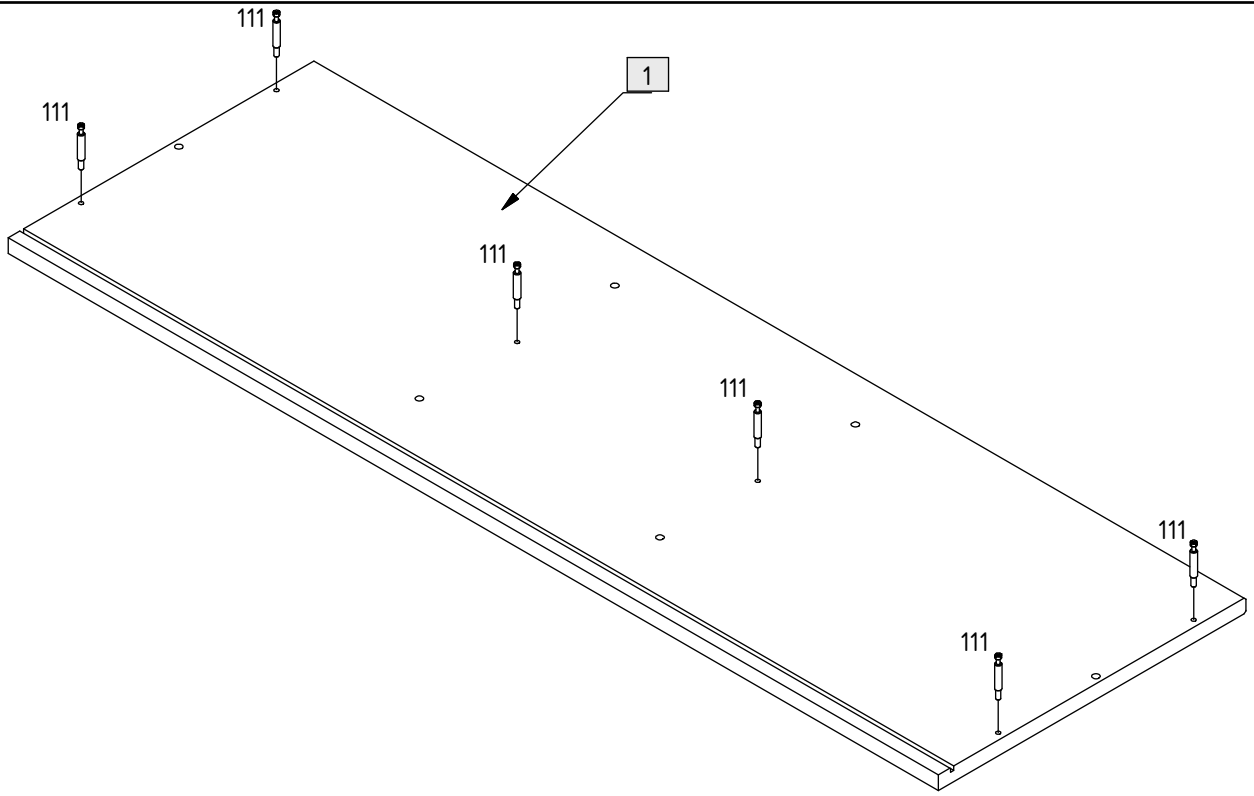

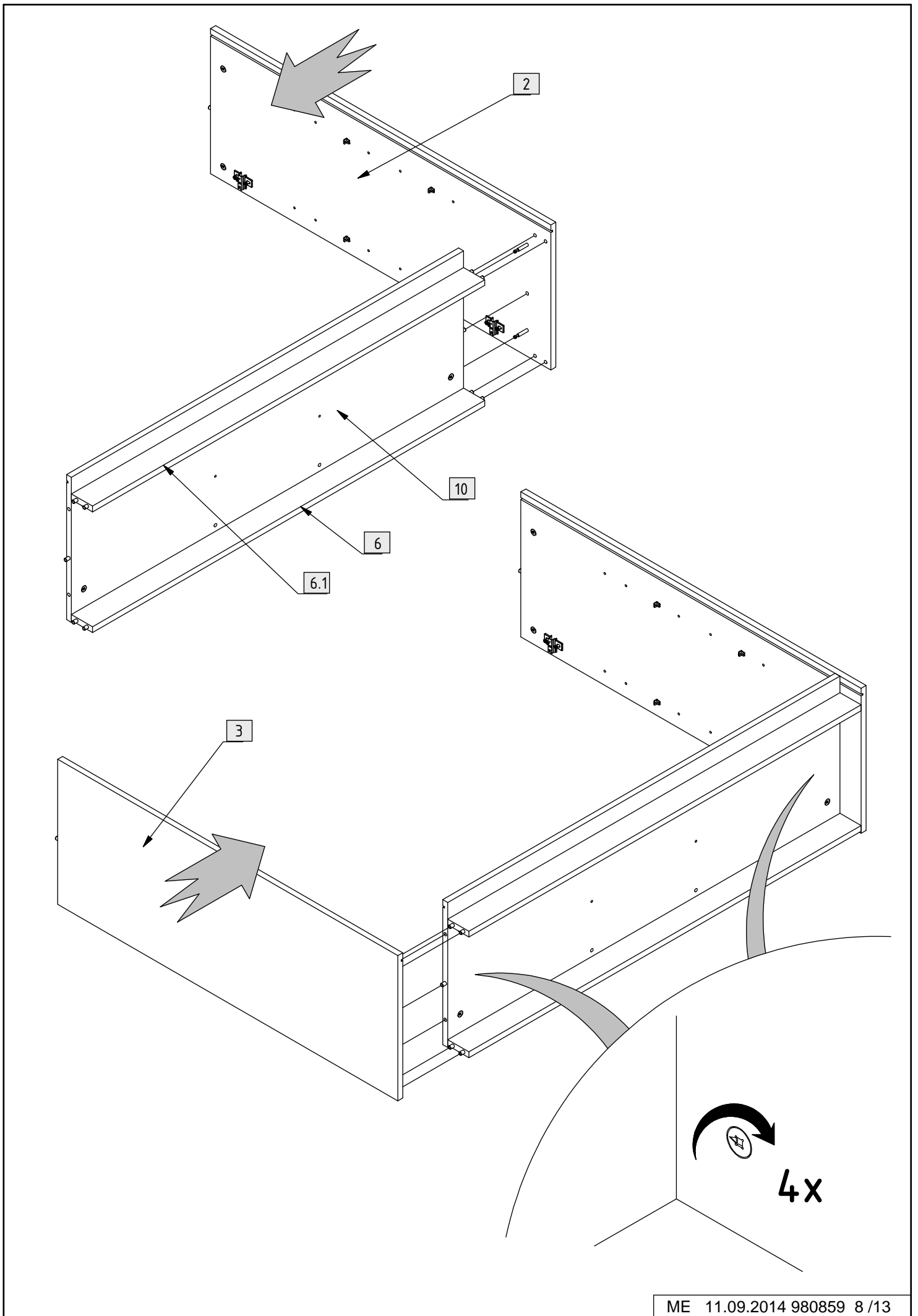



1.

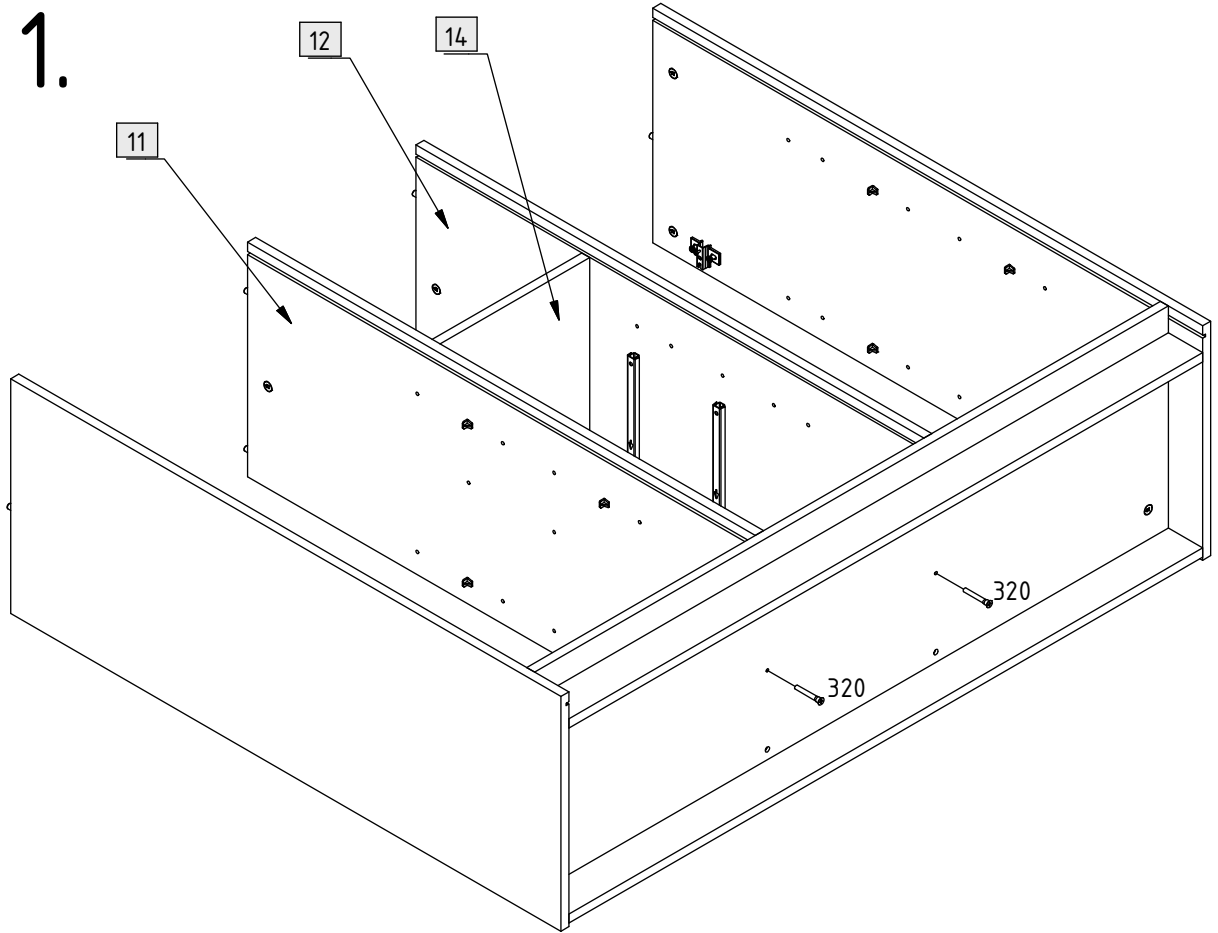

2.

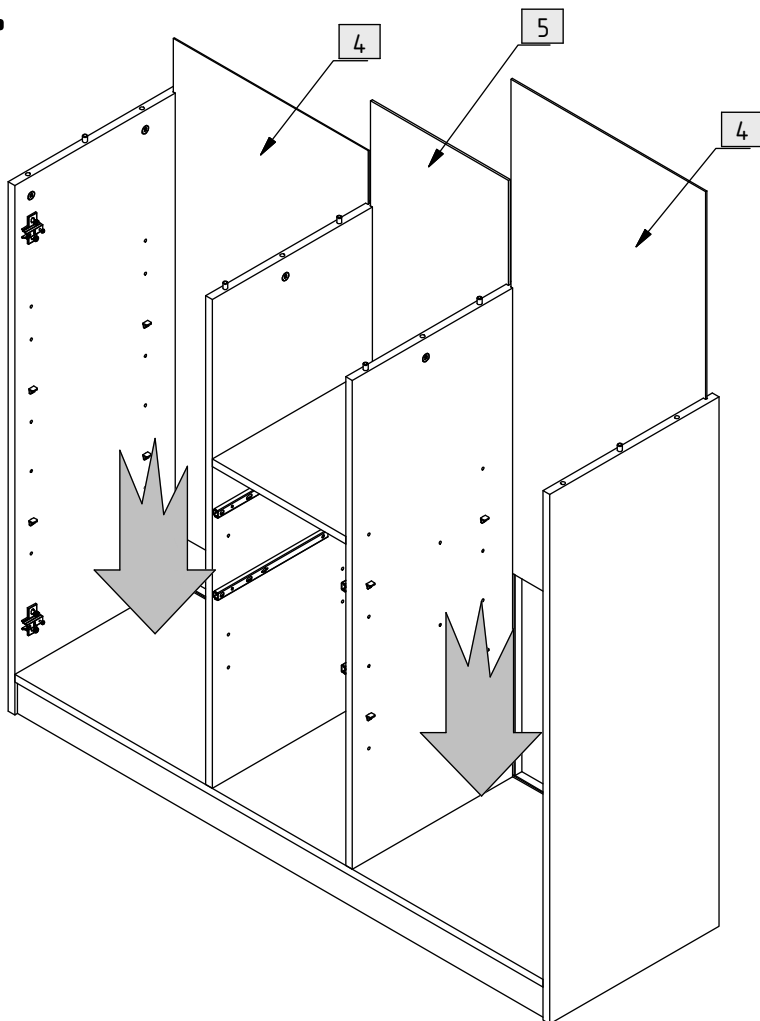

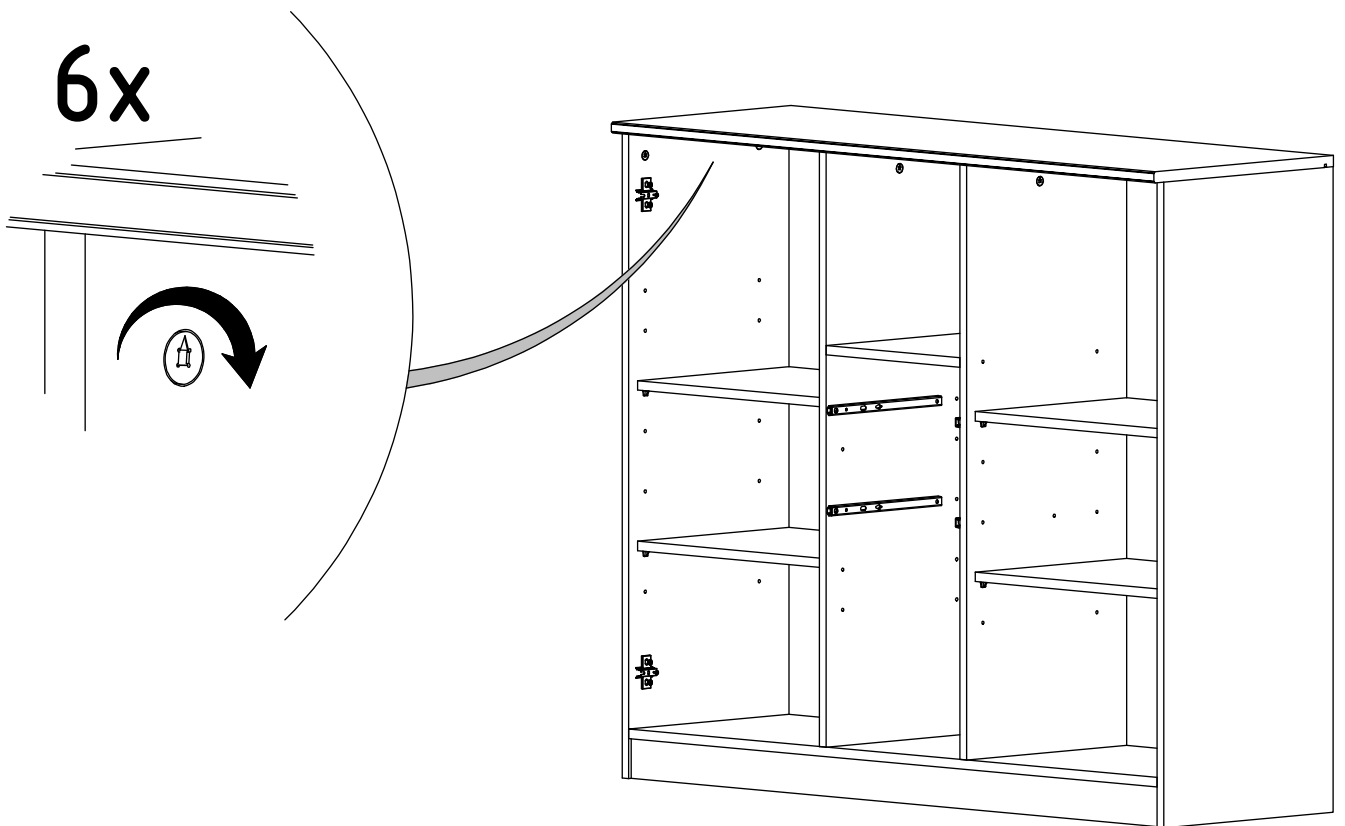
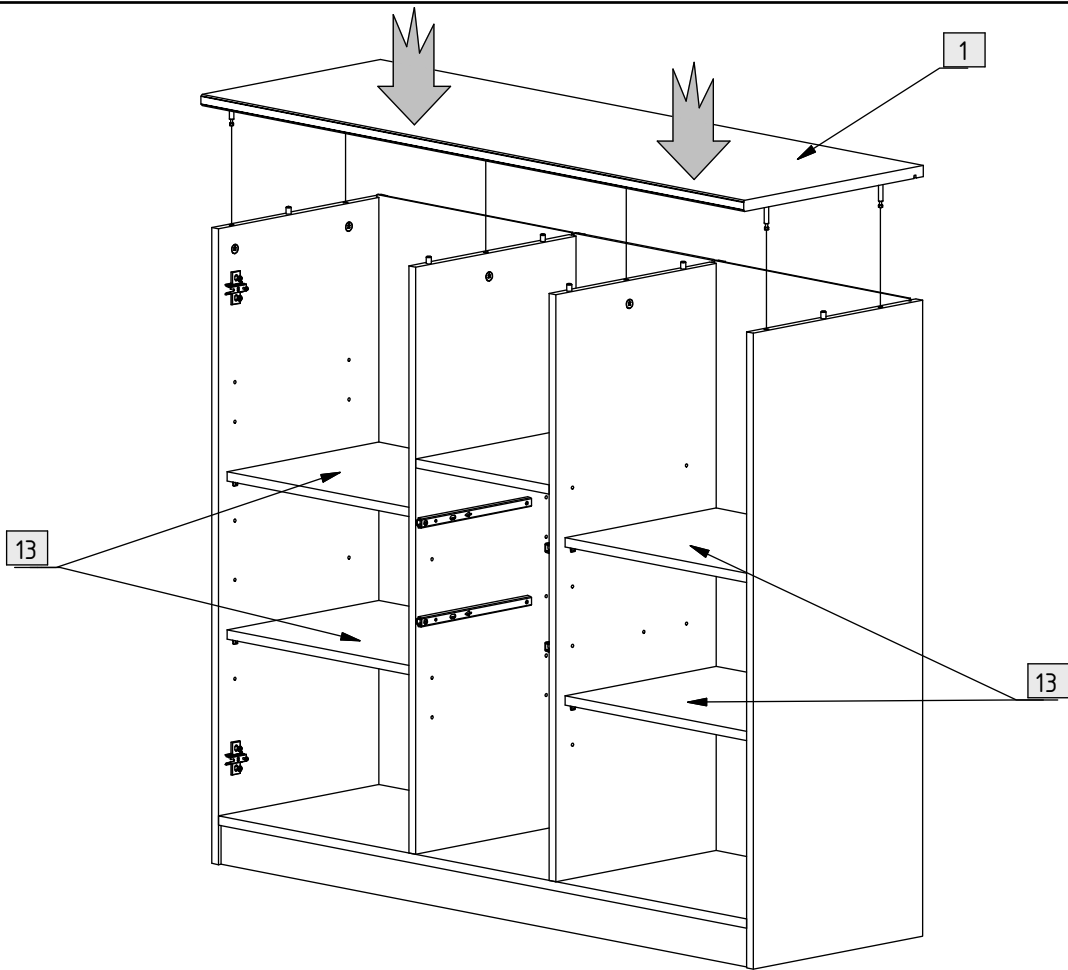

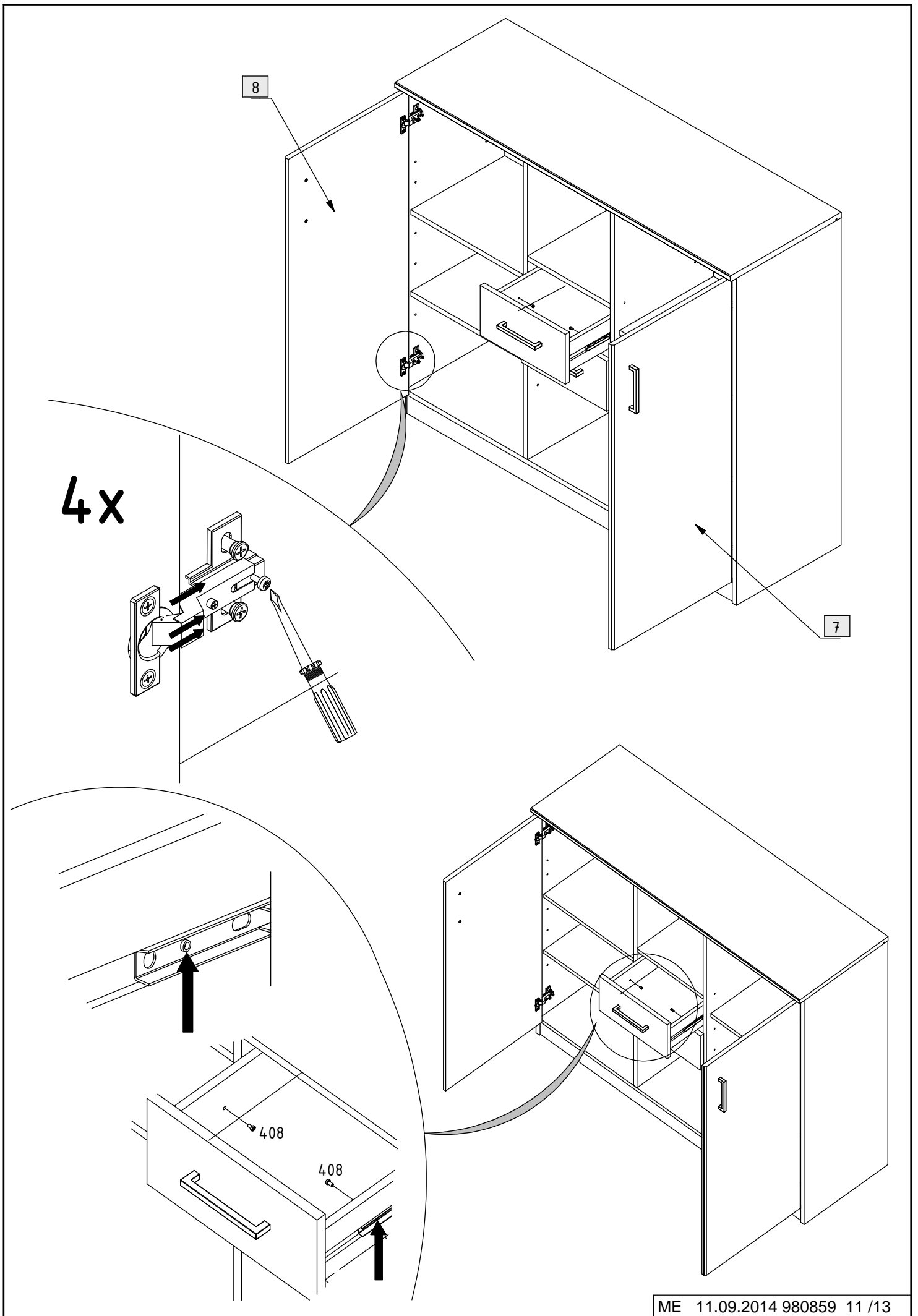

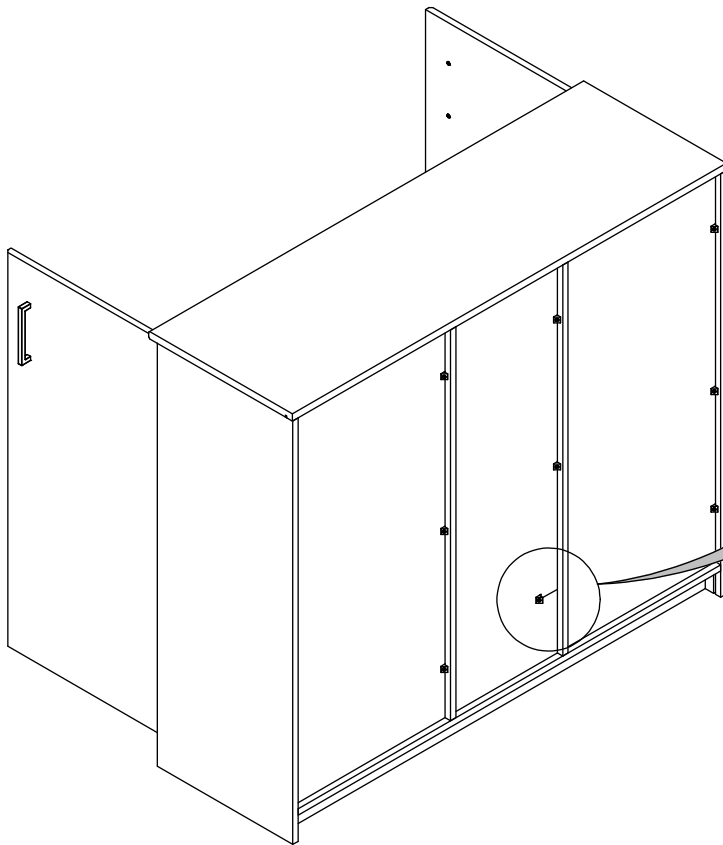
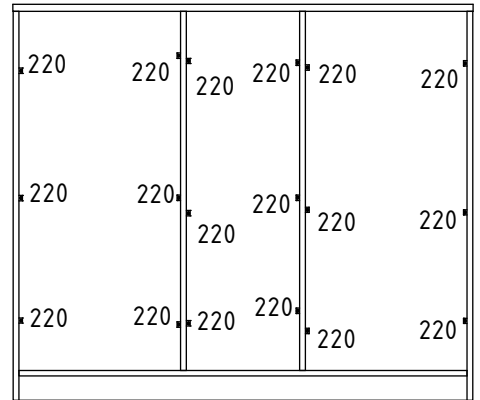
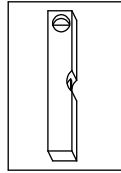
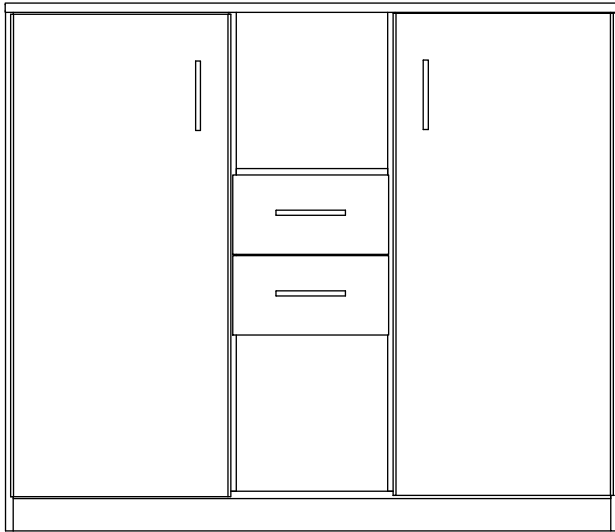
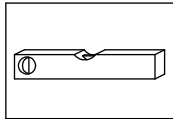

18x



220

