

SC-255  
NINA

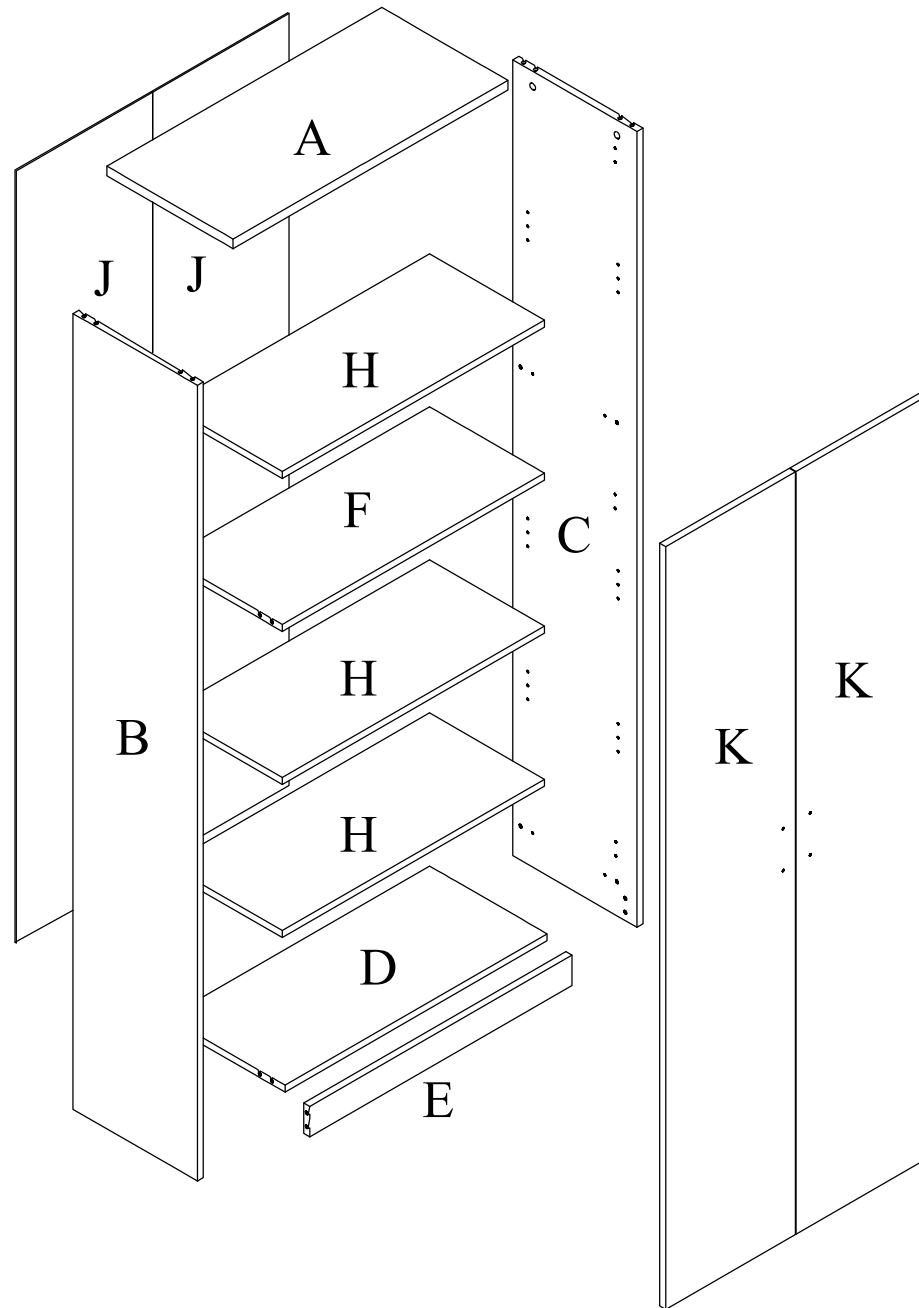

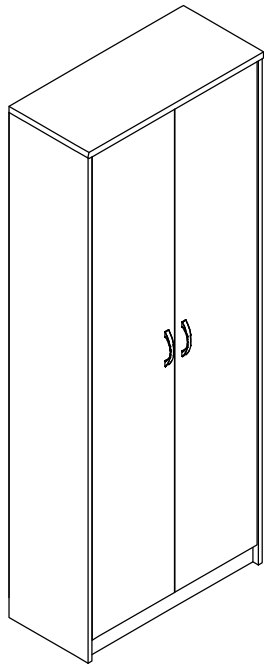

0013K	1x	0036K	6x	0014K	6x
-------	----	-------	----	-------	----

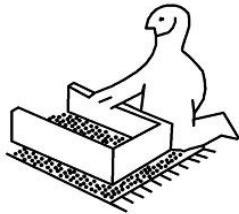
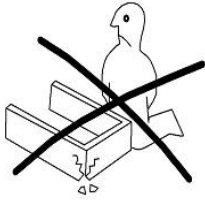
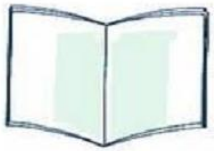
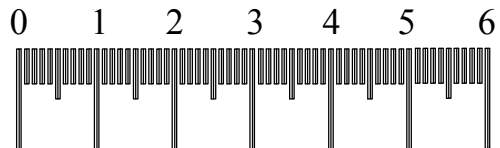
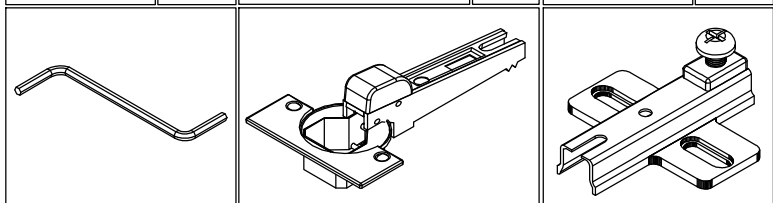

0016U	2x	0018K	12x	0019K	12x
-------	----	-------	-----	-------	-----

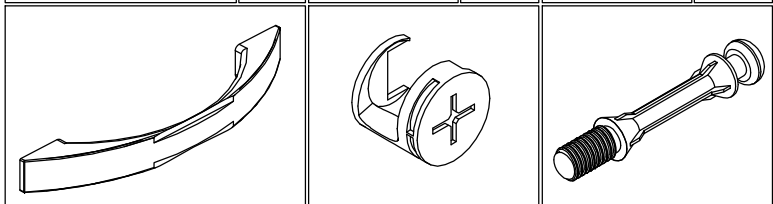

0001K	16x	0009K	12x	0016K	50x	0022V	4x
-------	-----	-------	-----	-------	-----	-------	----

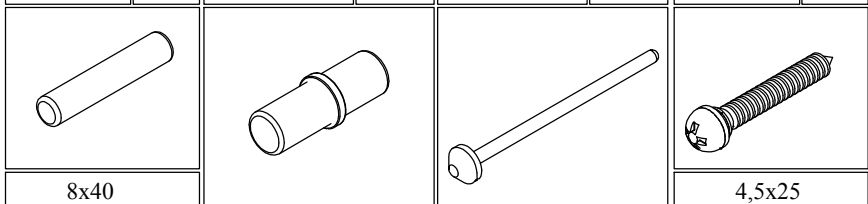

0002K	4x	0027K	1x	0024V	2x	0002V	8x
-------	----	-------	----	-------	----	-------	----

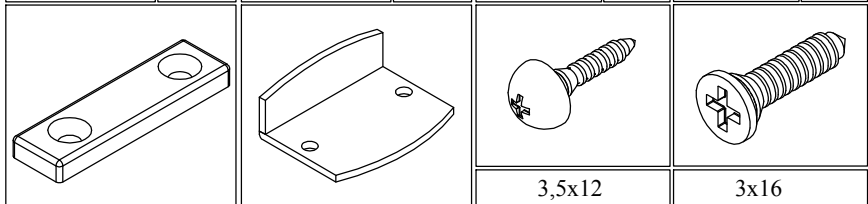

0054K	12x	0001V	24x
-------	-----	-------	-----

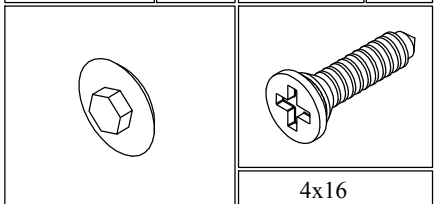

1.)

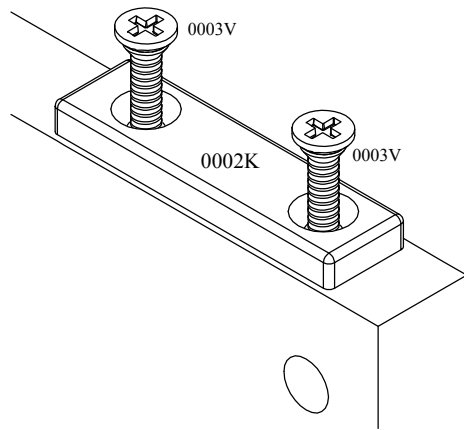
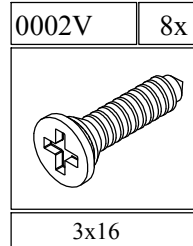
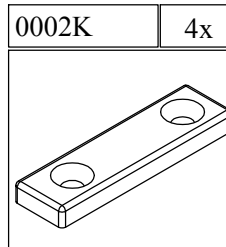
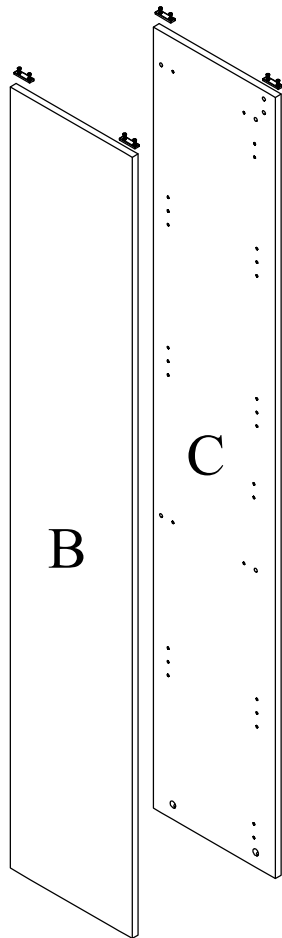

2.)

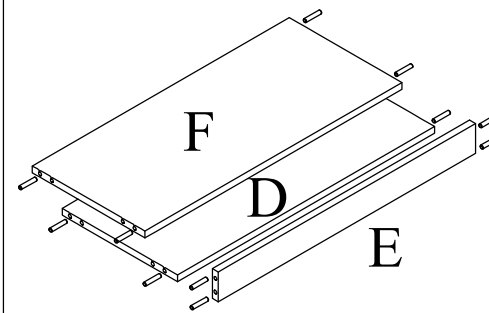
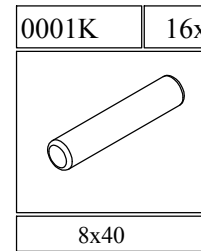
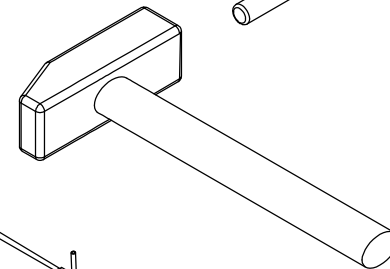
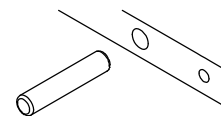
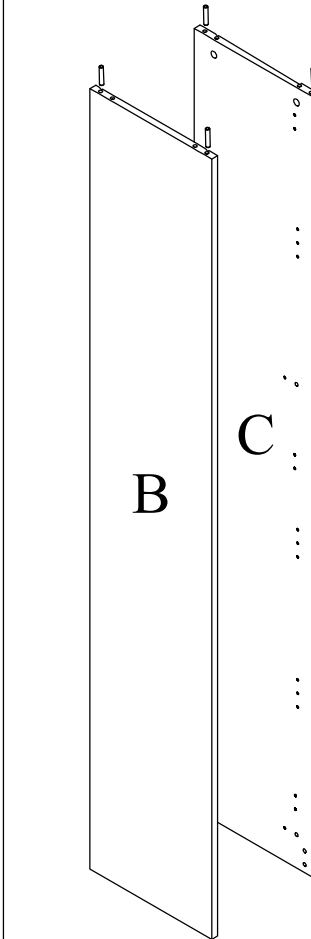

3.)

0019K 12x

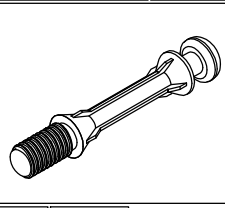

0027K 1x

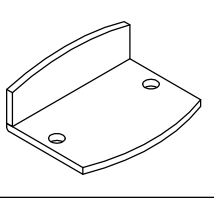

0024V 2x

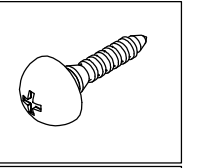

3,5x12

0024V 0027K

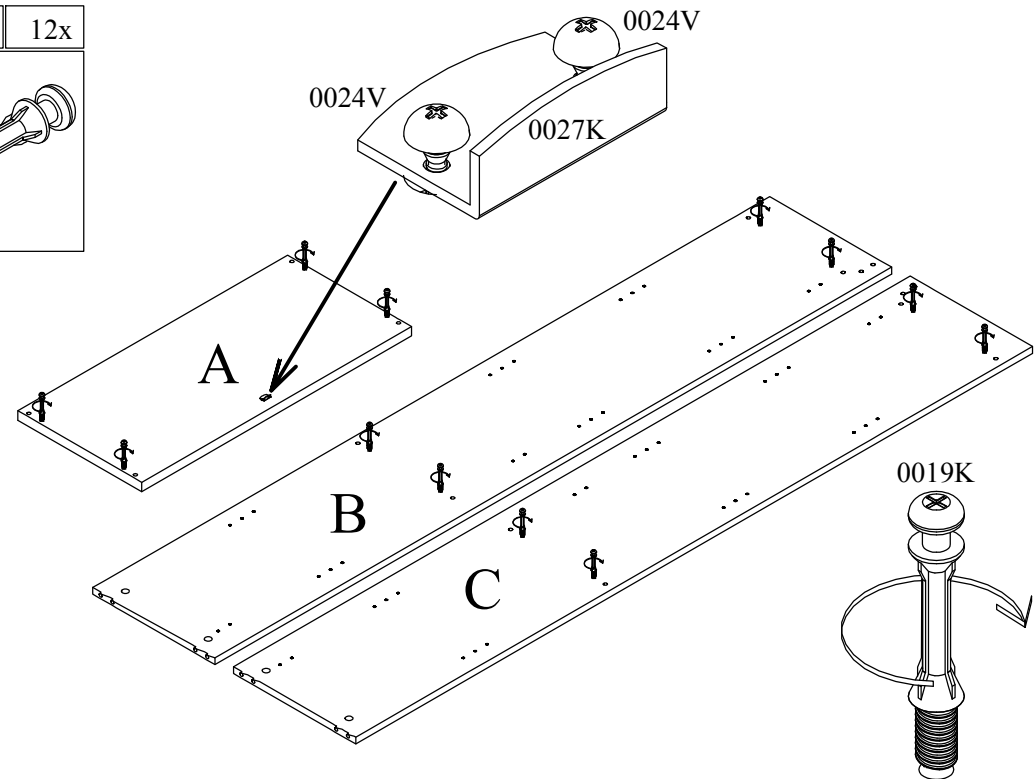

5.)

0016K 50x

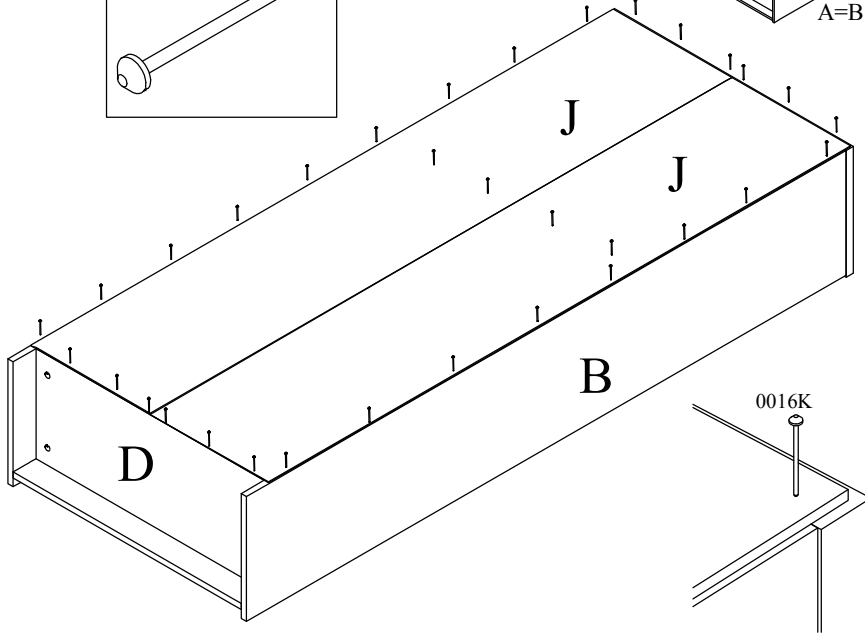
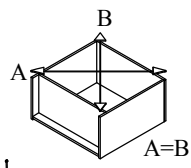
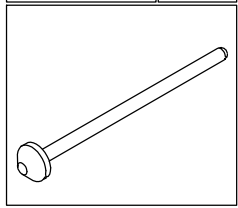

4.)

0013K 1x

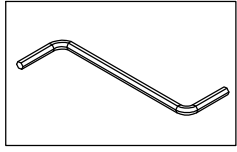

0054K 12x

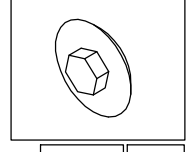

0018K 12x

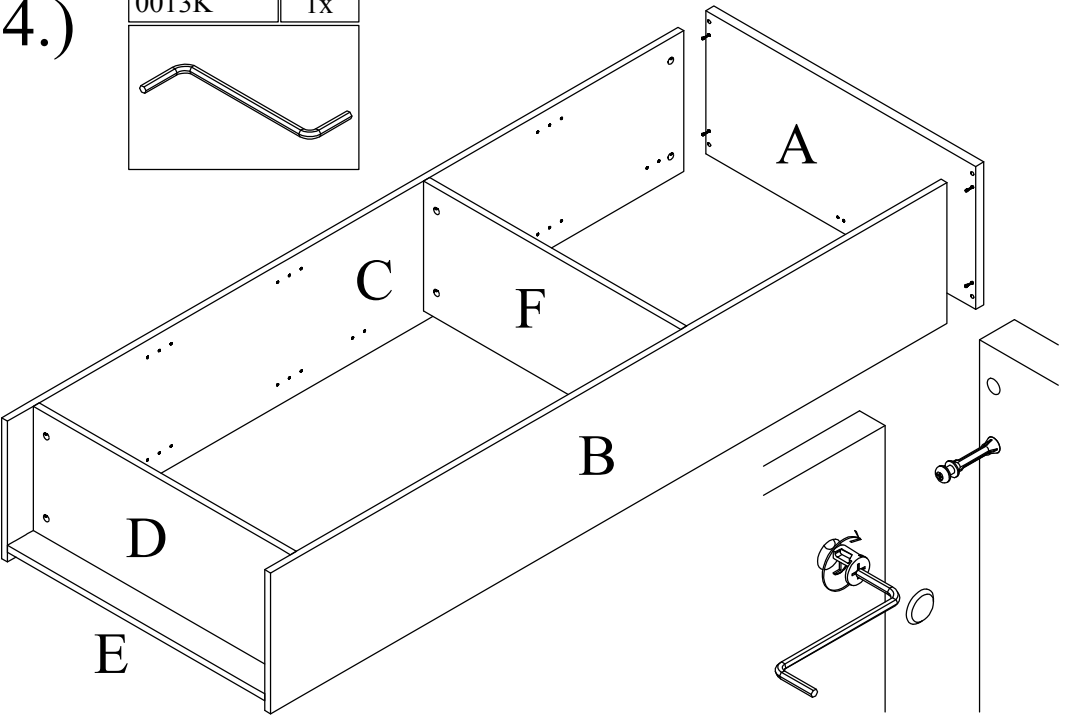
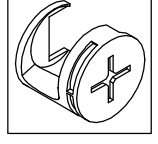

6.)

0009K 12x

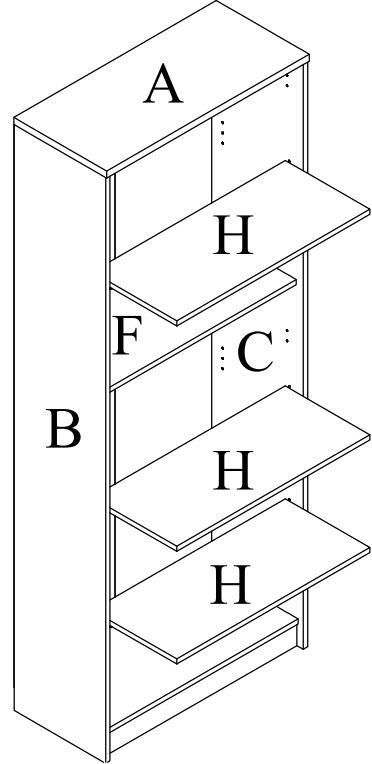
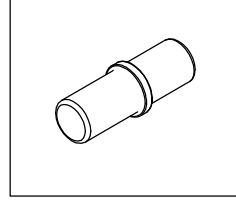

0009K

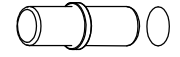

7.)

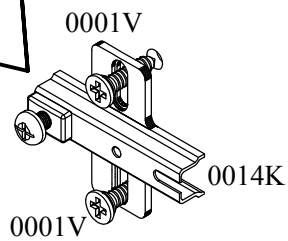
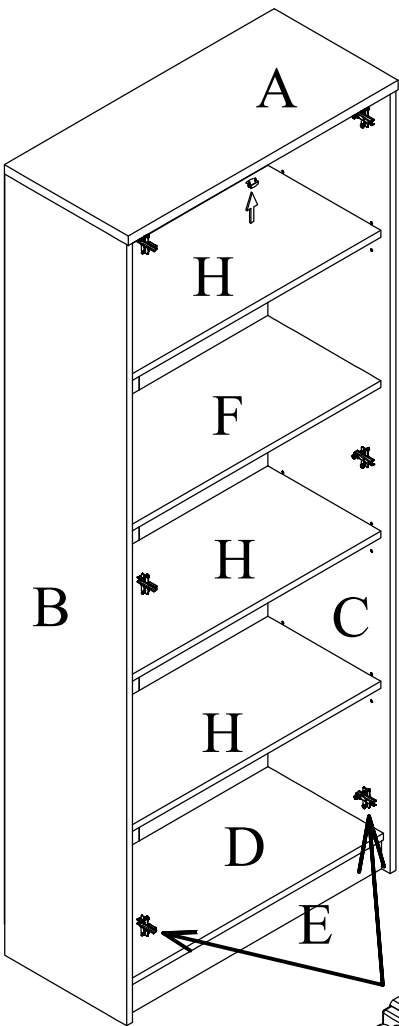
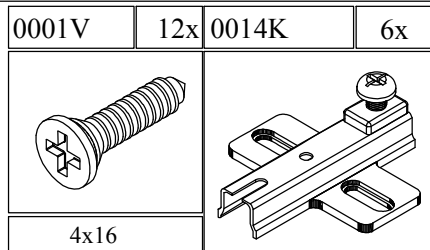

8.)

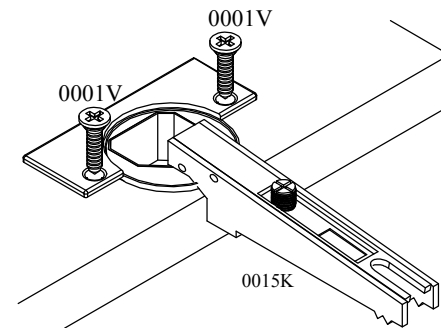
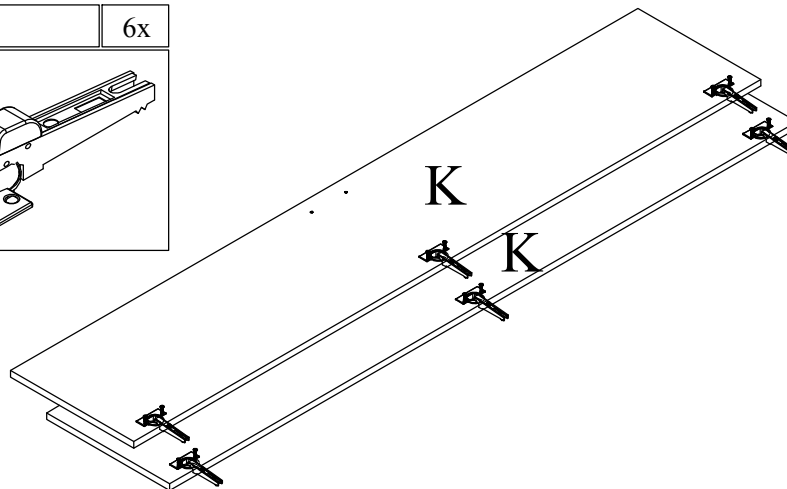
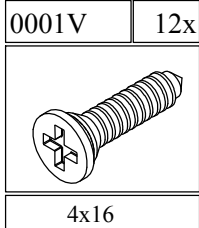
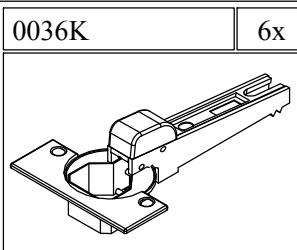

9.)

