

MONTÁŽNÍ/MONTÁŽNY NÁVOD

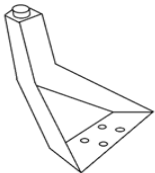

Po složení upravte látku
Po zložení upravte látku

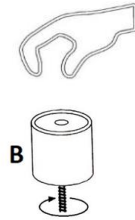
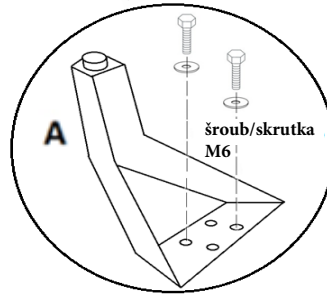
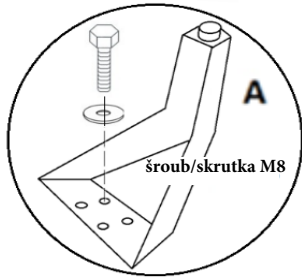
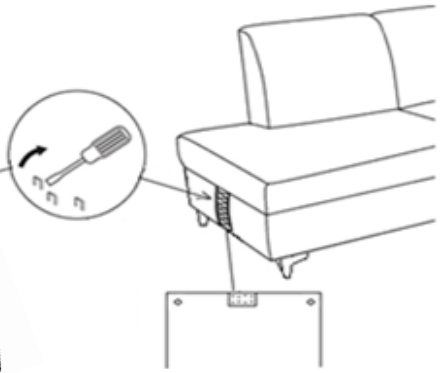
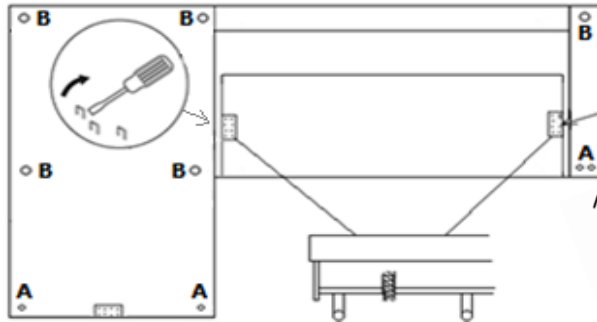
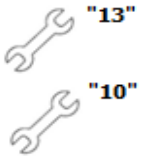
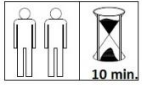

A - 3ks

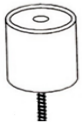

B - 5ks



šroub/skrutka M6 - 2 ks



podložka M6 - 2ks

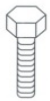

šroub/skrutka M8 - 2 ks



podložka M8 - 2ks

