

980340

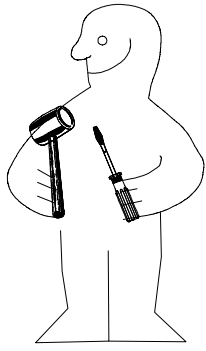

MONTÁŽNÍ/MONTÁŽNY NÁVOD

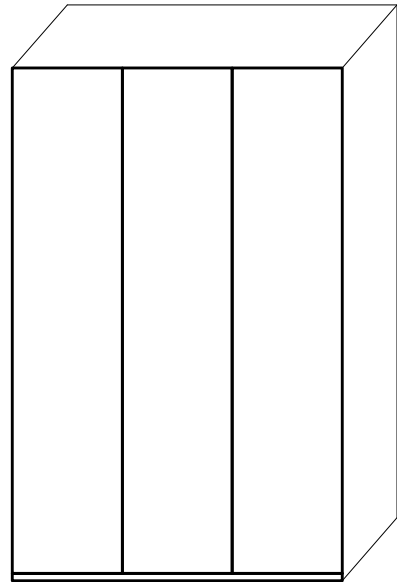



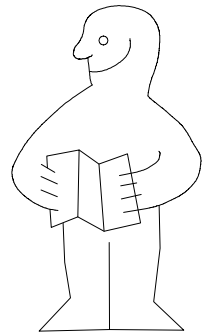
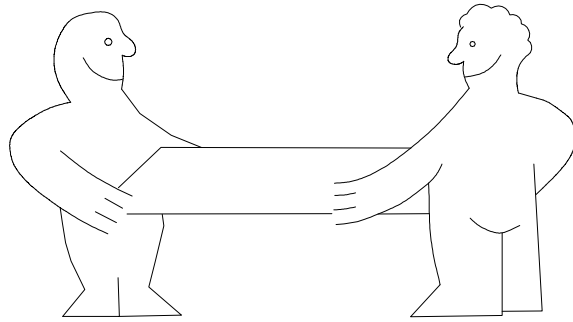
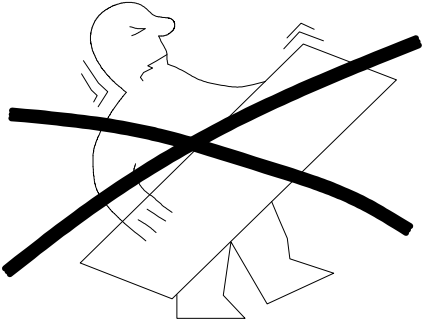

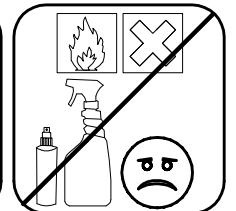
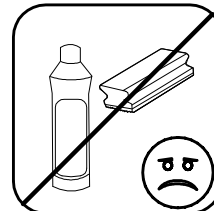
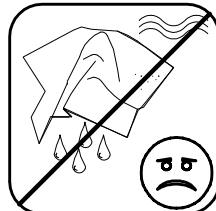
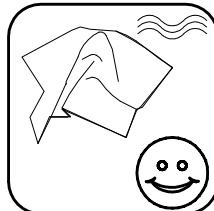
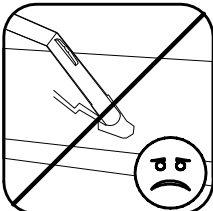
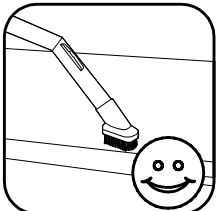
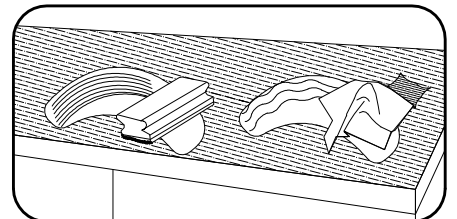
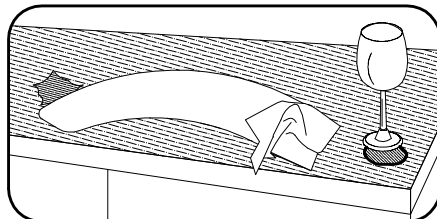
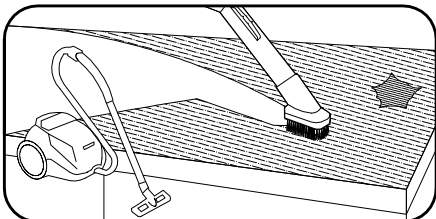
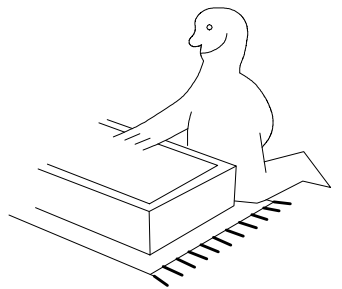
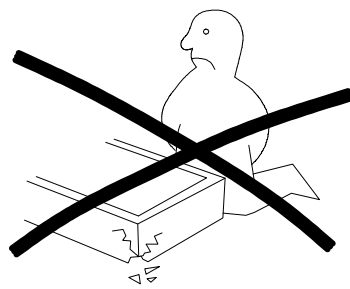
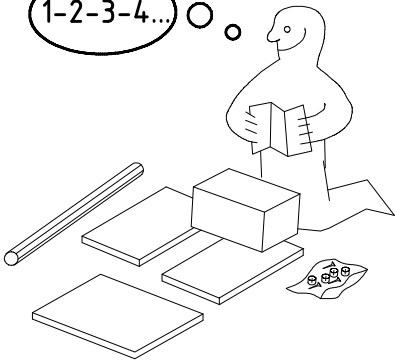

NSP 135



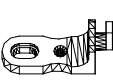

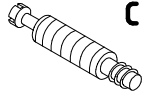

1-2-3-4...

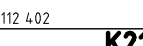

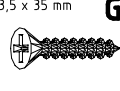
 111 102	A 12x
 111 610	L7 8x
 111 174	J1 4x
 117 001	K1 4x

 111 103	C 12x
 M6 x 11 mm 121 181	T6 4x
 870mm 112 402	K20 1x
 424mm 112 403	K21 1x

 3,5 x 35 mm 121 375	G14 6x
 112 268	M 9x
 112 267	N 9x
 3,5 x 15 mm 121 370	G1 8x

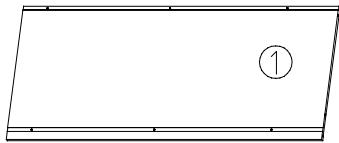
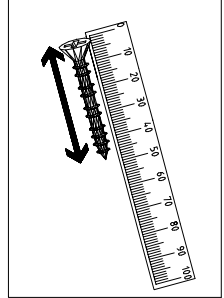
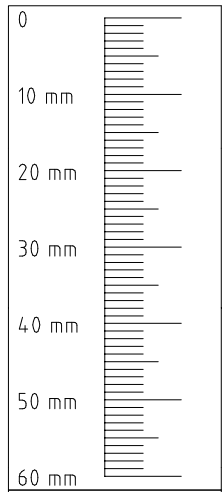
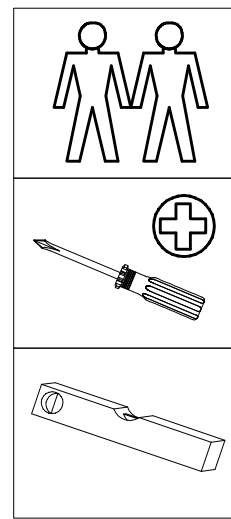

1317x560x15

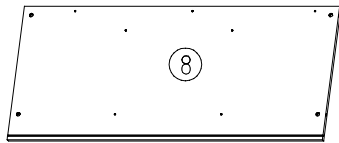

1317x560x15

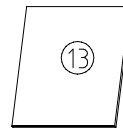

429x500x18

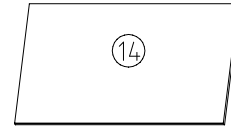

873x500x18

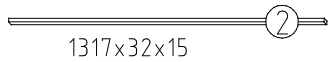

1317x32x15

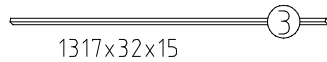

1317x32x15

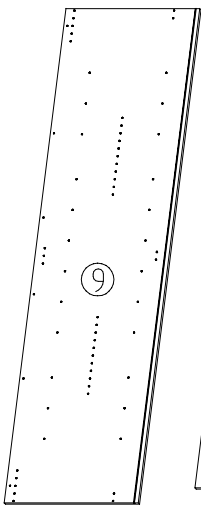

2064x560x15

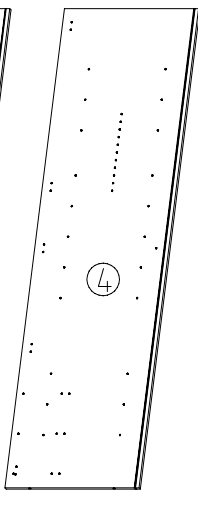

2001x560x15

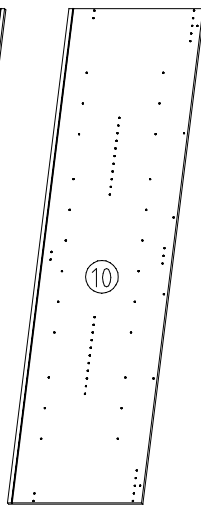

2064x560x15

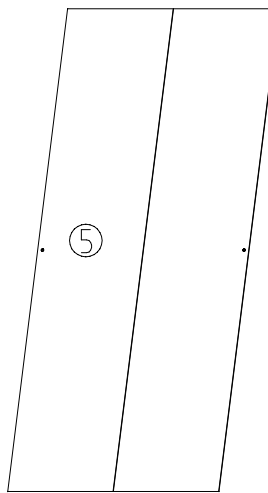

2015x882x2,5

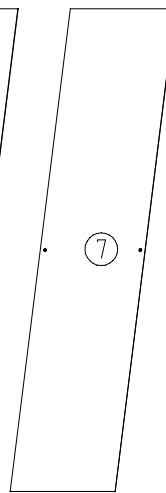

2015x438x2,5

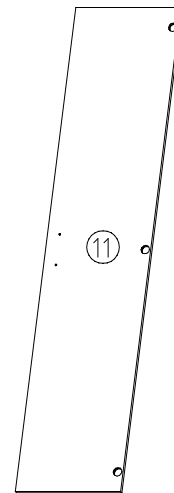

2021x439x15

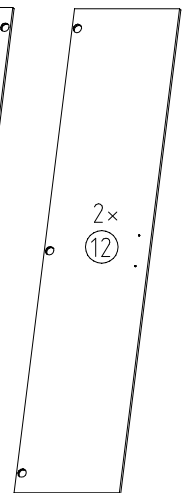

2x
12

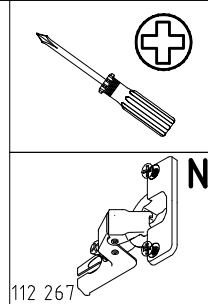
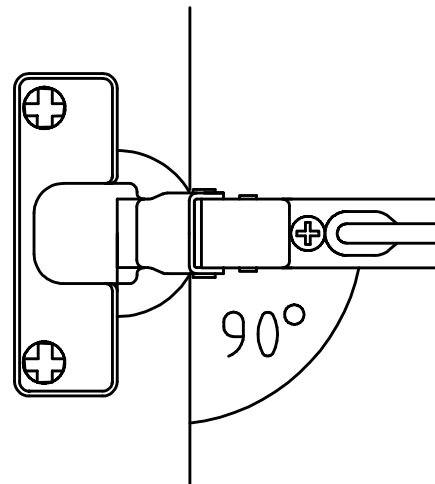
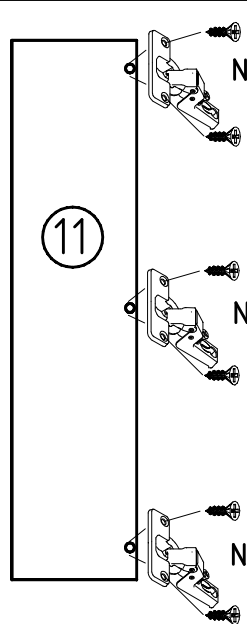
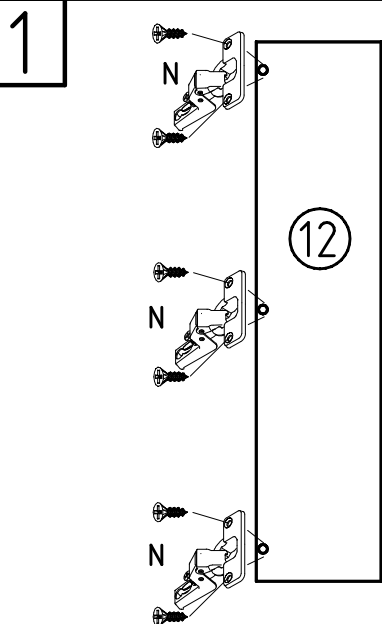

2

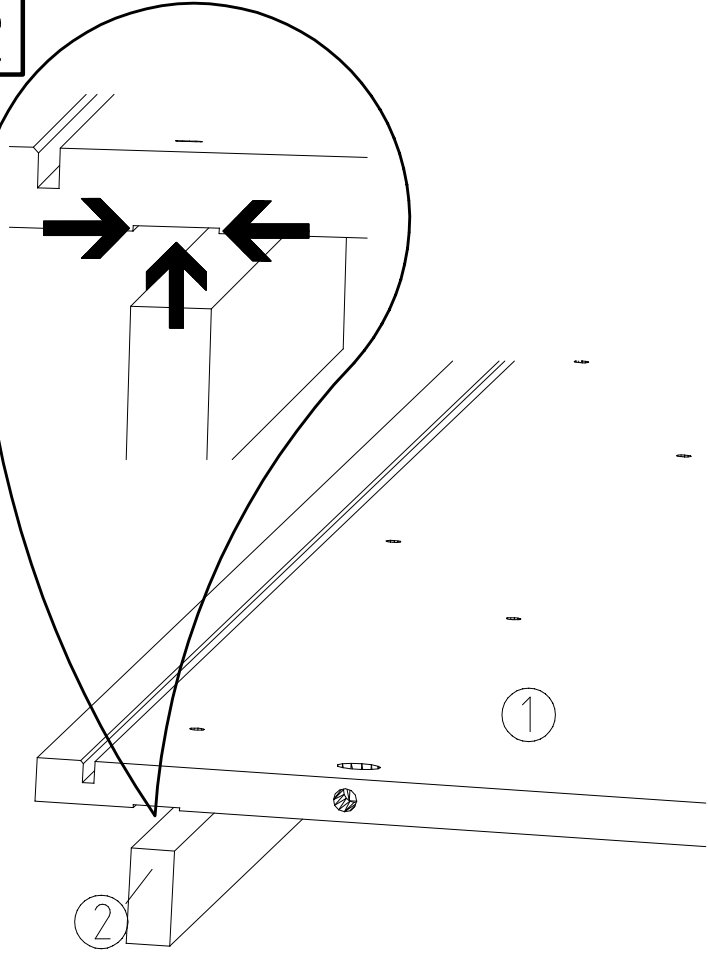

3

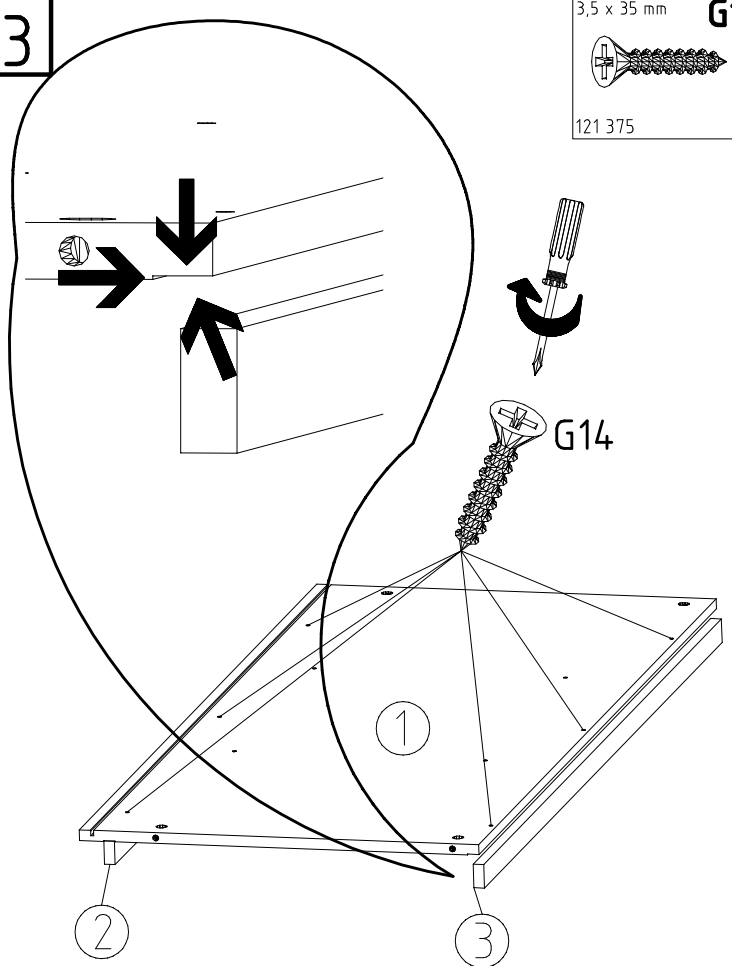





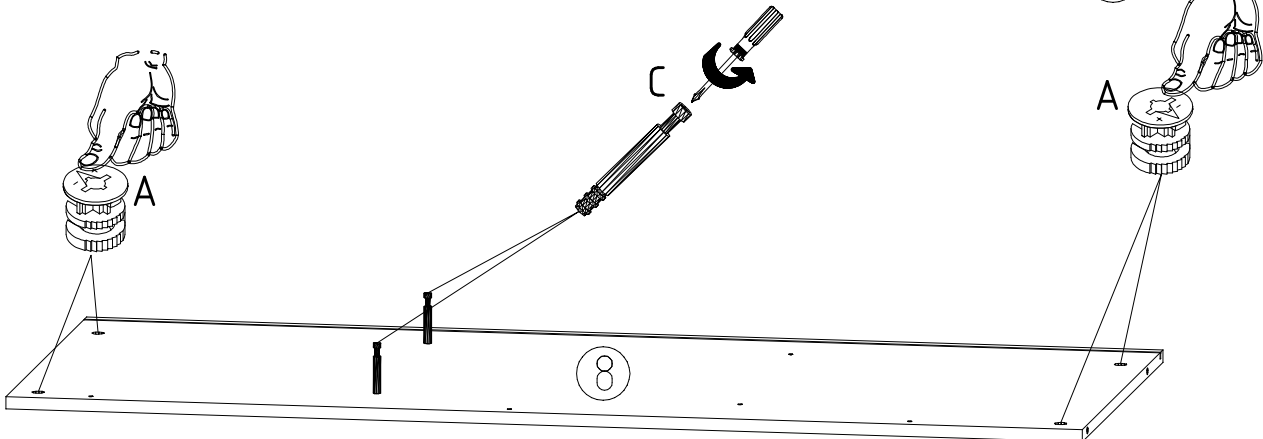
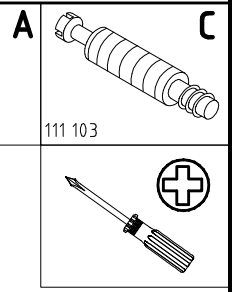
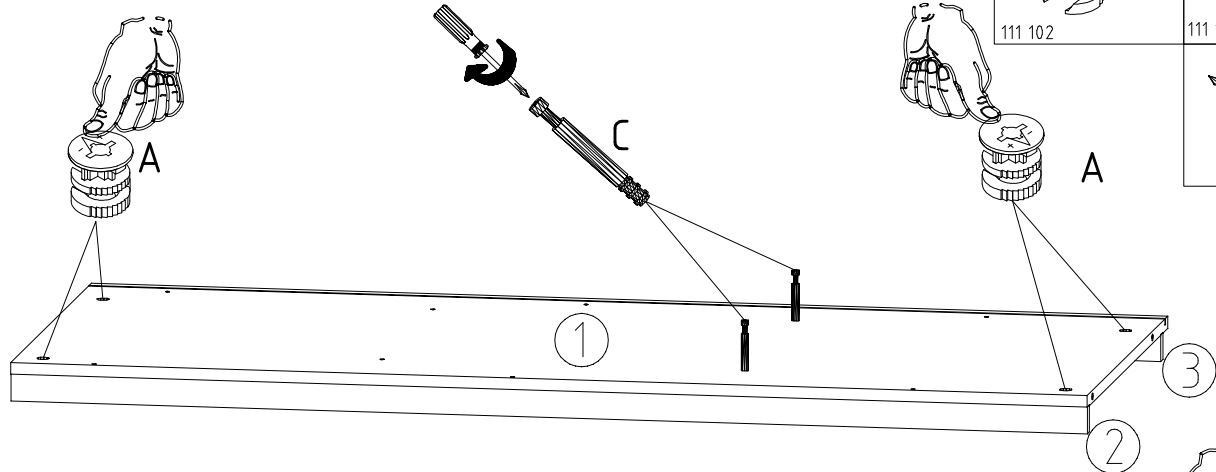
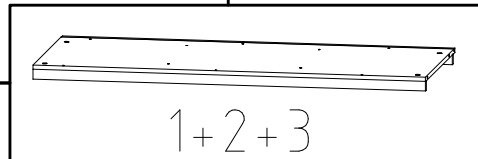

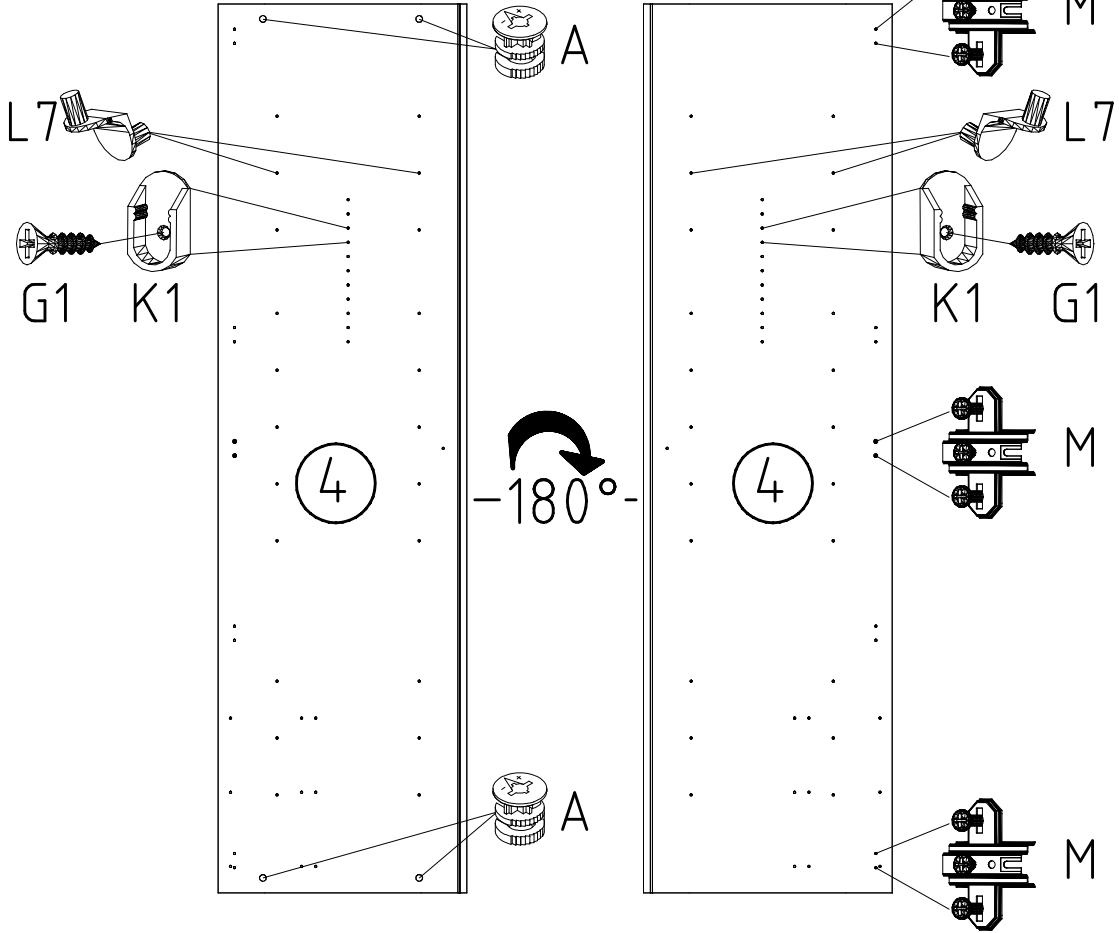

3,5 x 35 mm **G14**

 121 375

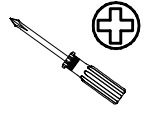
4



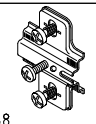





5

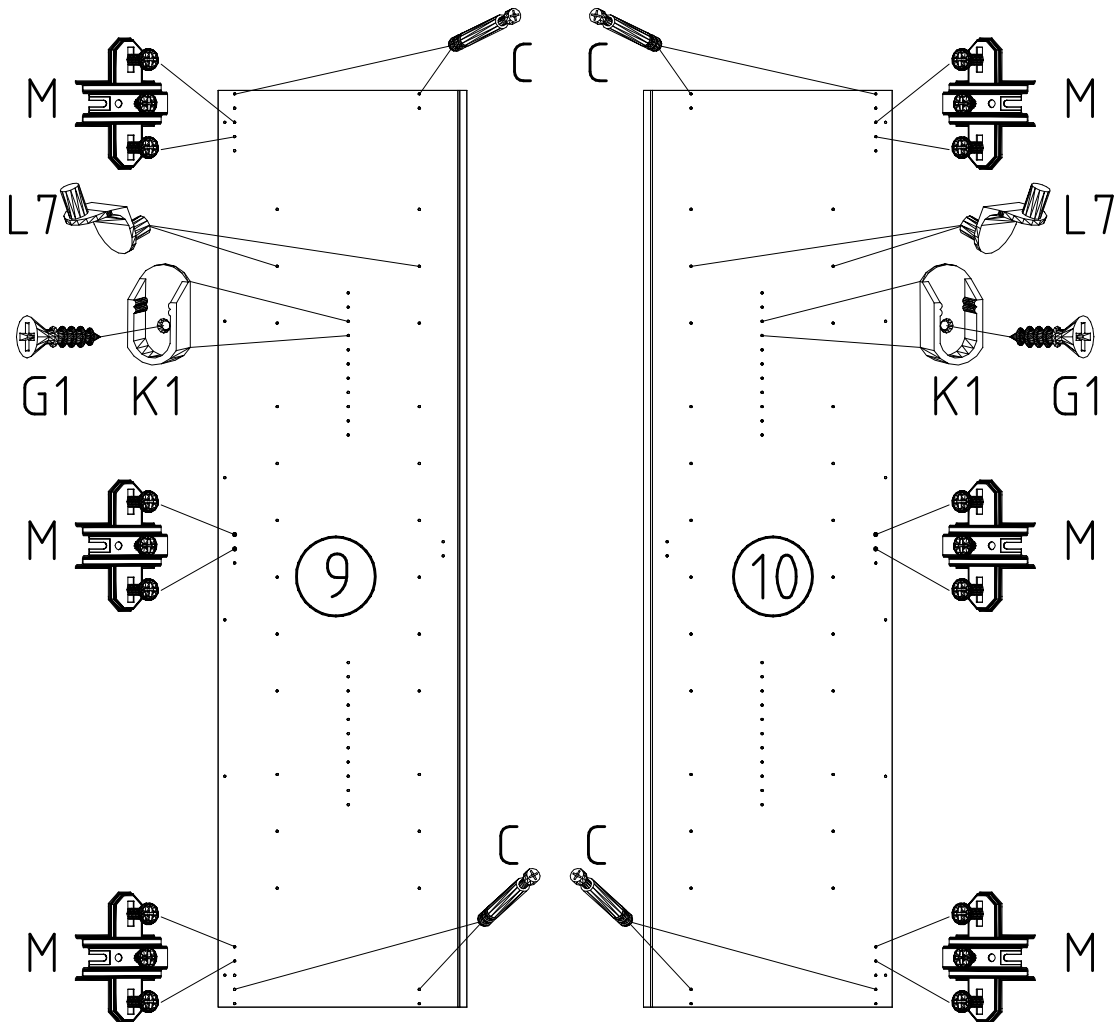

-  L7
111 610
-  
- 3,5 x 15 mm **G1**
 121 370
-  **A**
111 102
-  **M**
112 268
-  **K1**
117 001

6

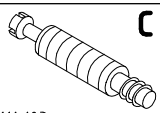
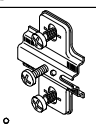

-  L7
111 610
-  
- 3,5 x 15 mm **G1**
 121 370
-  **C**
111 103
-  **M**
112 268
-  **K1**
117 001

7

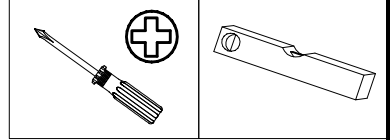
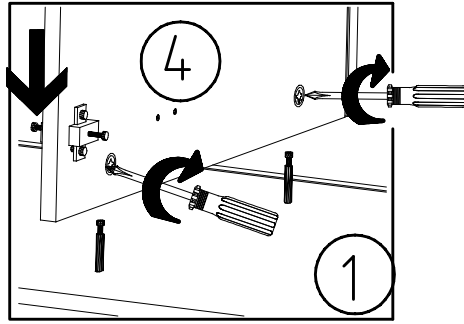
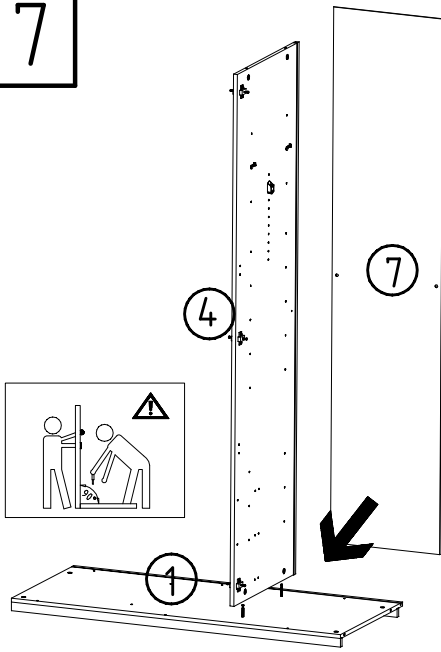

8

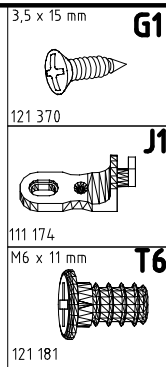
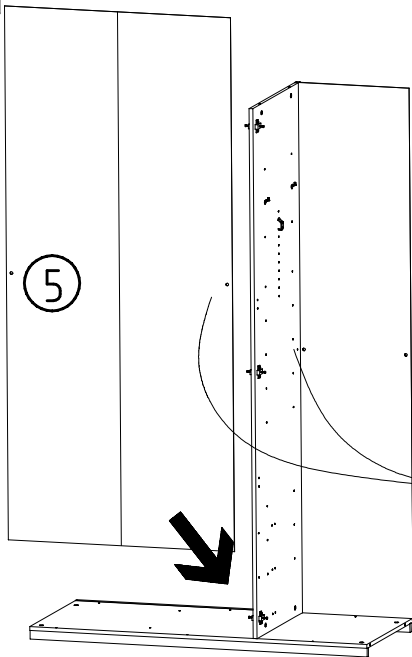

9

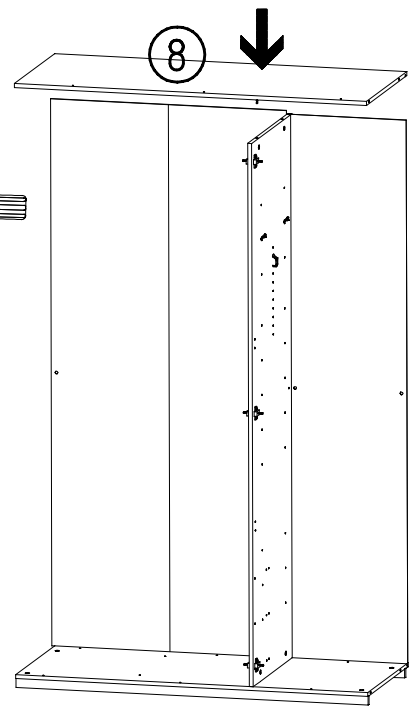
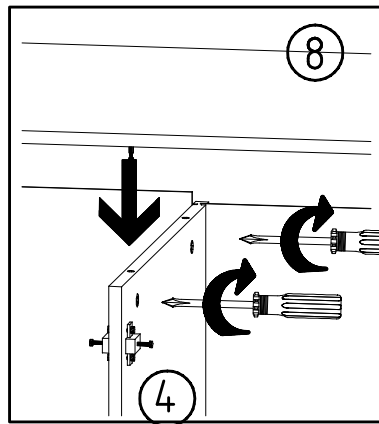

10

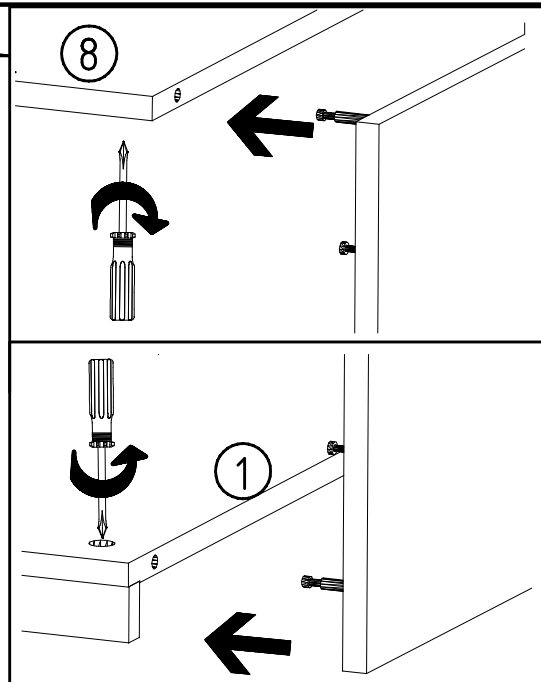
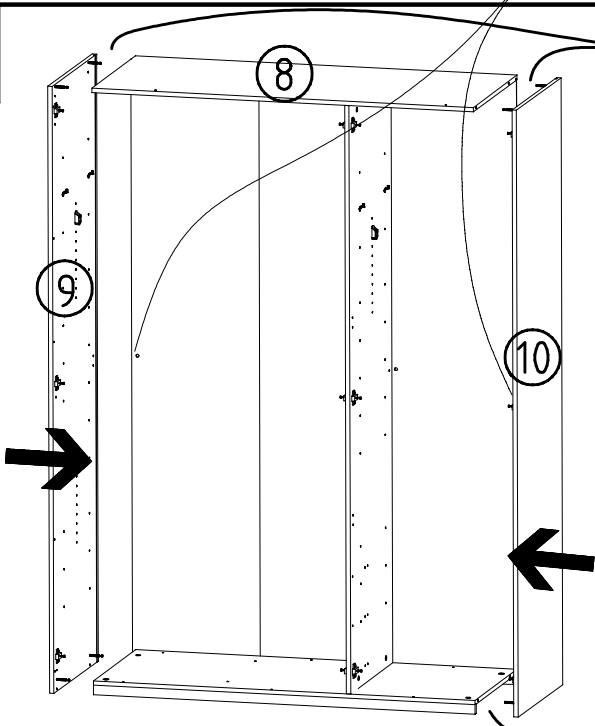

11

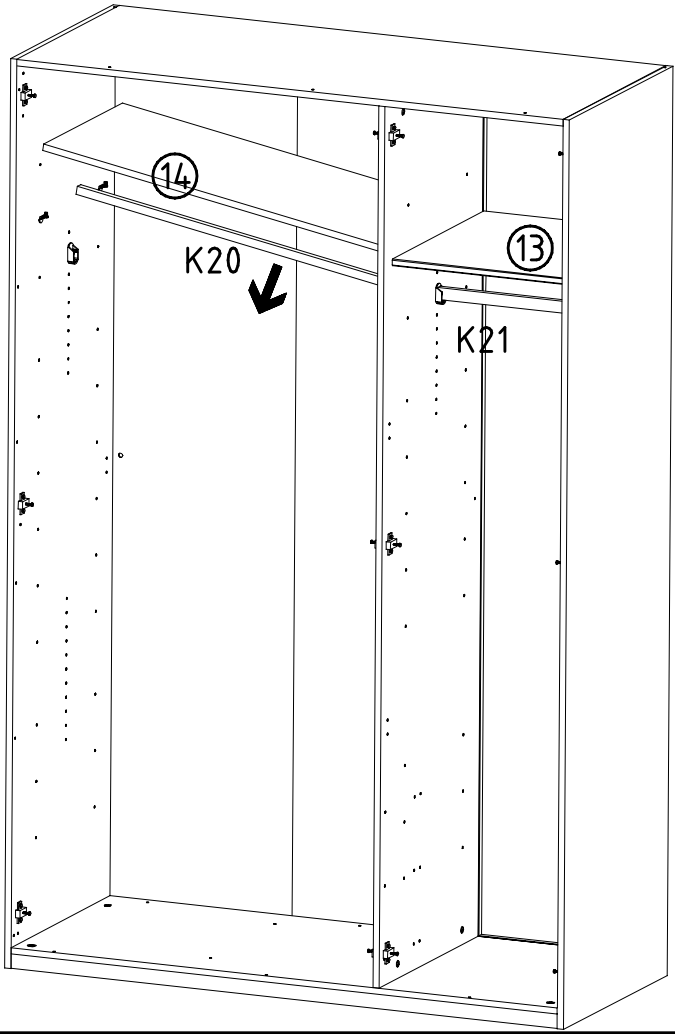

	K20
870mm	
112 402	
	K21
424mm	
112 403	

12

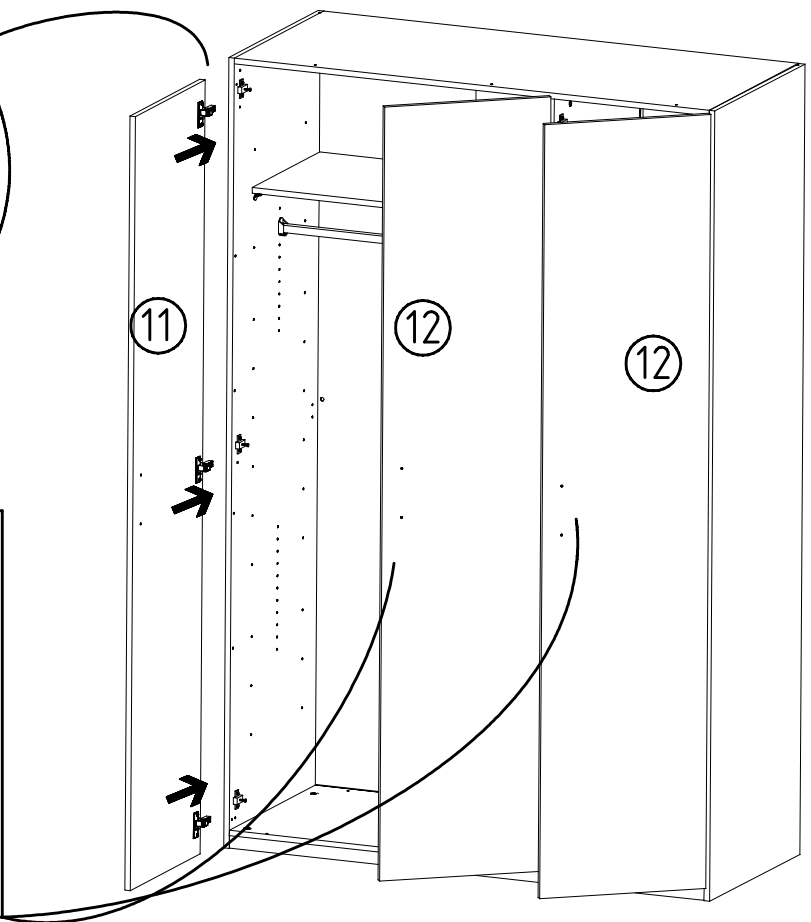
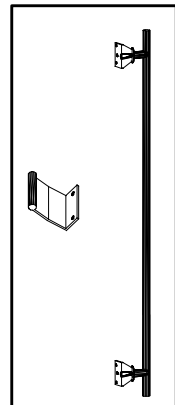
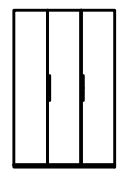
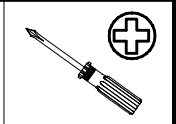
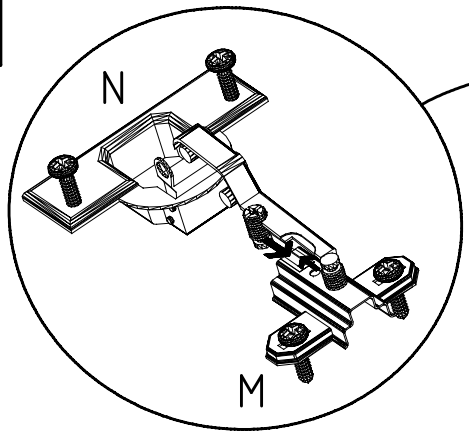

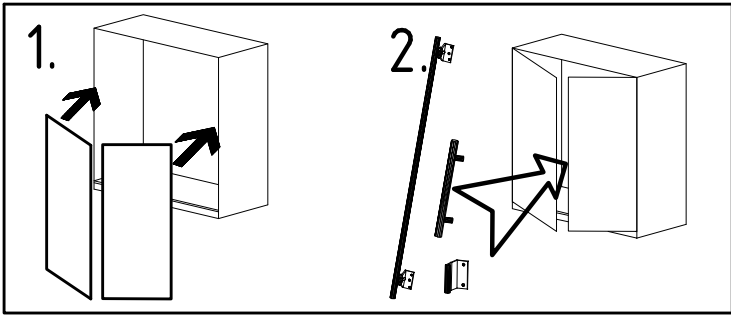
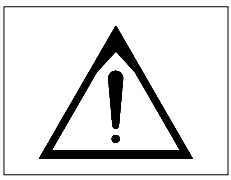

3,5 x 15 mm 121 370 	G1 4,0 x 12 mm 122 625 	G56
----------------------------	----------------------------------	---------

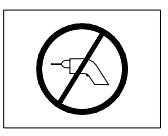
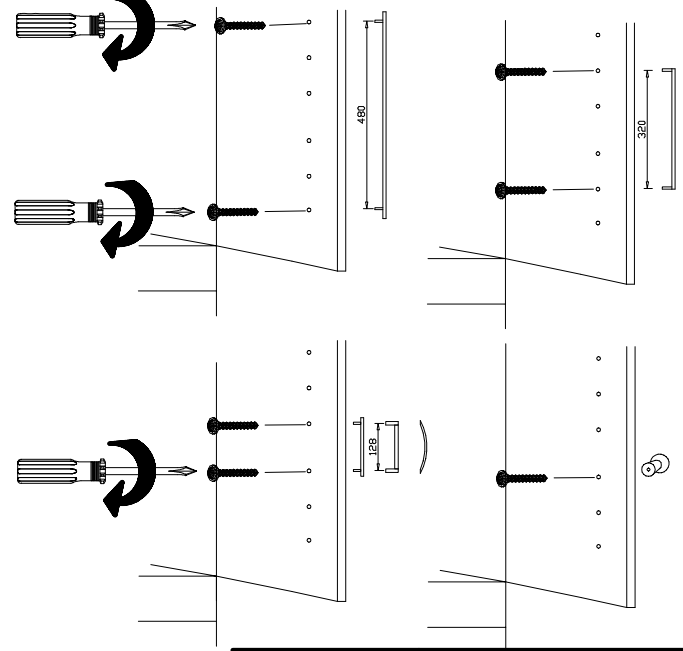
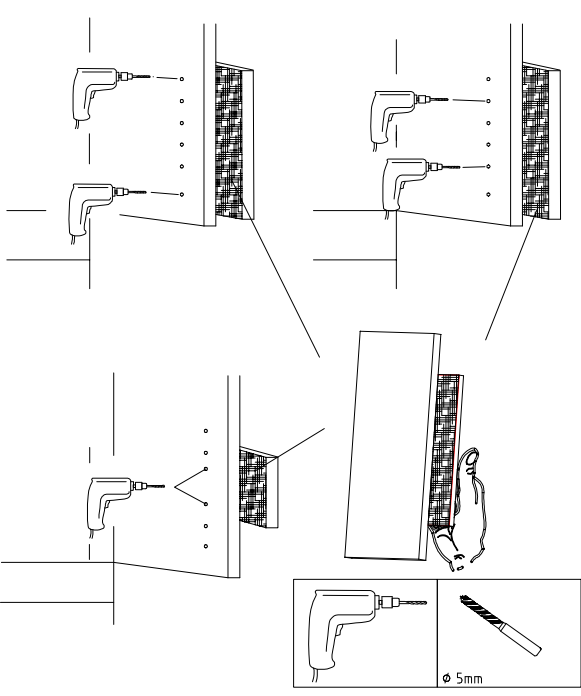
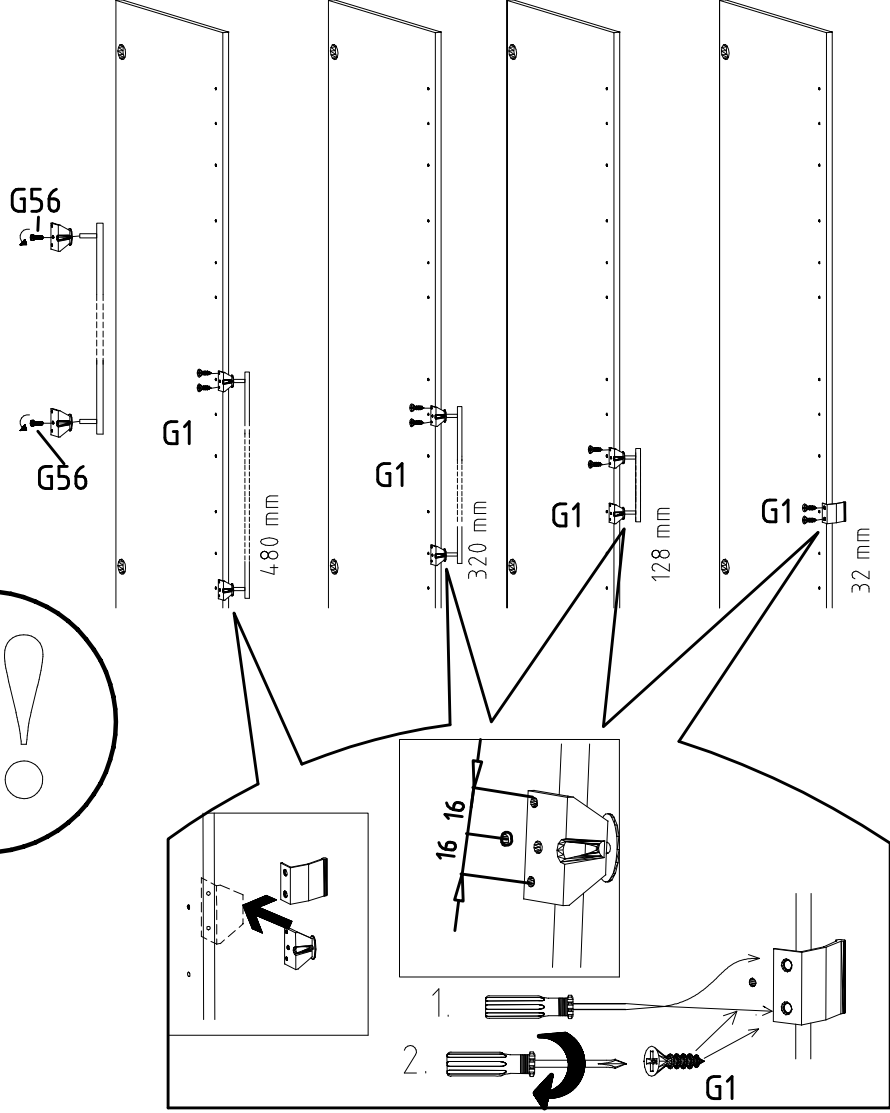
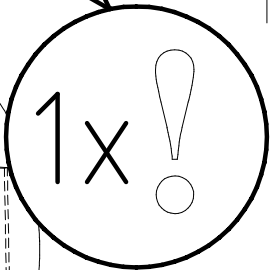
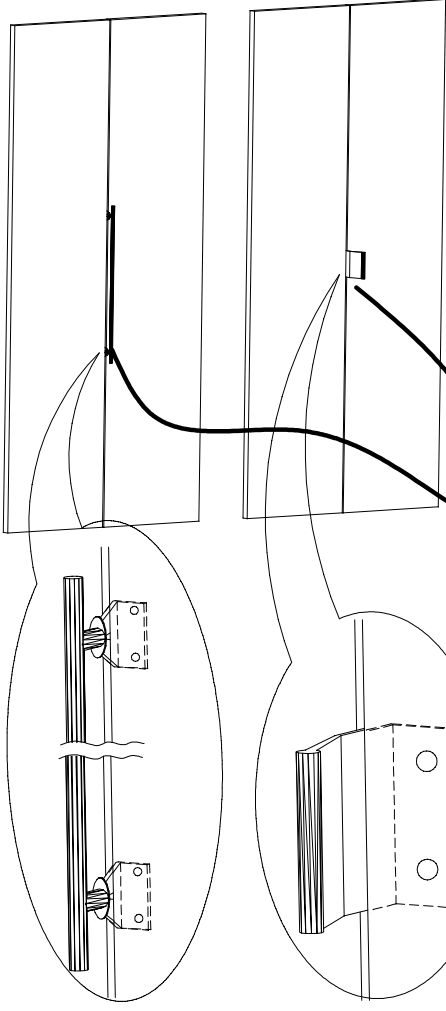

	SP27
4 X 27mm	
122620	
4,0x22	G49
122 609	

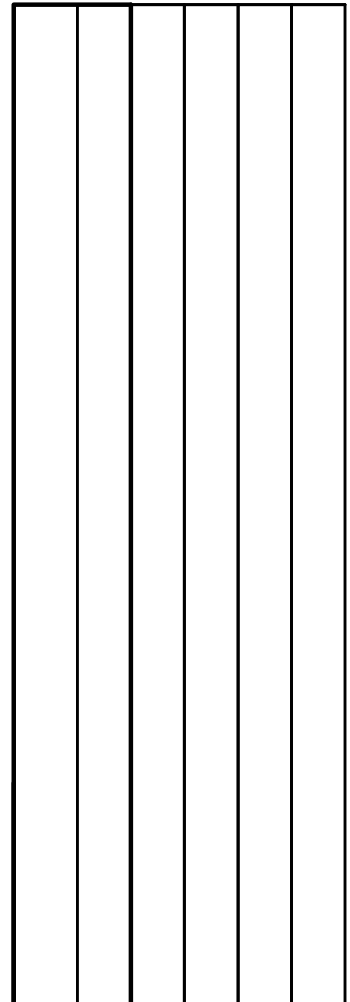
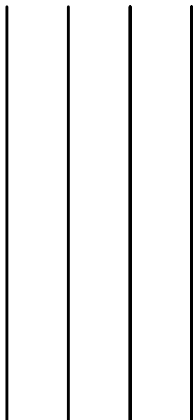
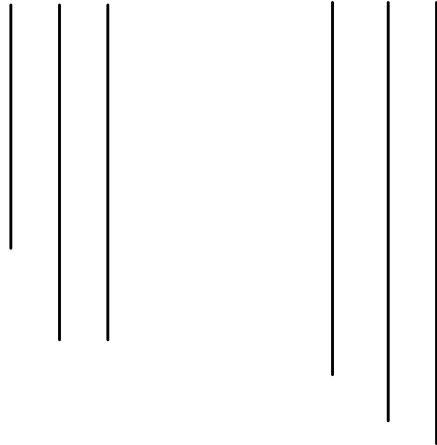
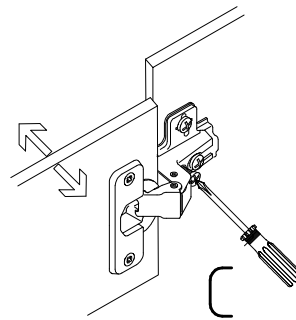
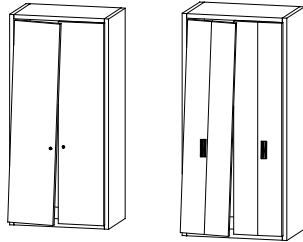
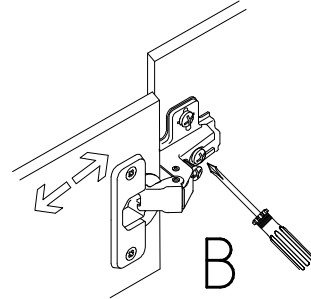
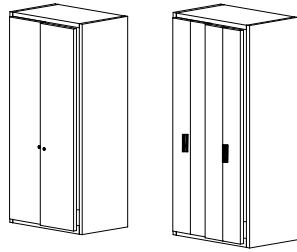
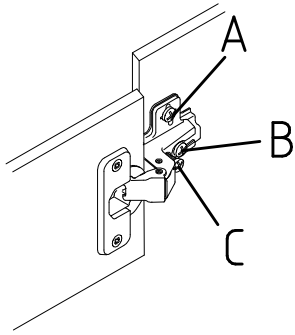
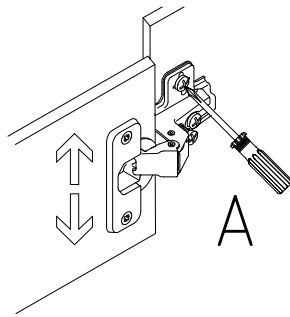
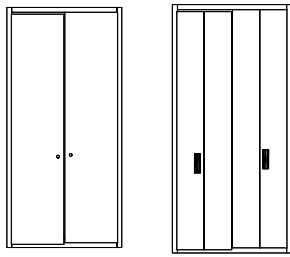

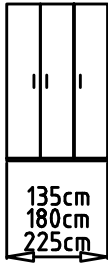
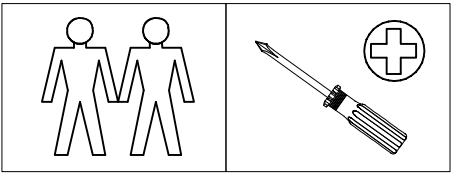
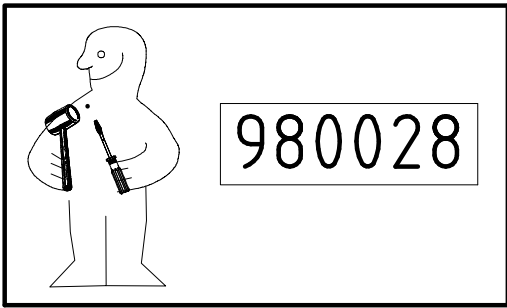

1348/ 1792/ 2236 x120x22

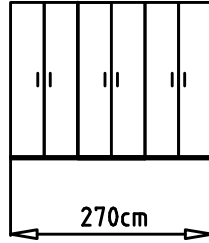
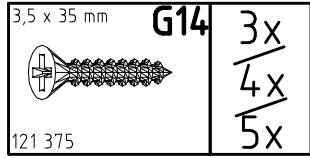

1792 x120x22

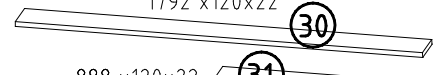

888 x120x22

