

ARMARIO 1 ECO TYP B

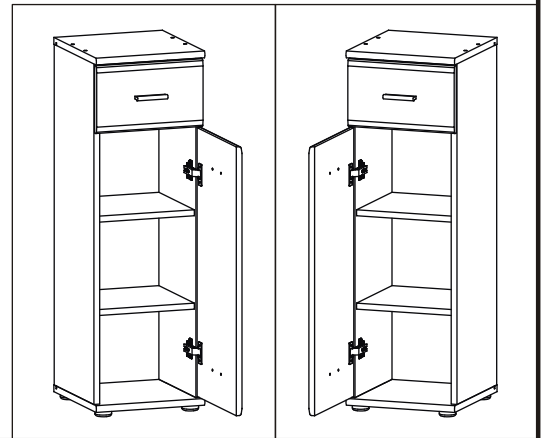

NO	Dim.			Col.-No	Qty
1	714	296	16	1	1
2	296	180	16	1	1
3	905	300	16	1	1
4	905	300	16	1	1
5	302	322	18	1	1
6	302	322	18	1	1
7	250	132	16	1	1
8	250	132	16	1	1
9	211	112	16	1	1
10	268	268	16	1	2
11	223	253	3	1	1
12	916	279	3	1	1

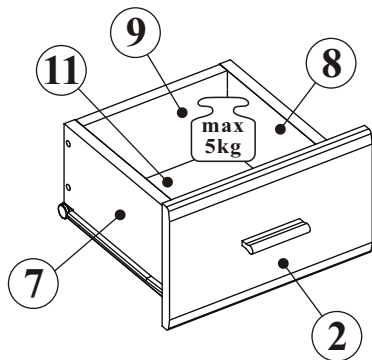
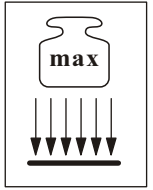
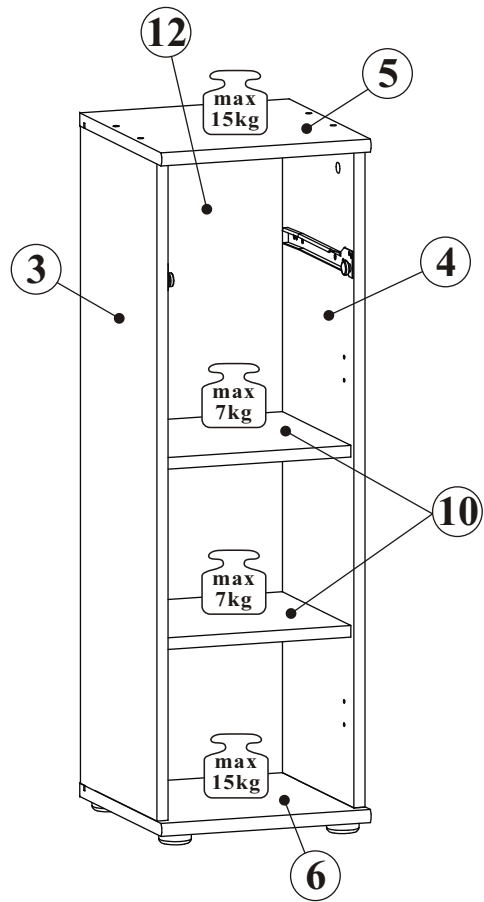
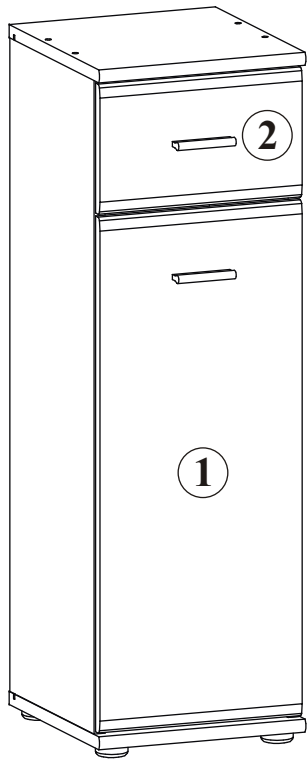
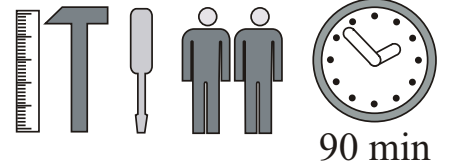

ARMARIO 1 ECO TYP B

A1 x12 ø8x36	B4 x6	B5 x6 ø15x12	G5 x6	B11 x8 Ø7x50	G4 x8
E1 x2 Ø26 H=0	E2 x2 H=0	D10 x10 USØ3,5x13	KL x2 L-64mm	UP6 x4 UPØ4x30	Z2 x2 Ø5
H5 x1 L-250mm	D8 x4 ESØ5x13	B3 x5 Ø1,4x25	I11 x4	UP11 x4 UPØ4x20	G7 x8
S1 x9	G2 x1	L1 x1	KR1 x1 Ø8		

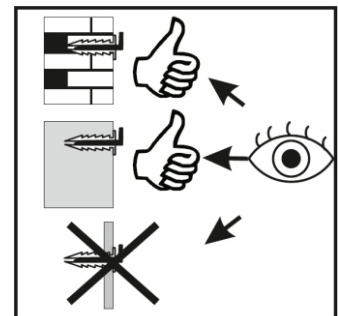
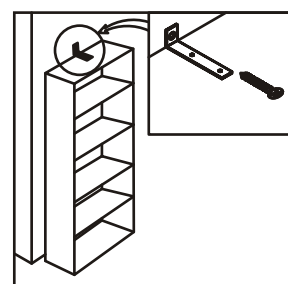
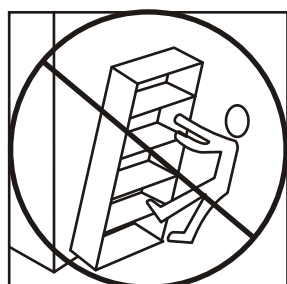
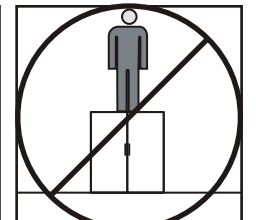
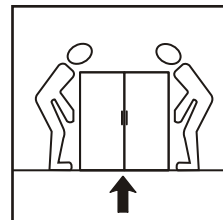
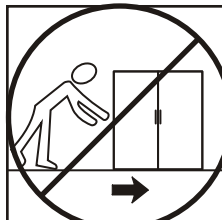
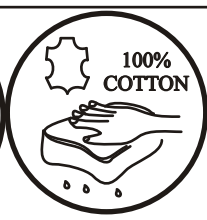
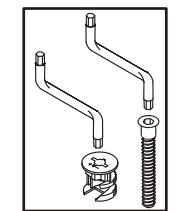
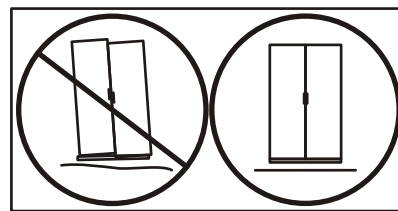
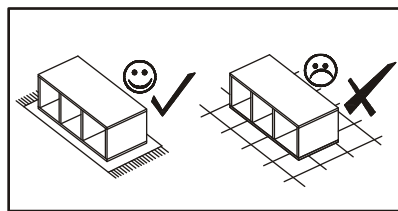
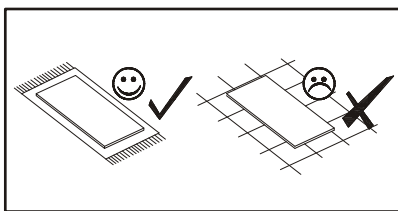
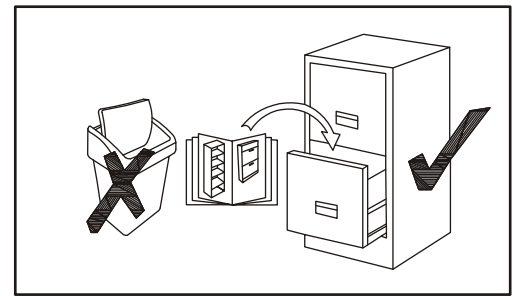
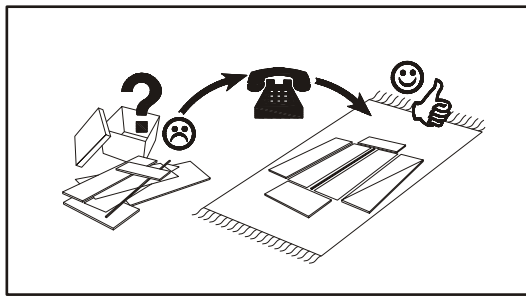
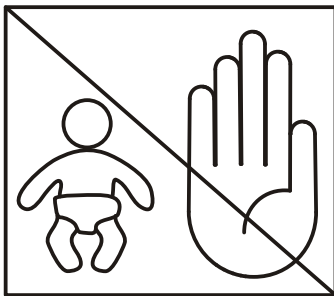
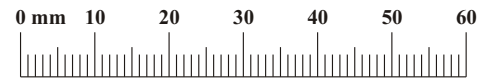

ARMARIO 1 ECO TYP B

1

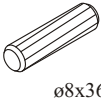
A1	
x8	ø8x36

B5	
x4	ø15x12

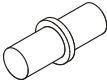
G7	
x8	

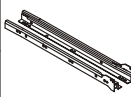
H5	
x1	L-250mm

D8	
x4	ESØ5x13

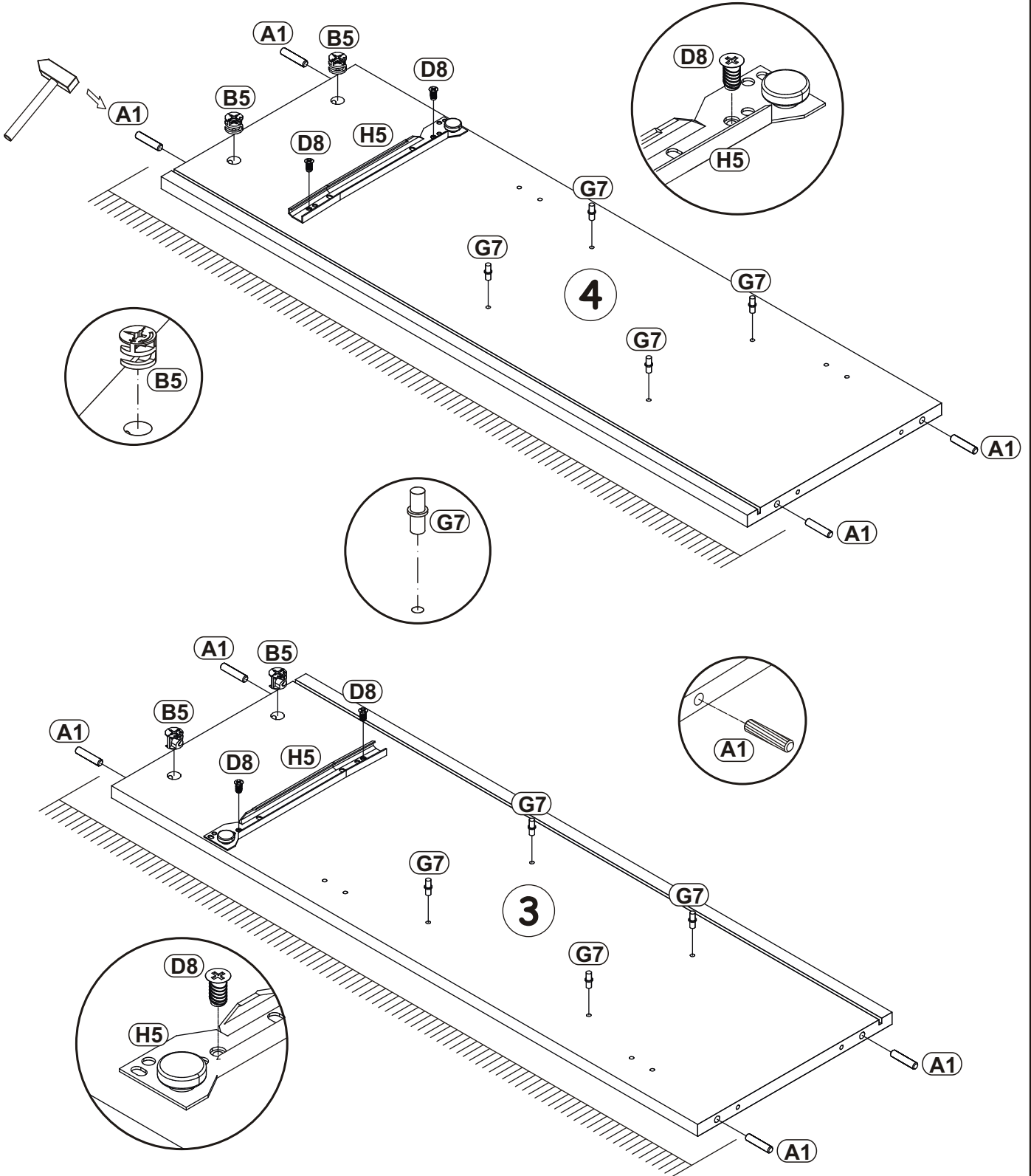

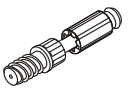

2

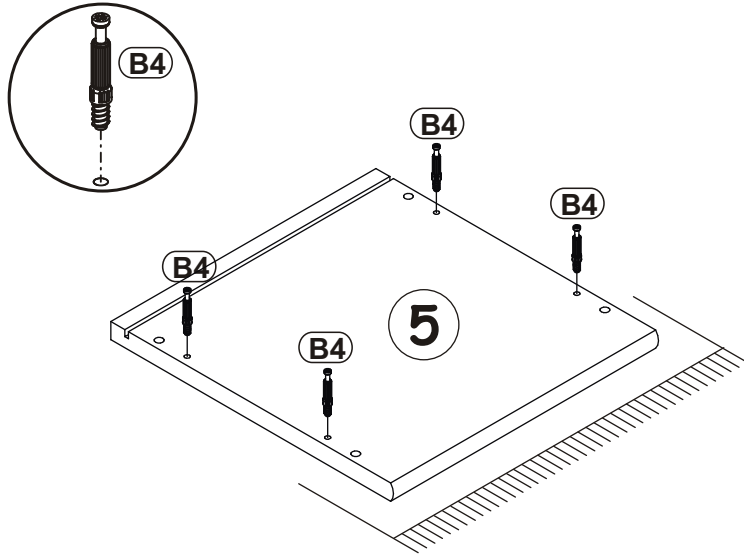
B4	
x4	

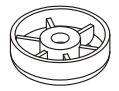

3

I11	
x4	

UP11	
x4	UPØ4x20

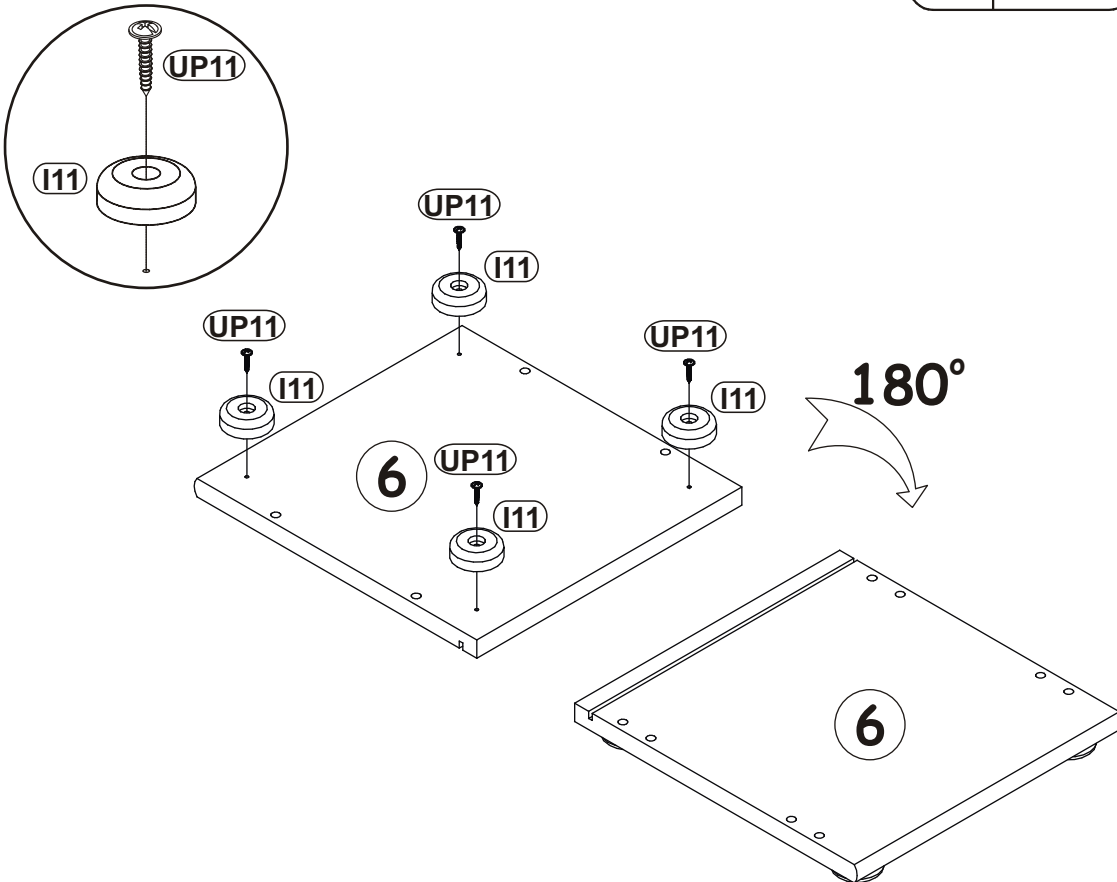

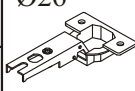
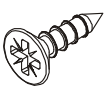

4

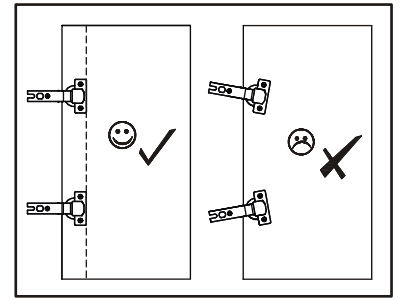
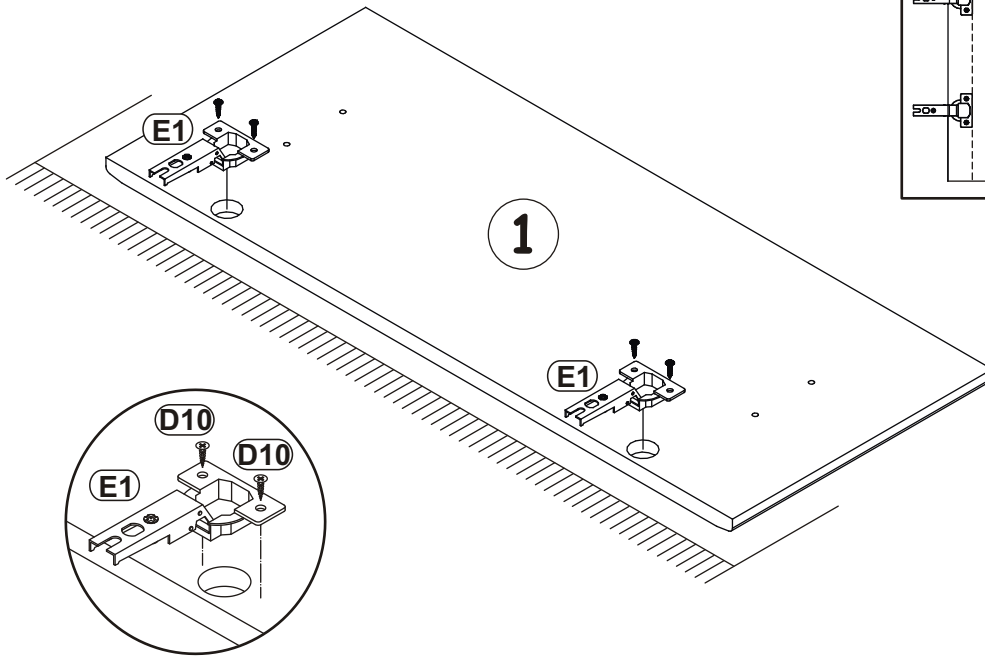
E1	Ø26 	D10	
x2	H=0	x4	USØ3,5x13



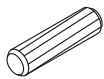
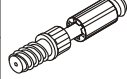

5

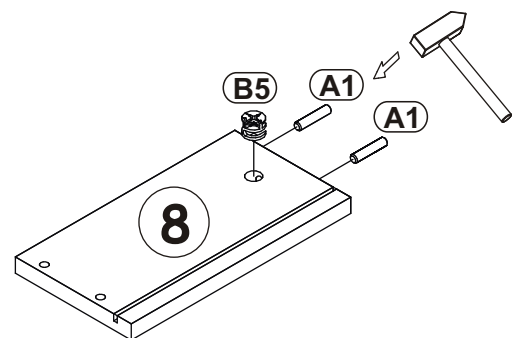
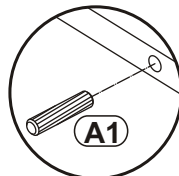
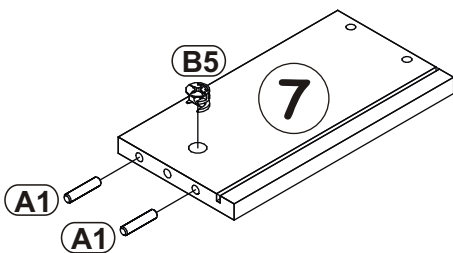
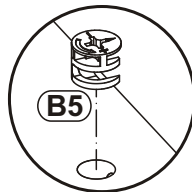
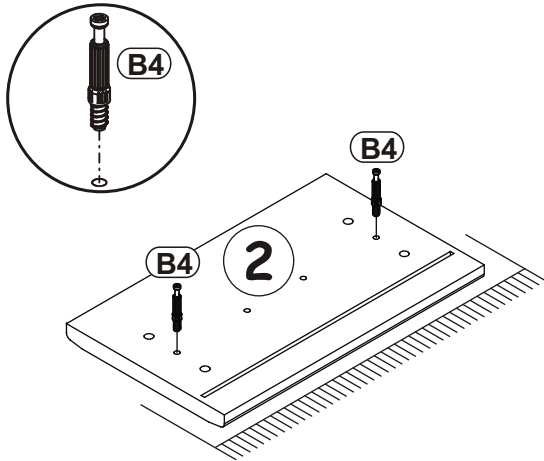
A1		B4		B5	
x4	ø8x36	x2		x2	ø15x12



6

B11		G4	
x4	Ø7x50	x4	

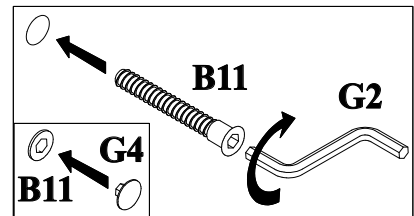
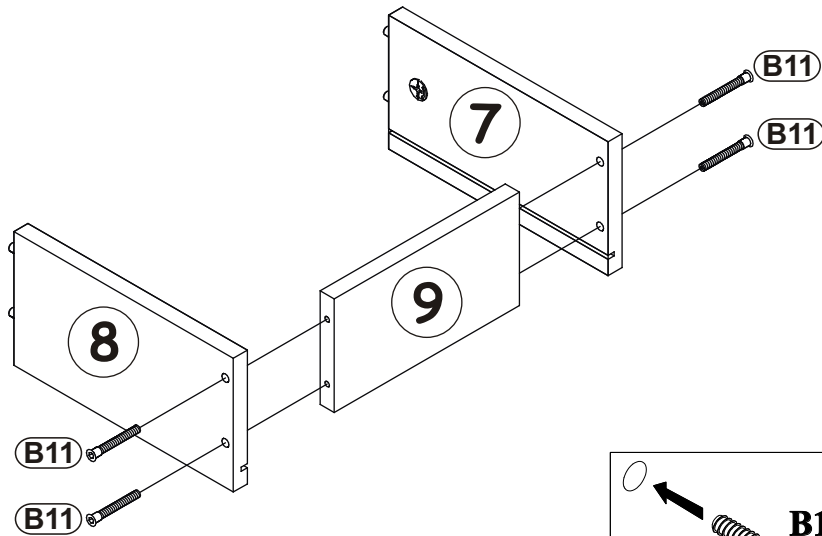

7

G5	
x2	

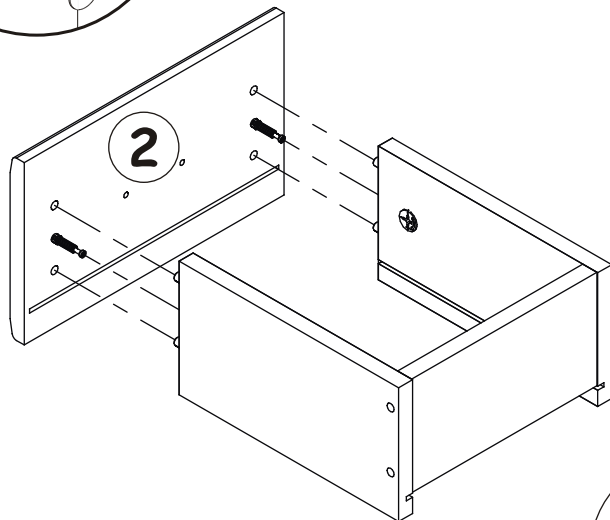
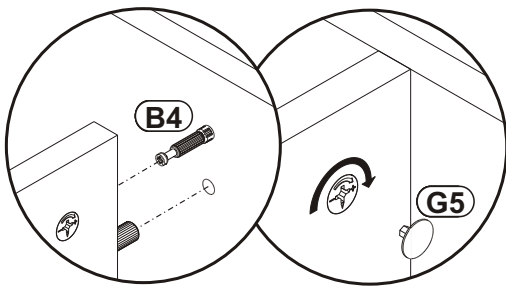

180°

8

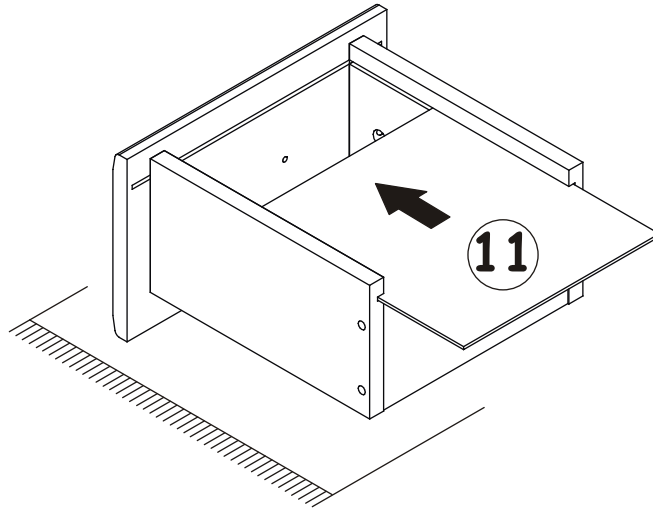

9

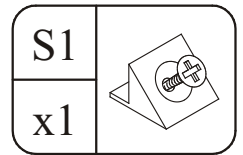
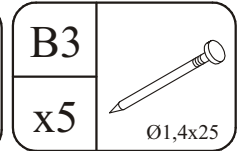
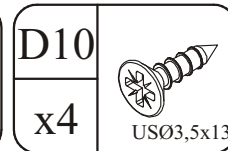
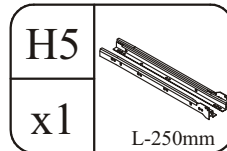
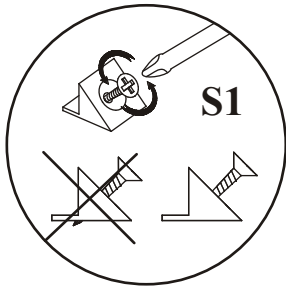

X=Y 90°

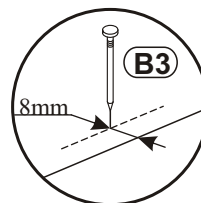
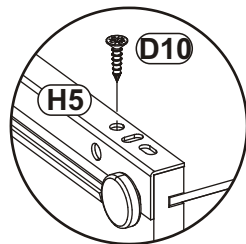
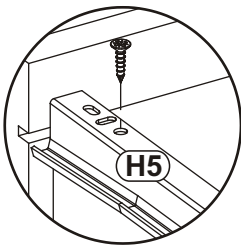
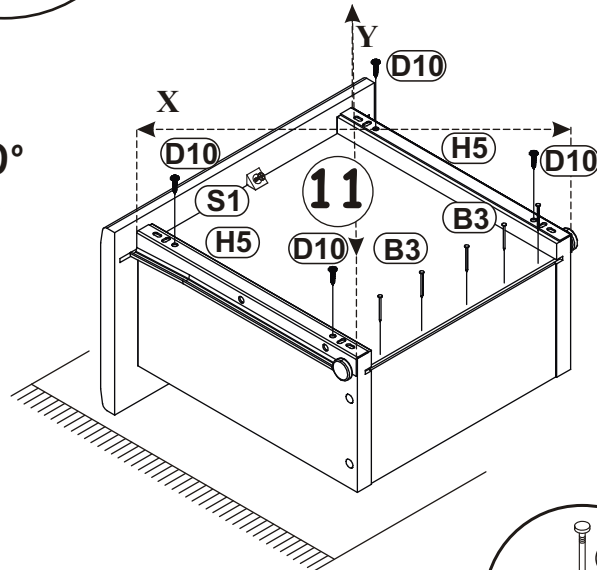

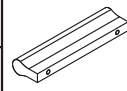
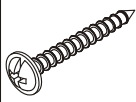

180°

10

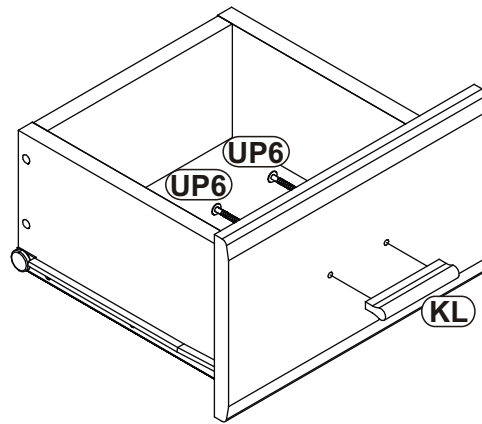
KL		UP6	
x1	L-64mm	x2	UPØ4x30



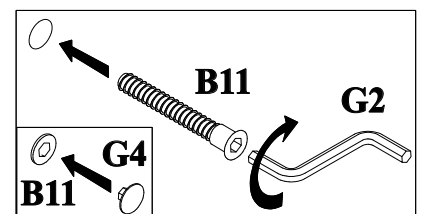
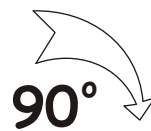
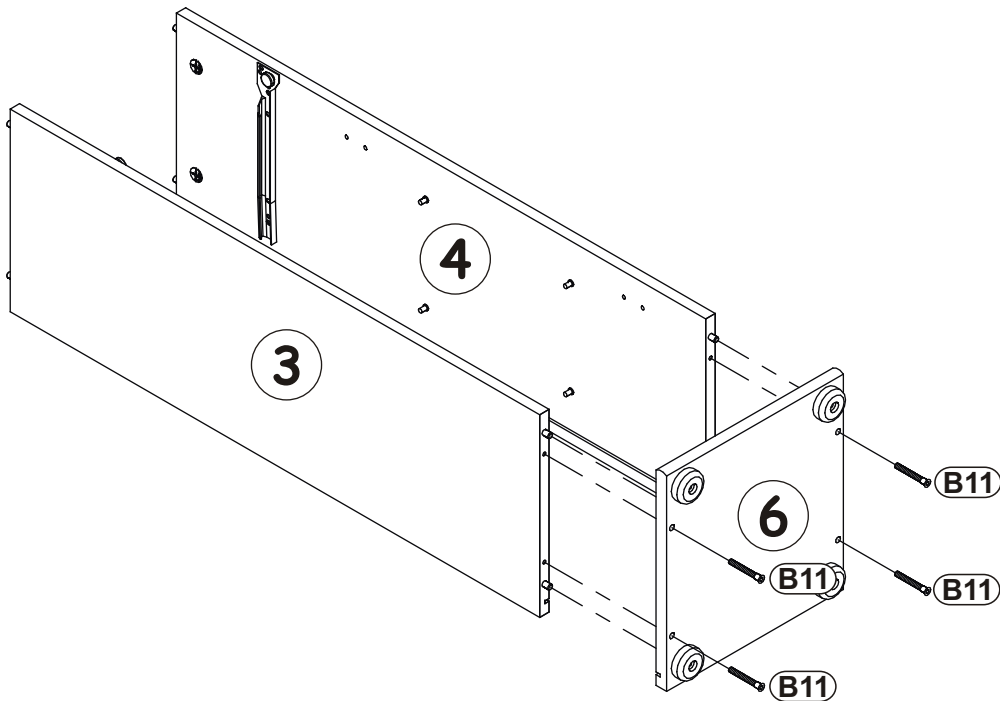

11

B11		G4	
x4	Ø7x50	x4	

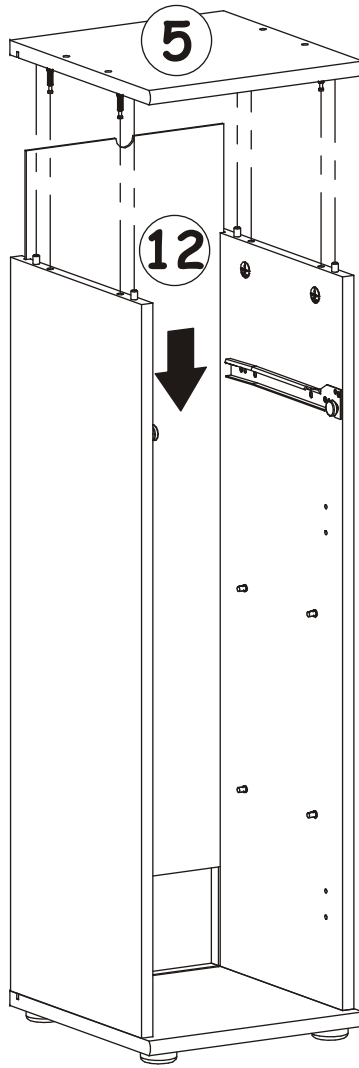

12



G5	
x4	

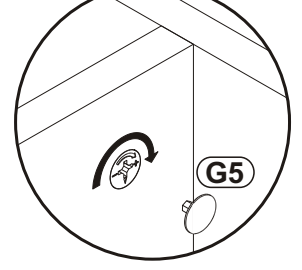
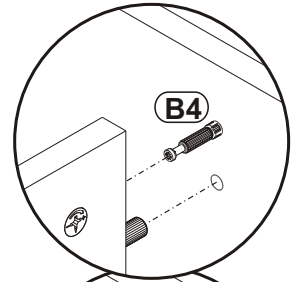

13

$X=Y$ \uparrow 90°

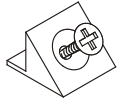
S1	
x8	

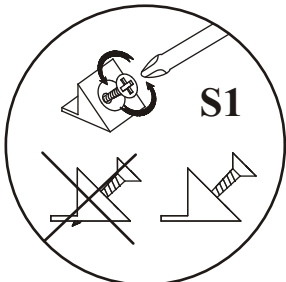
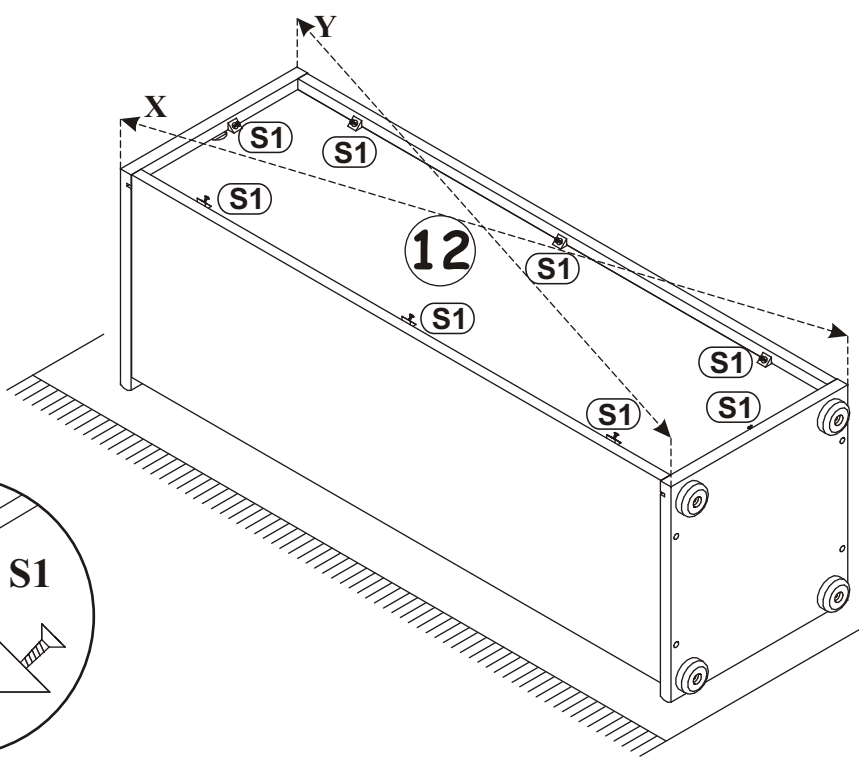

14

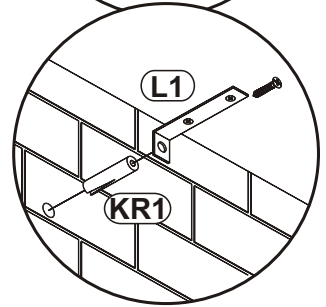
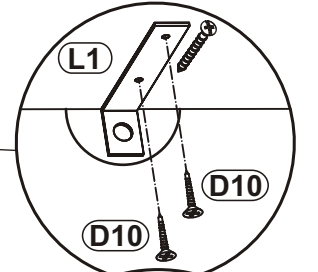
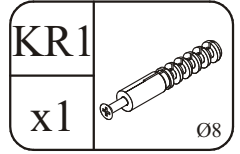
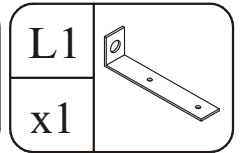
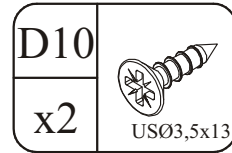
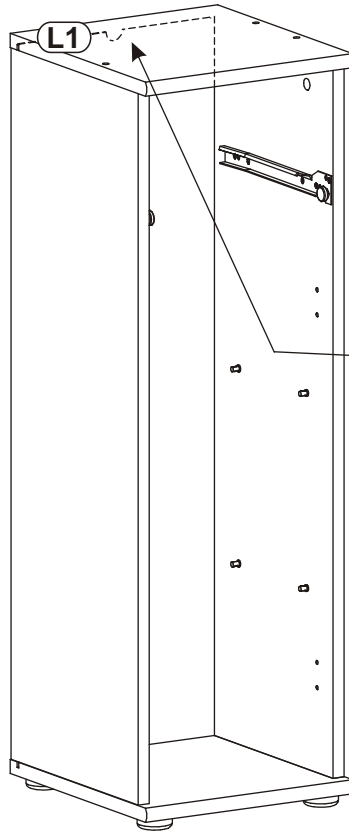
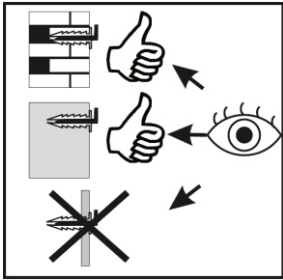
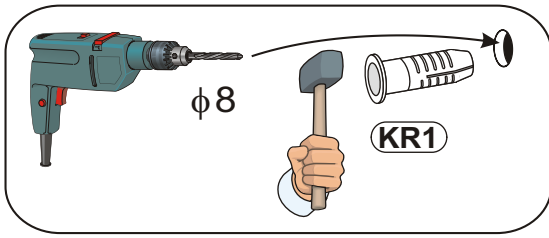

15

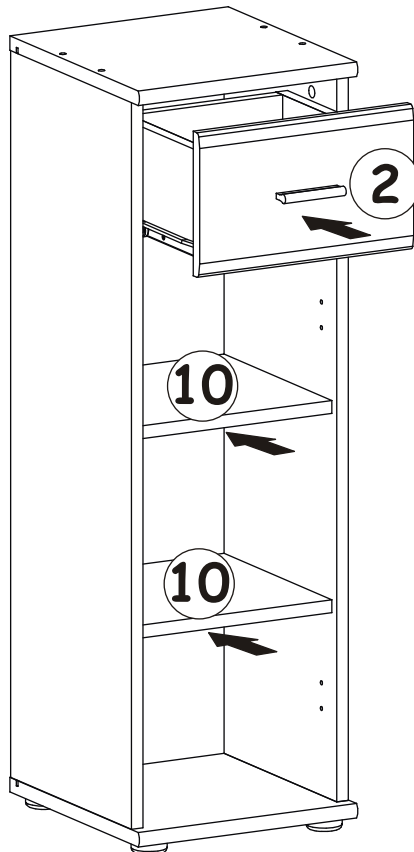
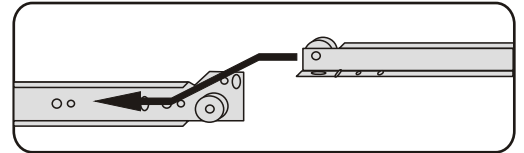

16-19

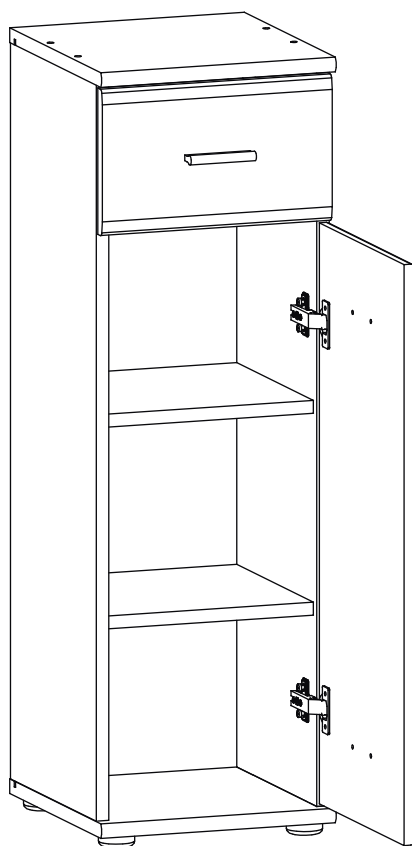

20-23

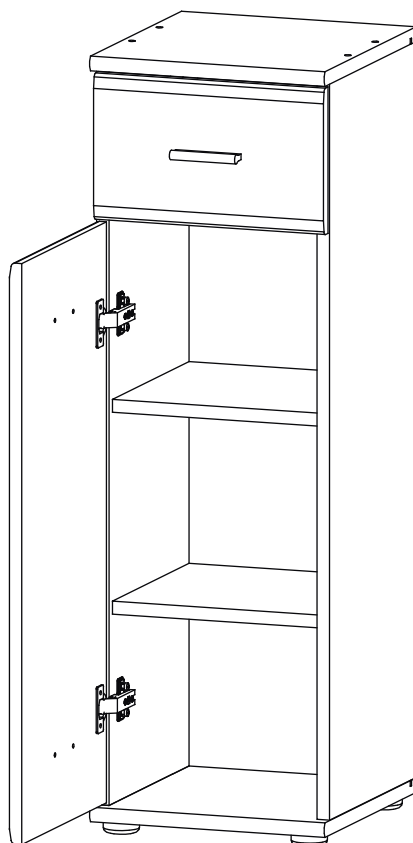

16

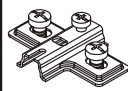
E2	
x2	H=0

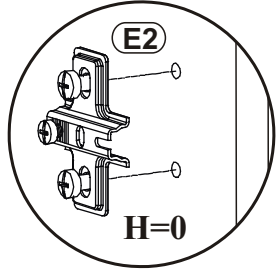
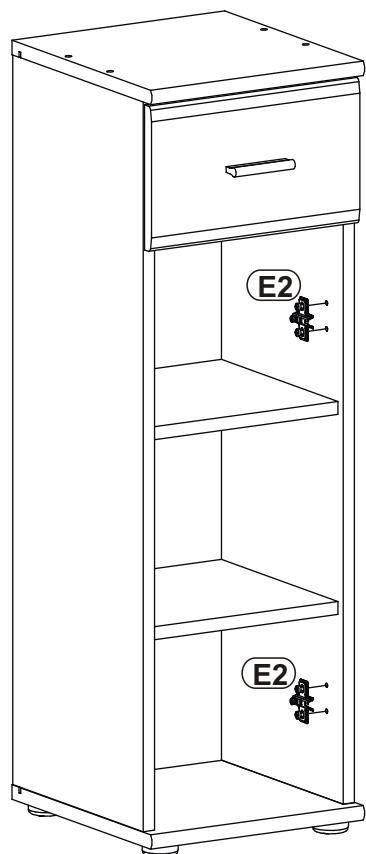
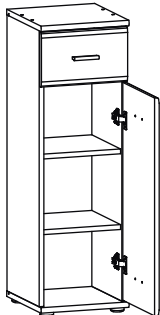

17

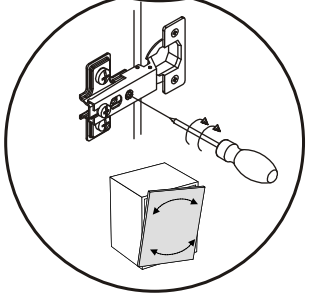
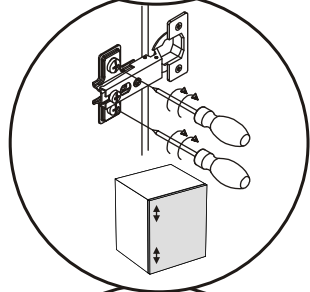
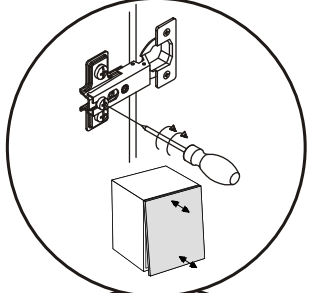
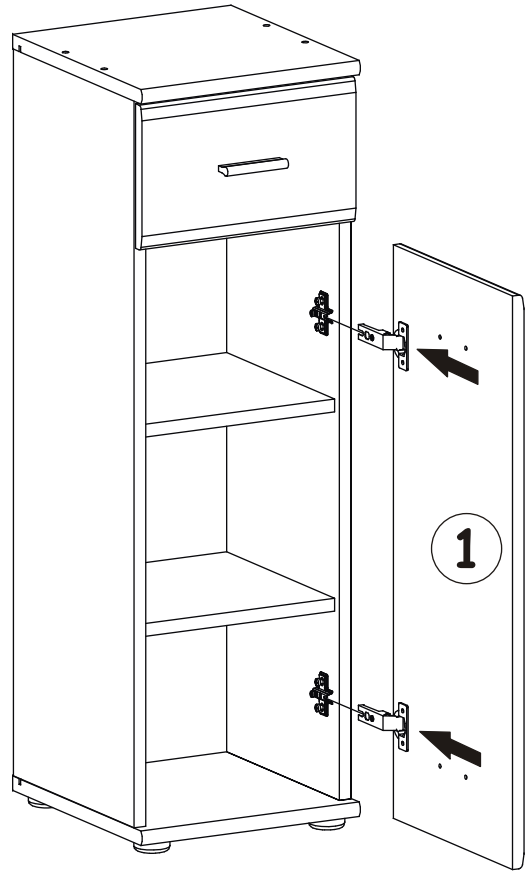

18

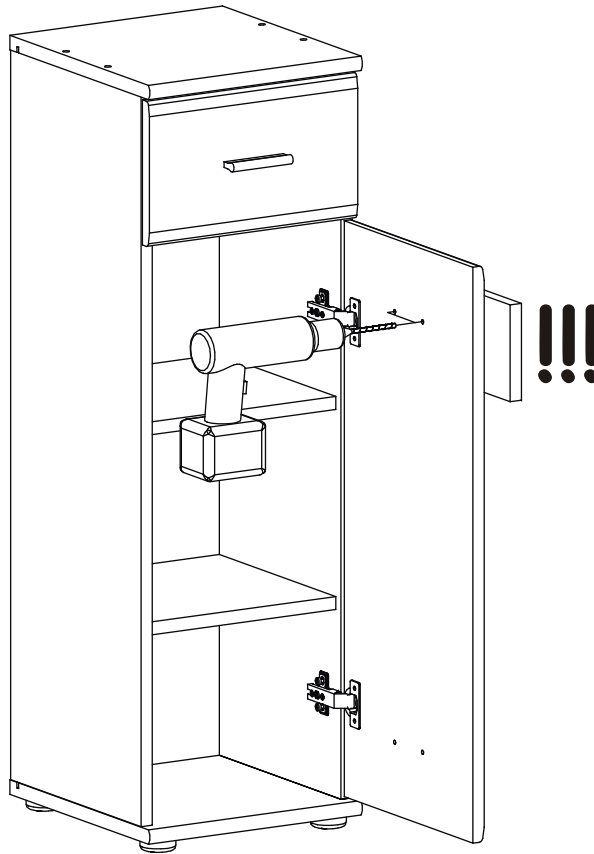
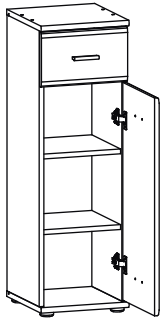

19

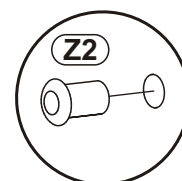
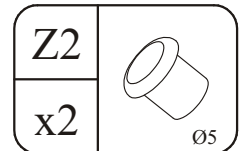
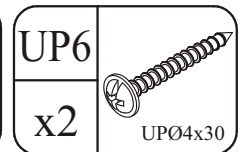
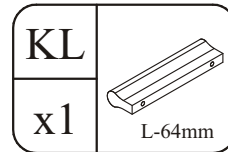
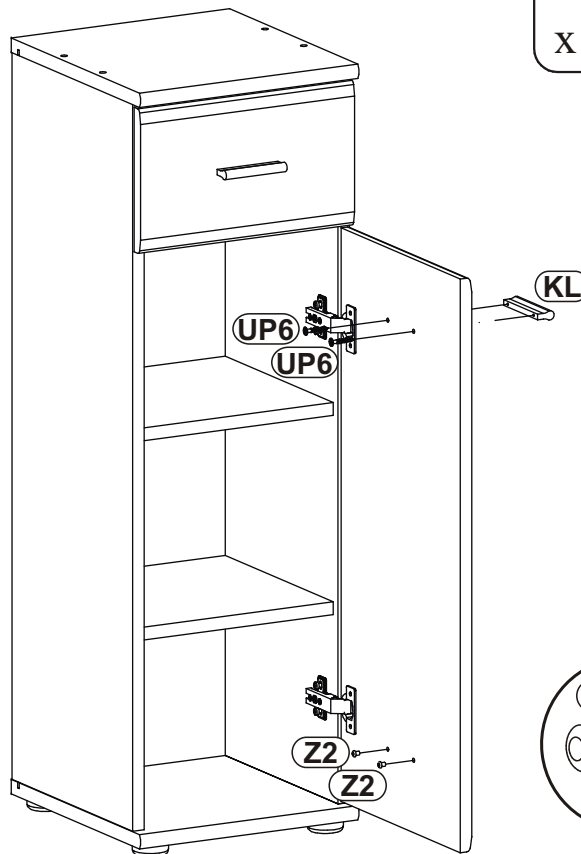

20

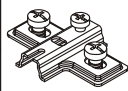
E2	
x2	H=0

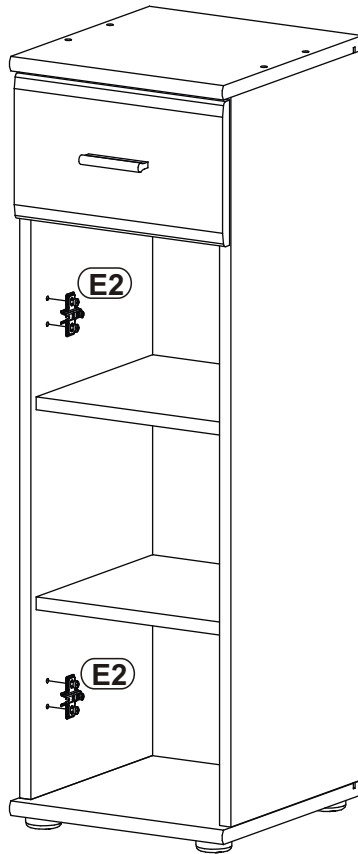
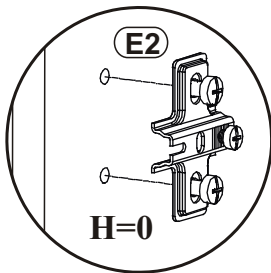
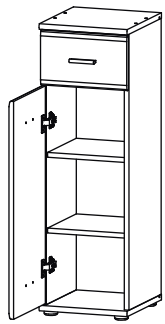

21

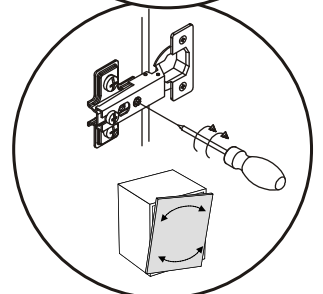
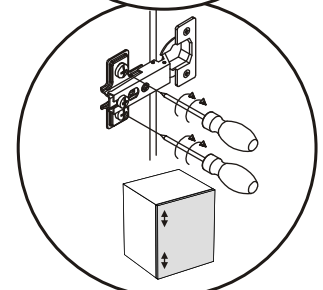
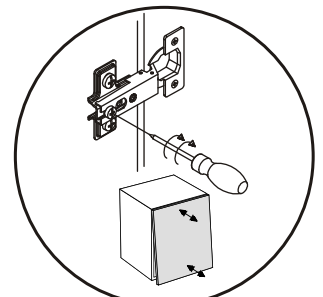
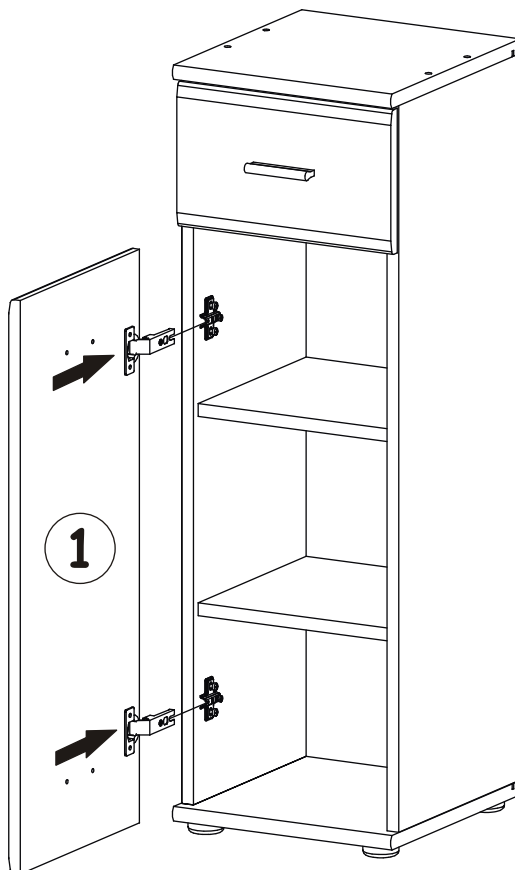

ARMARIO 1 ECO TYP B

22

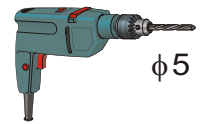
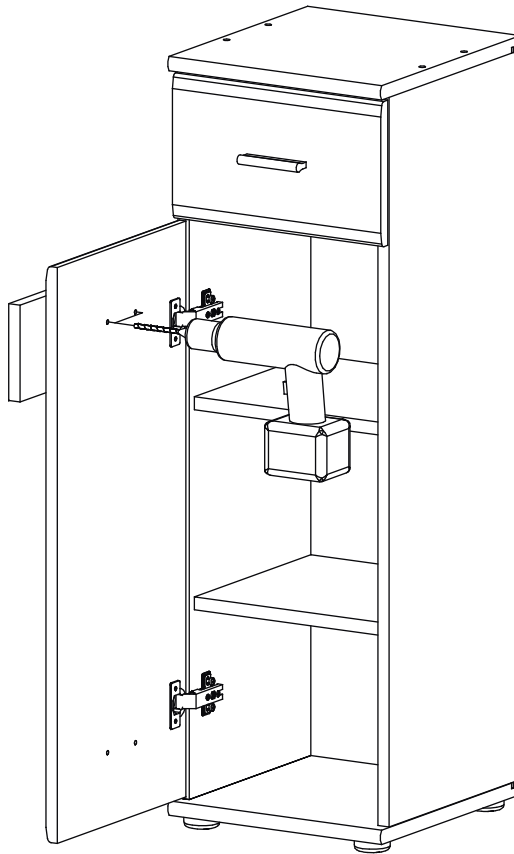
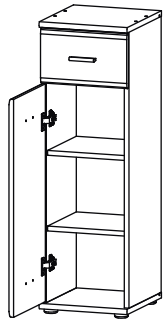

23

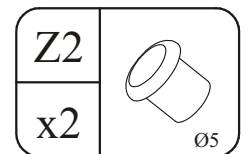
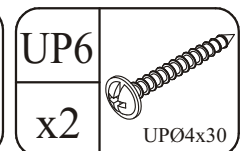
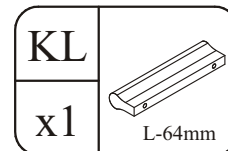
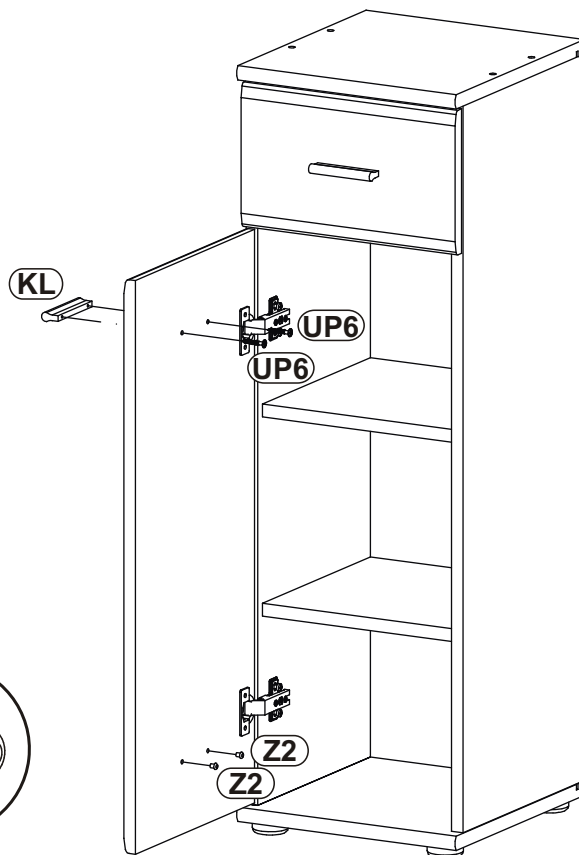



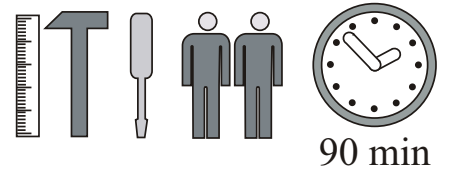
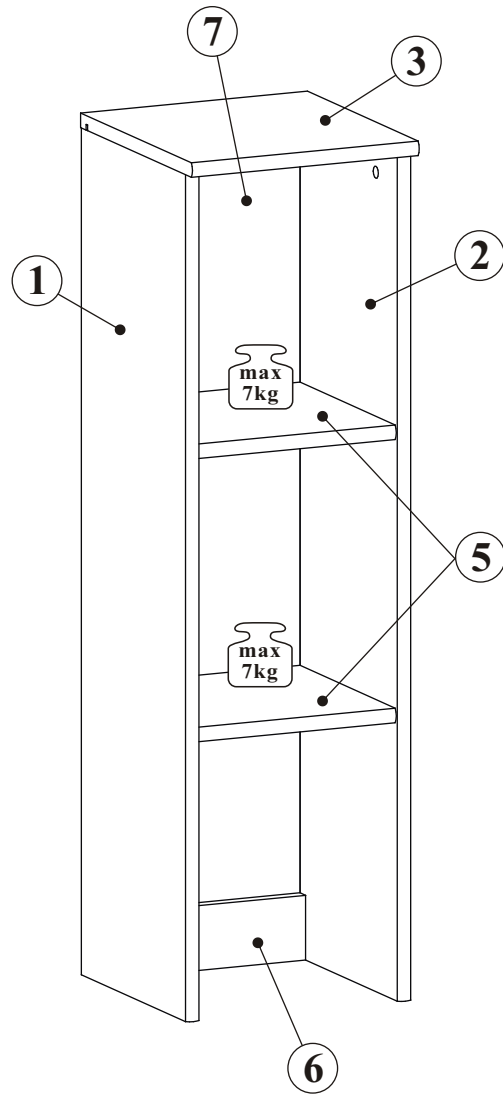
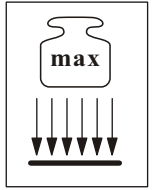
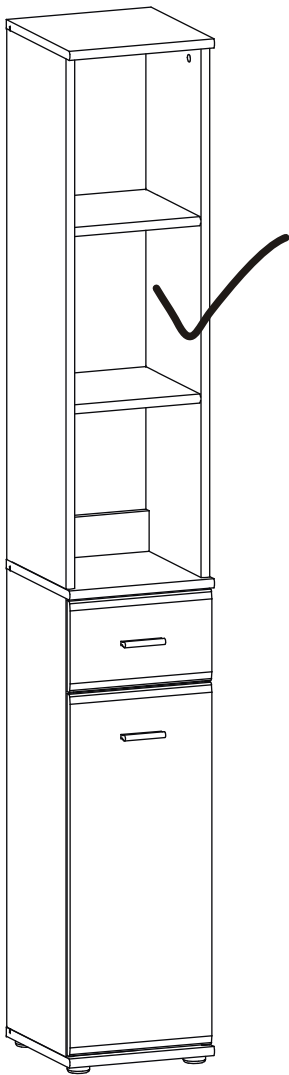





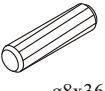
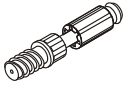

ARMARIO 1 ECO TYP C

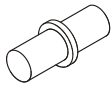

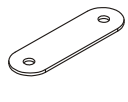
90 min

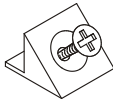
NO	Dim.			Col.-No	Qty
1	1047	303	18	1	1
2	1047	303	18	1	1
3	302	322	18	1	1
5	264	277	18	1	2
6	264	80	16	1	1
7	1004	275	3	1	1

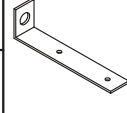
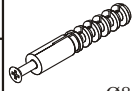

ARMARIO 1 ECO TYP C

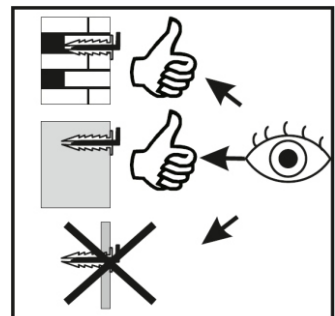
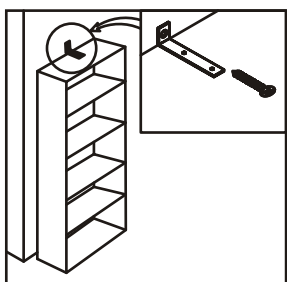
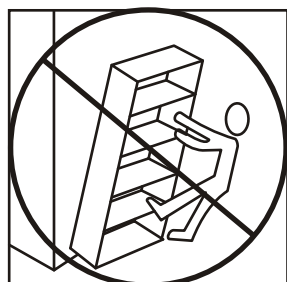
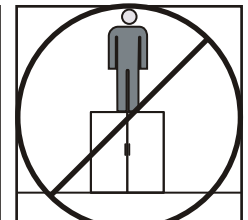
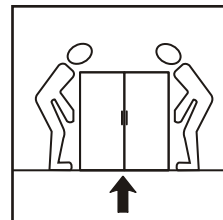
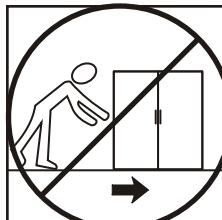
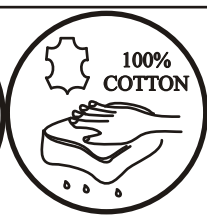
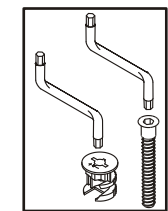
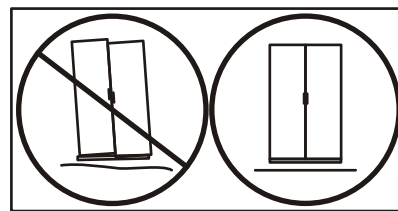
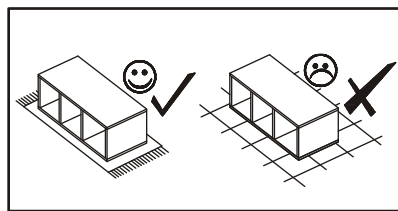
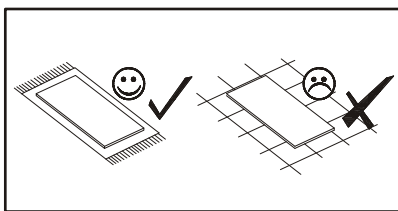
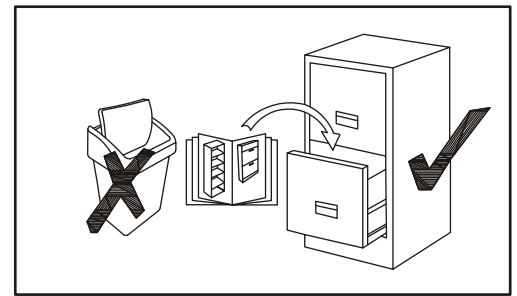
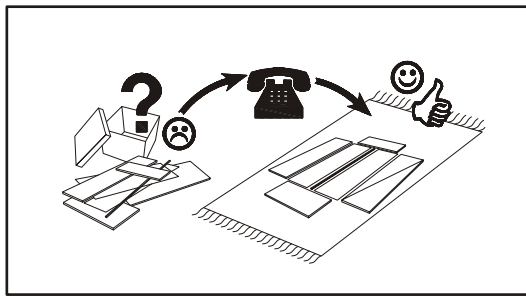
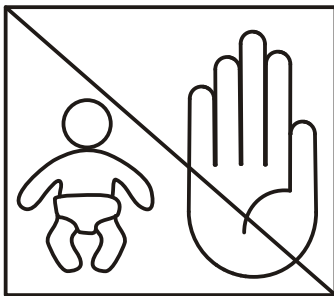
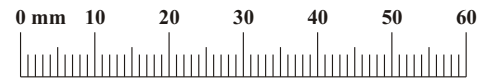
A1 x10  ø8x36	B4 x6 	B5 x6  ø15x12	G5 x6 	G7 x8 	D10 x2  USØ3,5x13
MG3 x2 	D9 x4  USØ3x20	S1 x7 	UP17 x2  UPØ3x16	L1 x1 	KR1 x1  Ø8
G2 x1 					

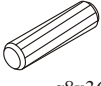

ARMARIO 1 ECO TYP C

1

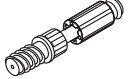
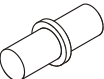
A1		B5		B4	
x8	ø8x36	x4	ø15x12	x2	
G7					
x8					

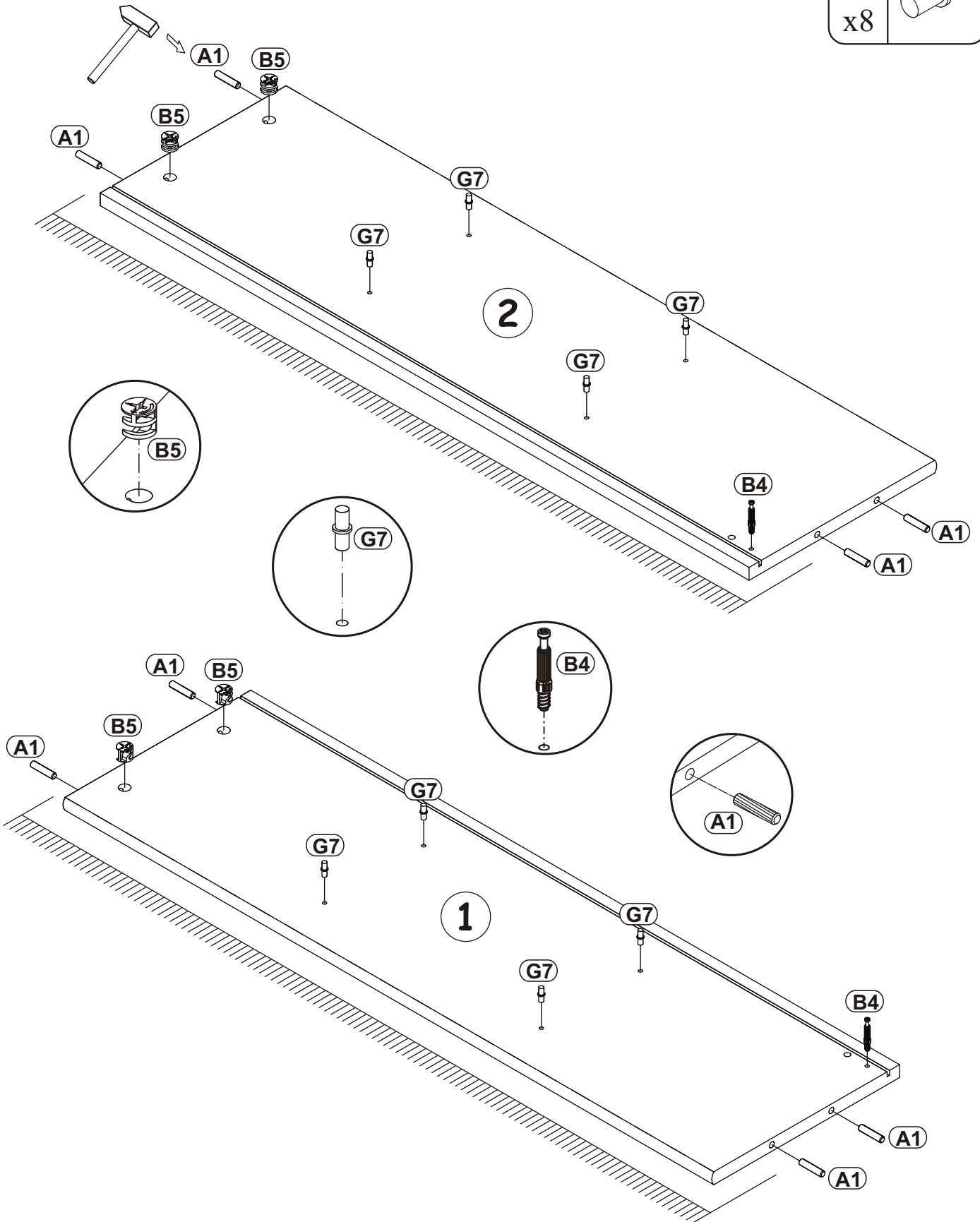

ARMARIO 1 ECO TYP C

2

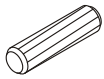
A1	
x2	ø8x36

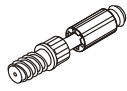
B4	
x4	

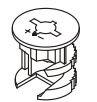
B5	
x2	ø15x12

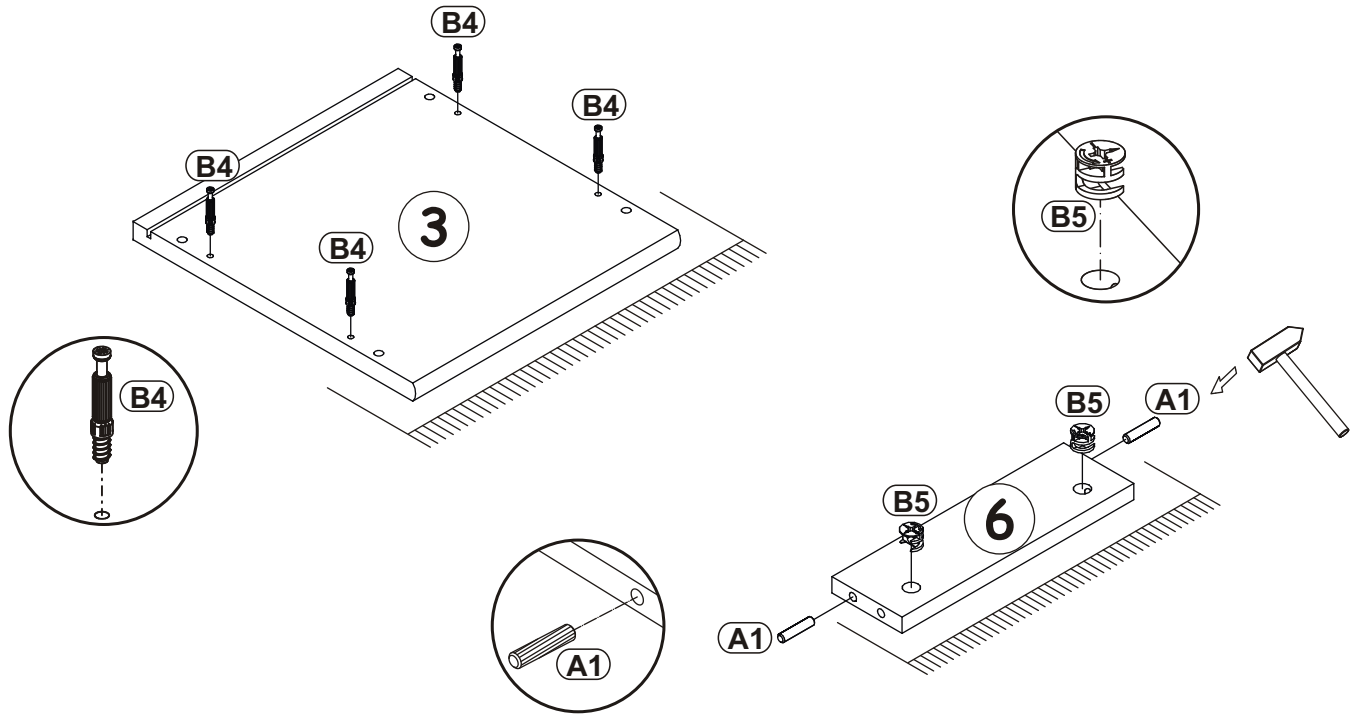

3

G5	
x2	

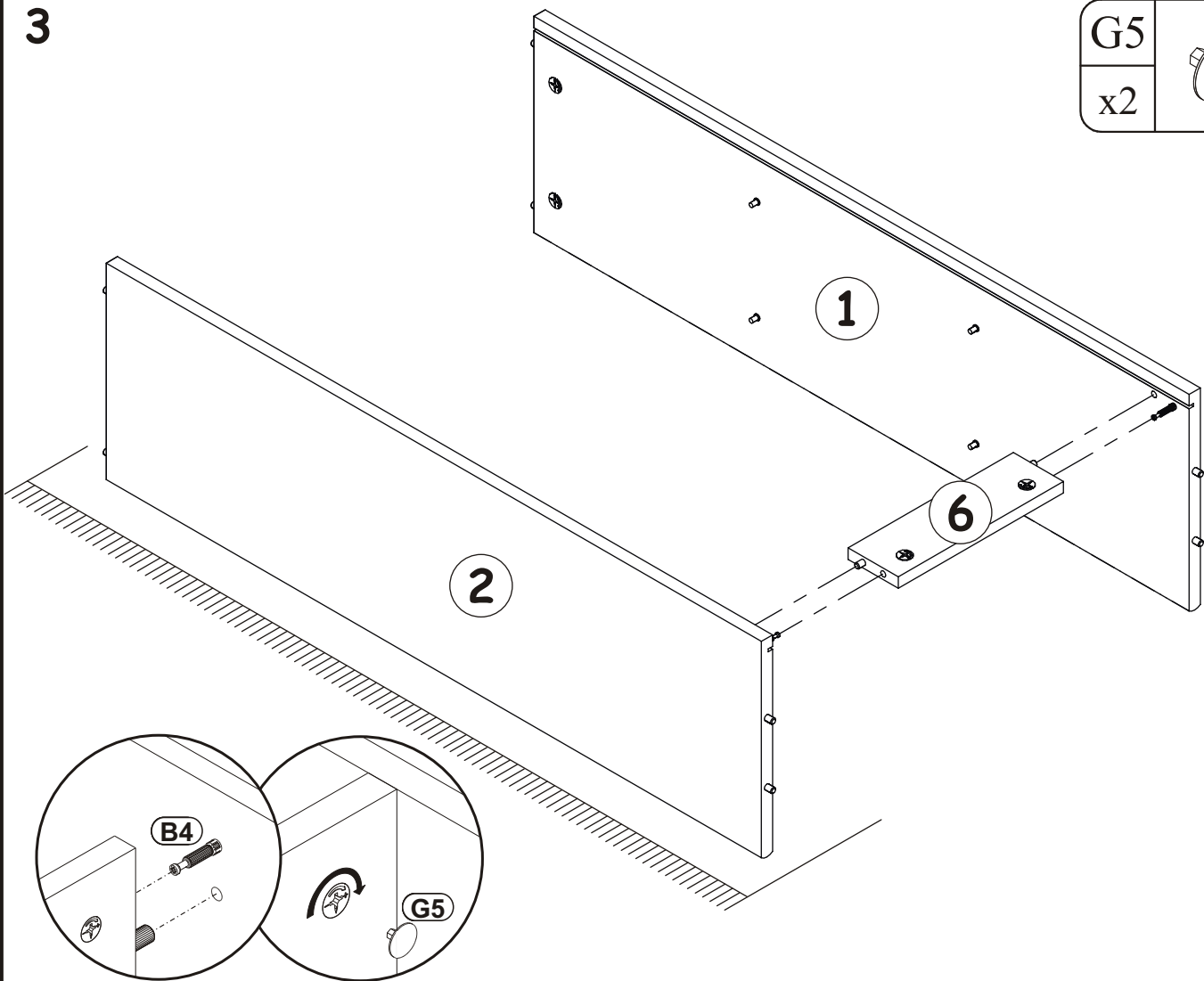

G5

x4



4

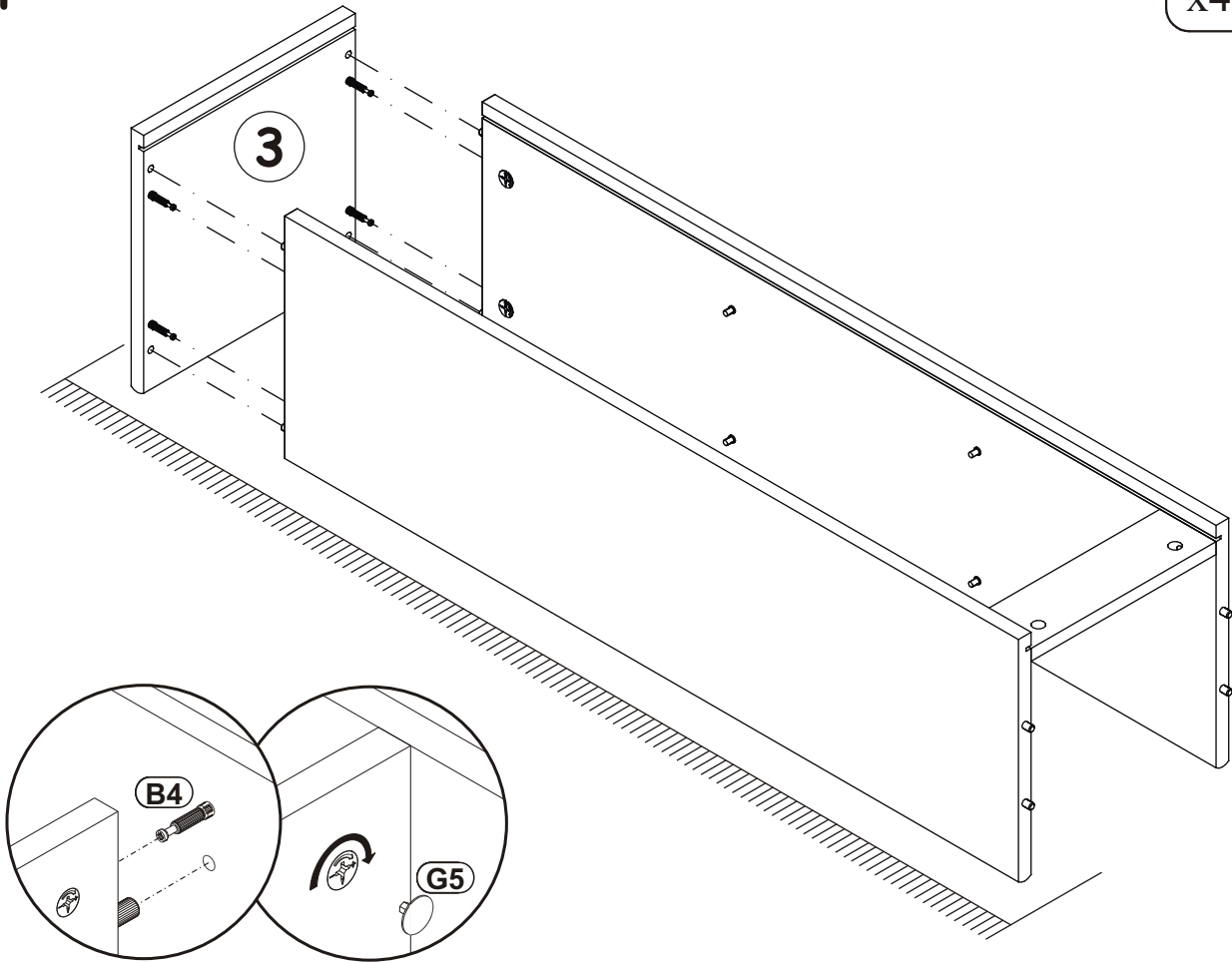

5

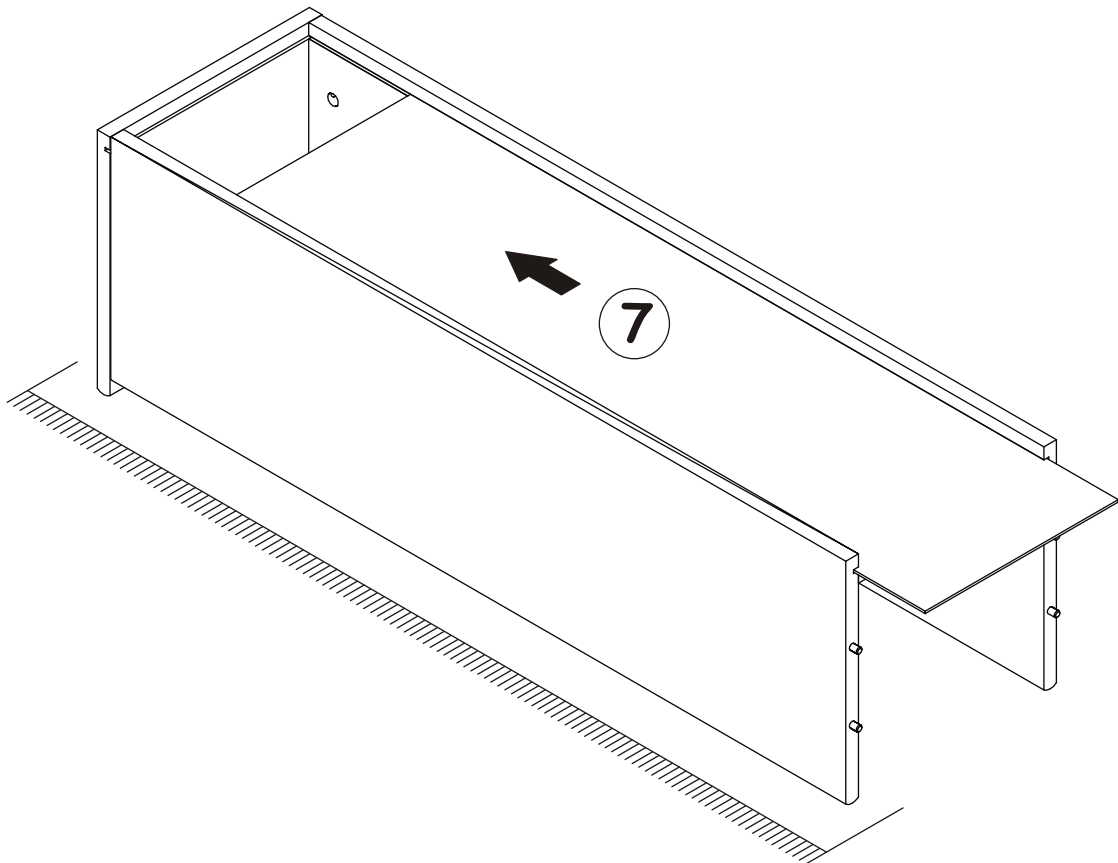

ARMARIO 1 ECO TYP C

6

$X=Y$ 90°

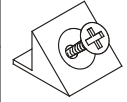
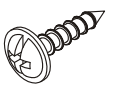
S1		UP17	
x7		x2	UPØ3x16

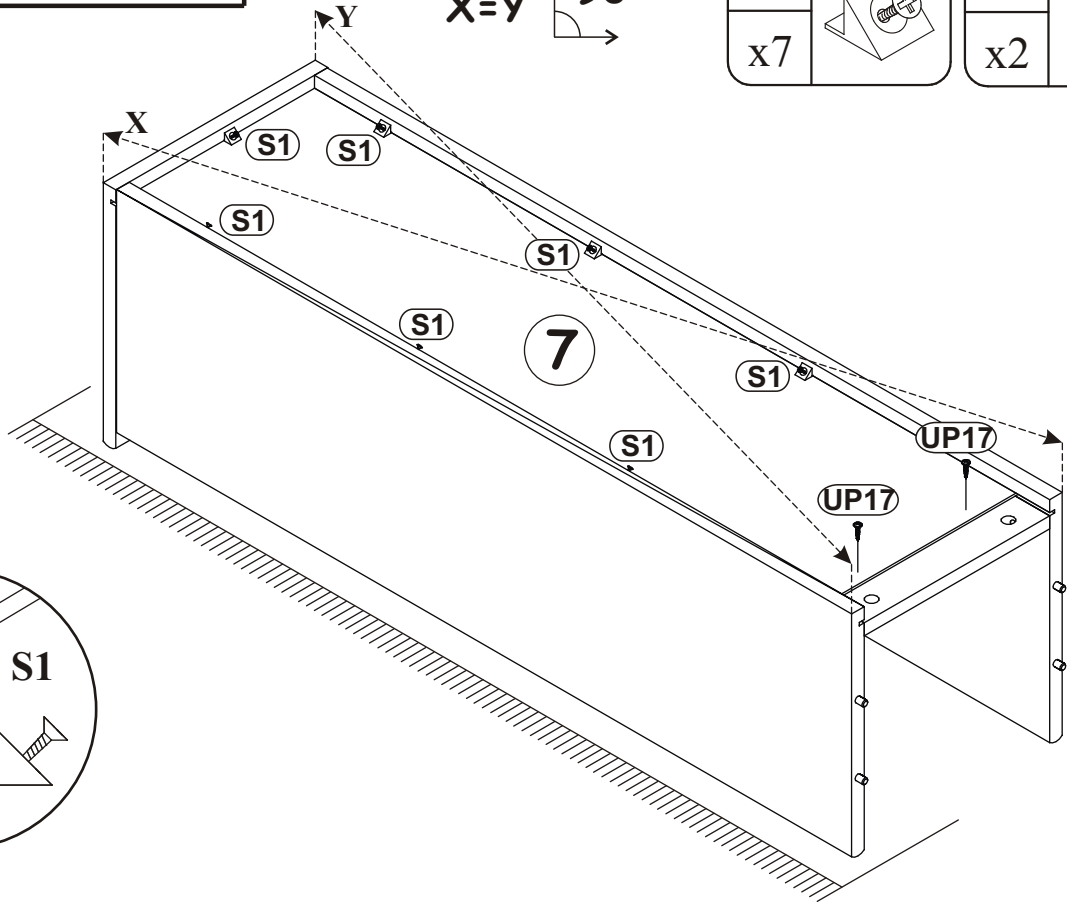
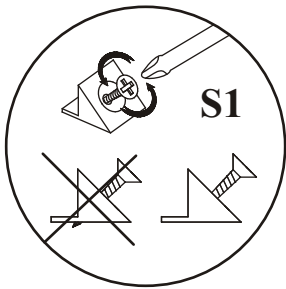

7

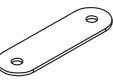
MG3	
x2	

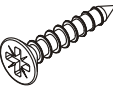
D9	
x4	USØ3x20

TYP B

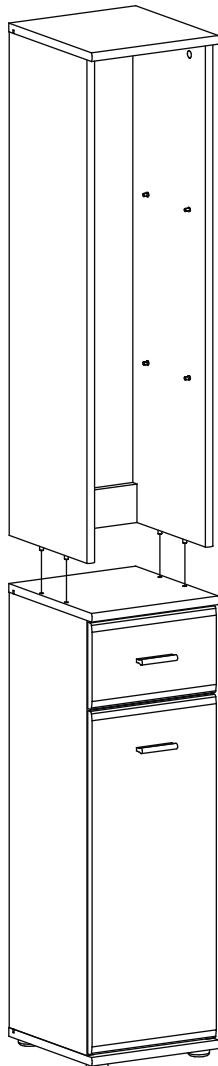

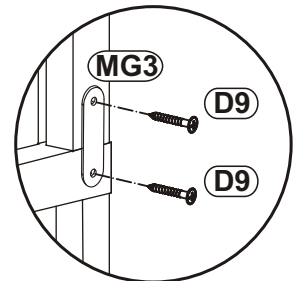
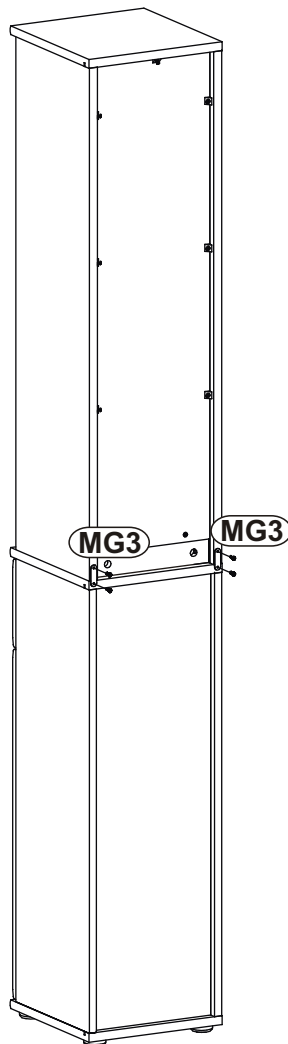

180°

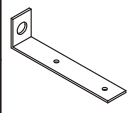

8

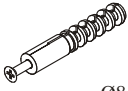
L1	
x1	

KR1	
x1	Ø8

D10	
x2	USØ3,5x13

