

DAMAR, DAMAR II, GALANT

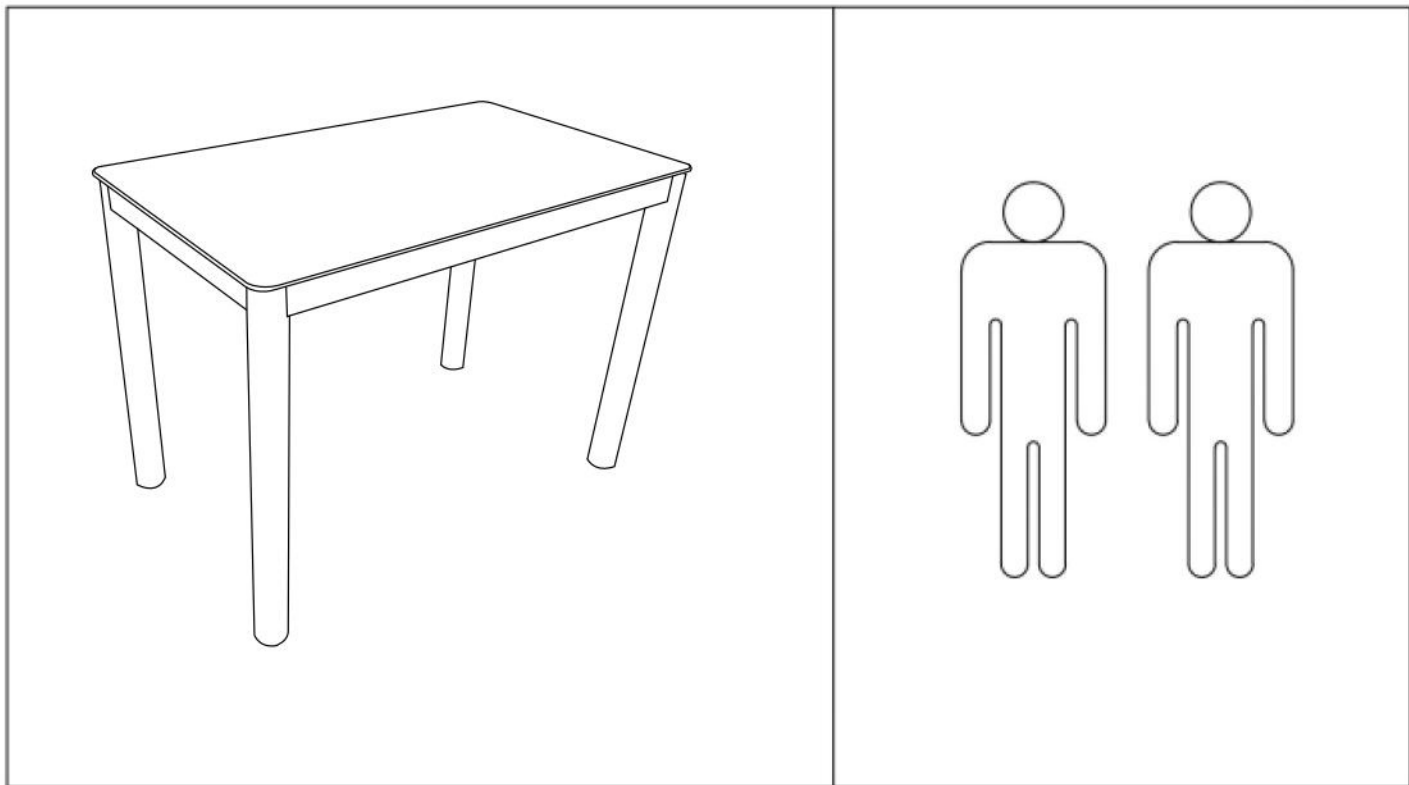

1

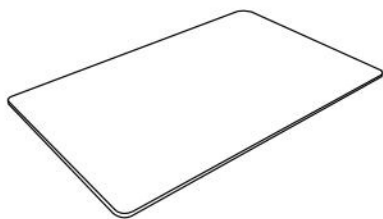



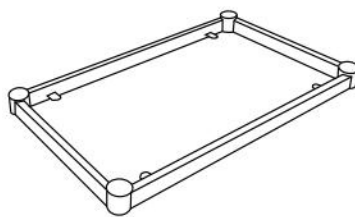





2

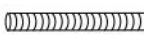

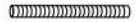
3



1	1x
2	1x
3	4x

<p>A</p>  <p>8x35 4</p>	<p>B</p>  <p>8mm 8</p>	<p>C</p>  <p>10x60 4</p>	<p>D</p>  <p>10mm 4</p>	<p>E</p>  <p>8x22 4</p>	<p>F</p>  <p>60Ø 4</p>	<p>G</p>  <p>6</p>	<p>H</p>  <p>1</p>
--	---	---	--	--	---	---	---

DAMAR, DAMAR II, GALANT

①

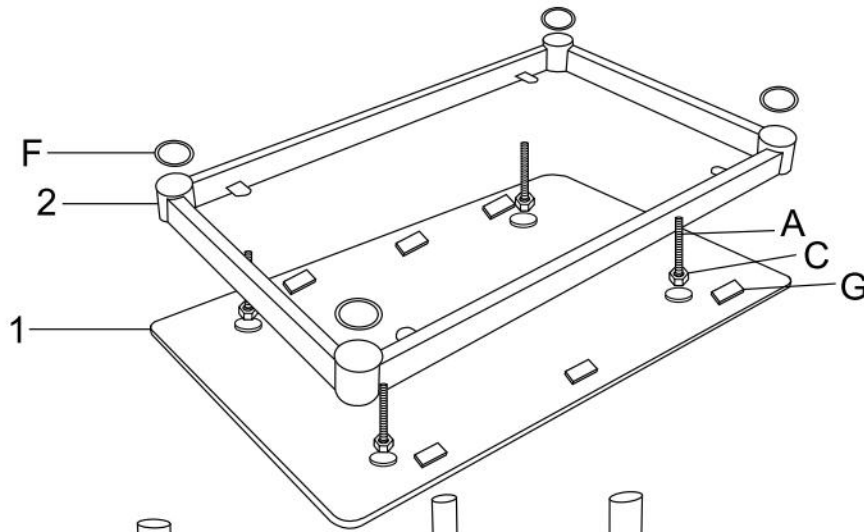
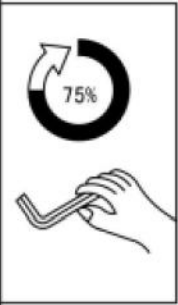

②

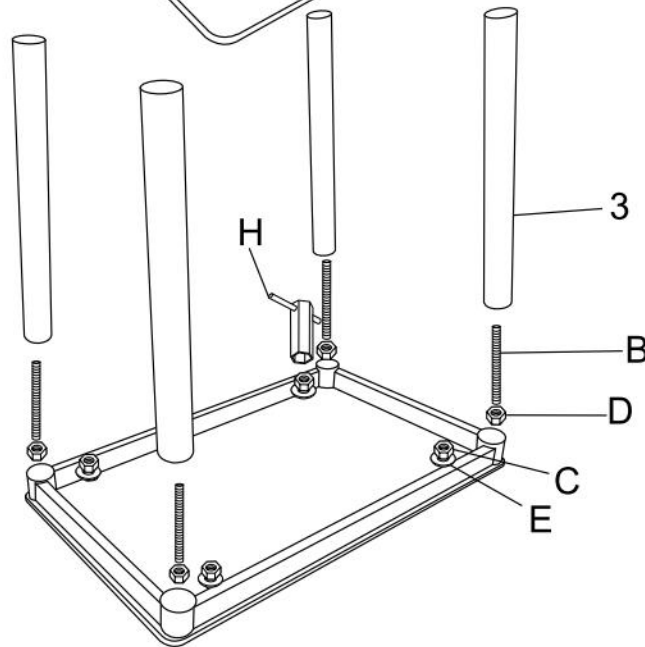
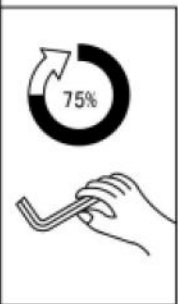

②

