

# -778-1

# -792-1

# -7110-1

Montageanweisung / Installation instructions / Instruction de montage / Istruzioni di montaggio  
montagehandleiding / Instrukcja montazu / Montaj talimatlar / Osszeszerelési útmutatót / Nàvod k montázi /  
Nàvod na montaz / Instructiune de montaj / Инструкция по монтажу Montaj talimatina / Monteringsanvisningar  
Upute za montažu / Instrucciones de Montaje / Navodila za montažo

## DAMA

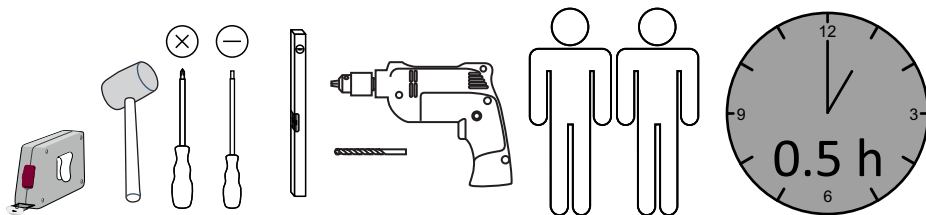

VITTORIA-START-  
JUPITER

78-92 cm.

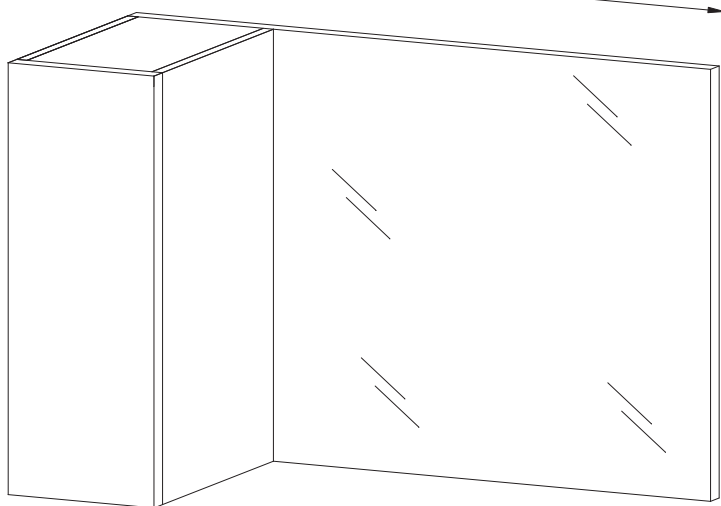

110 cm.

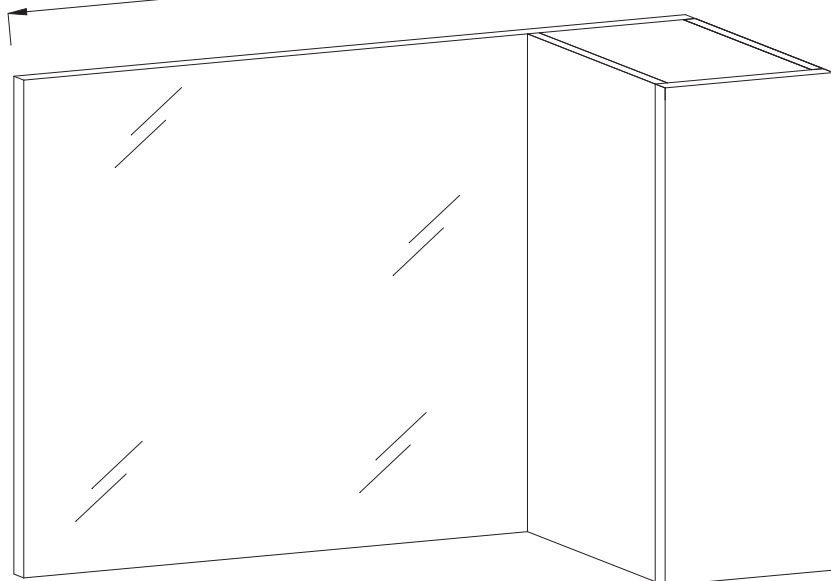

**D** – bitte lesen sie diese montageanleitung gut durch,  
Da wir für fehler, die durch falsche montage entstehen,  
Keine haftung übernehmen!

**Gb** – please read these installation instructions  
Through carefully as we cannot accept any liability  
For faults occurring as a result of incorrect installation!

**Cz** – přečtěte si prosím pozorně tento návod k montáži,  
Aby jste předešli chybám vzniklých špatnou montáží,  
Za které neručíme!

**F** – veuillez lire attentivement cette notice de montage,  
Car nous déclinons toute responsabilité en cas d'erreurs  
Découlant d'un montage erroné !

**I** – prego leggere attentamente le istruzioni per il montaggio,  
Poiché decliniamo qualsiasi responsabilità  
Per difetti derivanti da montaggio errato.

**S** - läs monteringsanvisningarna noggrant.  
Vi avsåger oss allt ansvar för defekter som  
Uppstår p.g.a. Felaktig montering.

**Hr** – pažljivo pročitajte upute za montažu,  
Jer otklanjamo svaku odgovornost za pogreške  
Nastale uslijed pogrešne montaže.

**Slo** – prosimo, da pozorno preberete navodila za montažo,  
Saj zavračamo vsakršno odgovornost za napake,  
Ki bi nastale zaradi napačne montaže.

**NI** – leest u alstublieft deze montagehandleiding goed door,  
Voor fouten door verkeerde montage zijn wij niet verantwoordelijk.

**PI** – prosze uwaznie zapoznac sie z instrukcja montazu,  
Poniewaz nie ponosimy odpowiedzialnosci za niewlasciwy montaz.

**HU** – Kérjük, olvassa el figyelmesen  
ezt az összeszerelési útmutatót,  
mert a helytelen összeszerelésből  
a dódó hibákért nem vállalunk felelősséget!

**SK** – Prosíme, dobre prečítajte si tento návod na montáž,  
pretože nepreberáme žiadne ručenie za chyby,  
ktoré vzniknú na základe chybnej montáže!

**RO** – Vă rugăm să cititi cu atenție aceste instructiuni  
de montaj deoarece nu preluăm garanția pentru defecte  
ce apar datorită unui montaj incorect!

**RUS** – Пожалуйста, внимательно ознакомьтесь ù  
с данной инструкцией по монтажу, поскольку мы не  
несем ответственности за ошибки, причиной которых  
является неправильный монтаж.

**TU** – İlkonce kullanma klavuzunu iyi okkuyun,  
yalnis montaj yapasaniz bunun sorumlusu biz degiliz.

**ES** – Se ruega leer con atención las instrucciones  
de montaje debido a que declinamos cualquier  
responsabilidad  
por defectos derivados de un montaje erróneo.

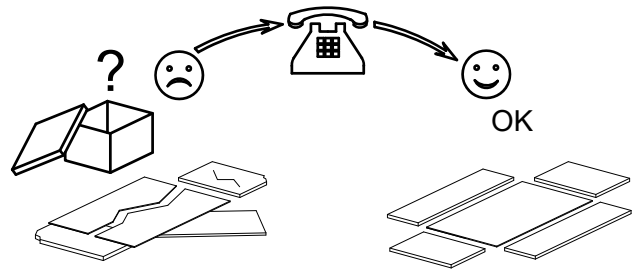
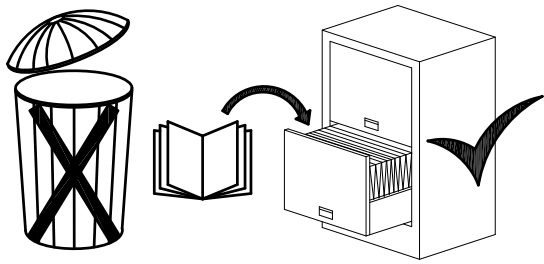

7110PAT = 110cm.

792PAT = 92cm.

778PAT = 78cm.

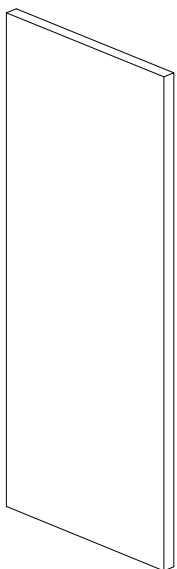
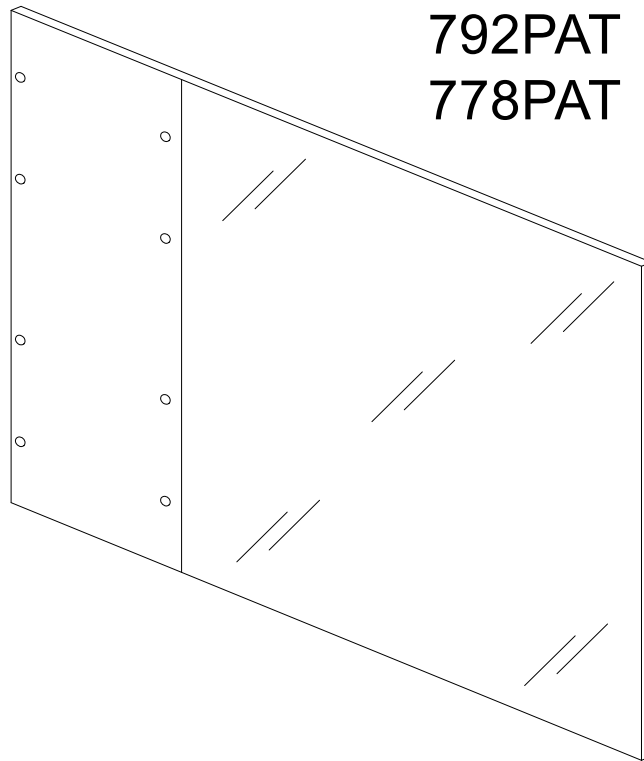

7110PCI

7110PFI

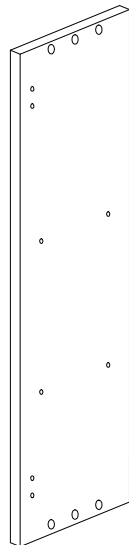

7110PCI

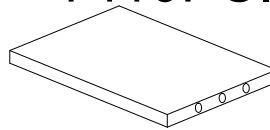



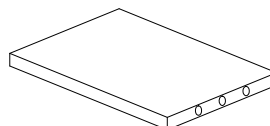
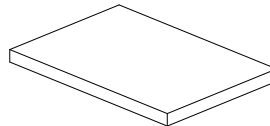

7110PPI x2

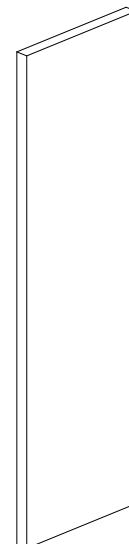

7110PCI

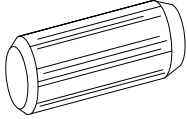
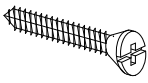
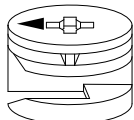

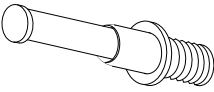
7110PFI

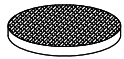
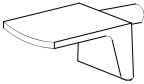
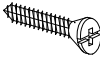
<b>B</b>		8x30 mm.	<b>x8</b>	<b>V3535</b>		3.5x35 mm.	<b>x8</b>
<b>C</b>		ø14 x 12 mm	<b>x4</b>	<b>P</b>			<b>x2</b>
<b>D</b>			<b>x4</b>	<b>P20</b>			<b>x4</b>
<b>F3</b>			<b>x2</b>	ø20 mm.	<b>R</b>		<b>x8</b>
				<b>L416</b>		4x16 mm.	<b>x4</b>

**ATT**

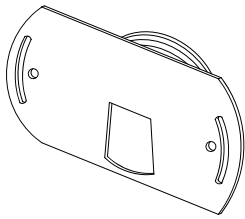

**x2**

**L15**



4x15 mm.

**x4**

**N1**

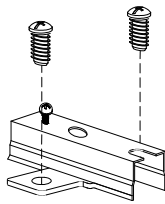

**x2**

**C0**

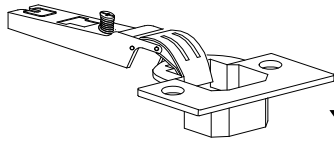

**x2**

N1

X2

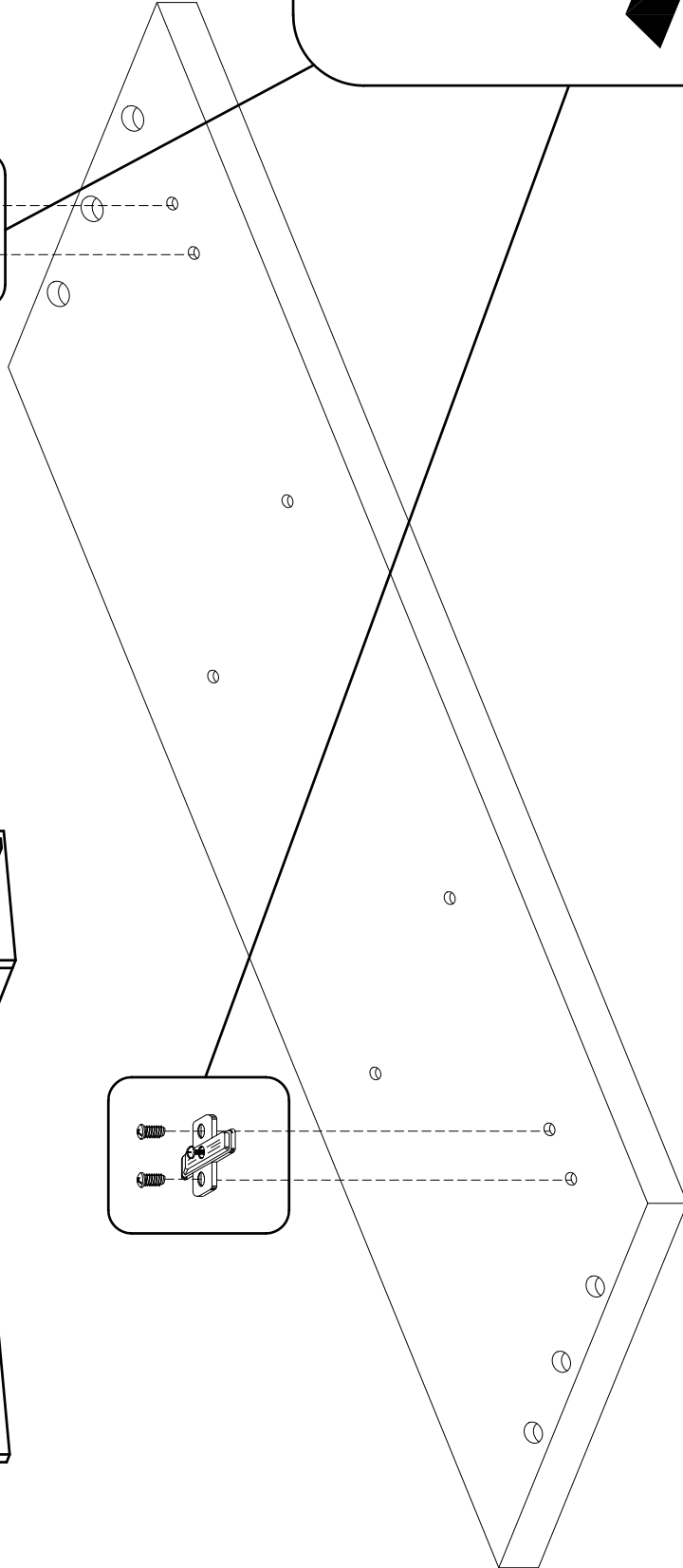
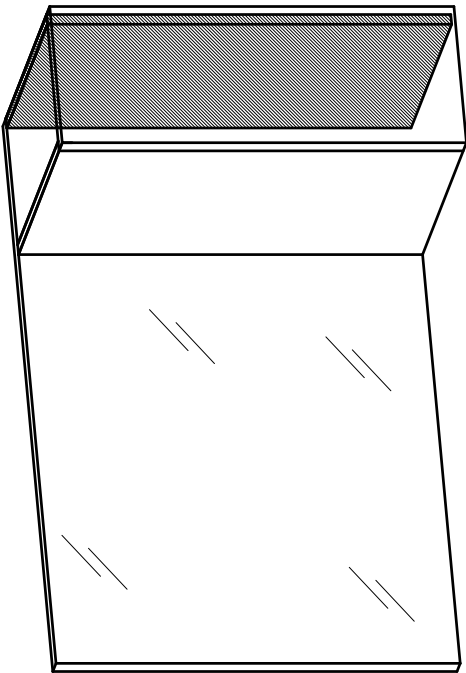
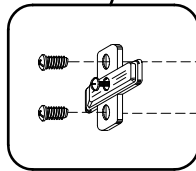
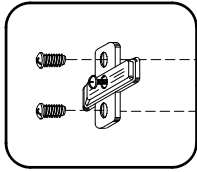
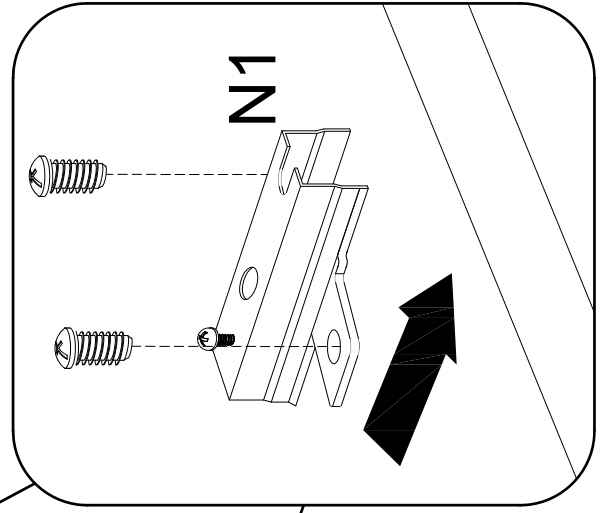
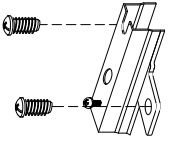

1

# 2

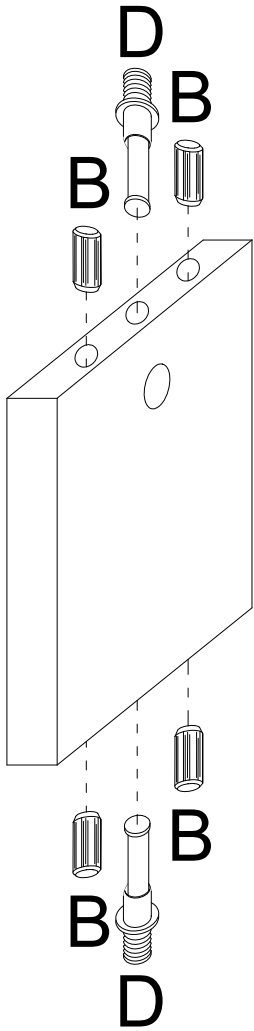

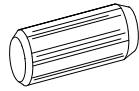

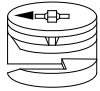

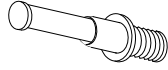
**B**  8x30 mm. **x8**

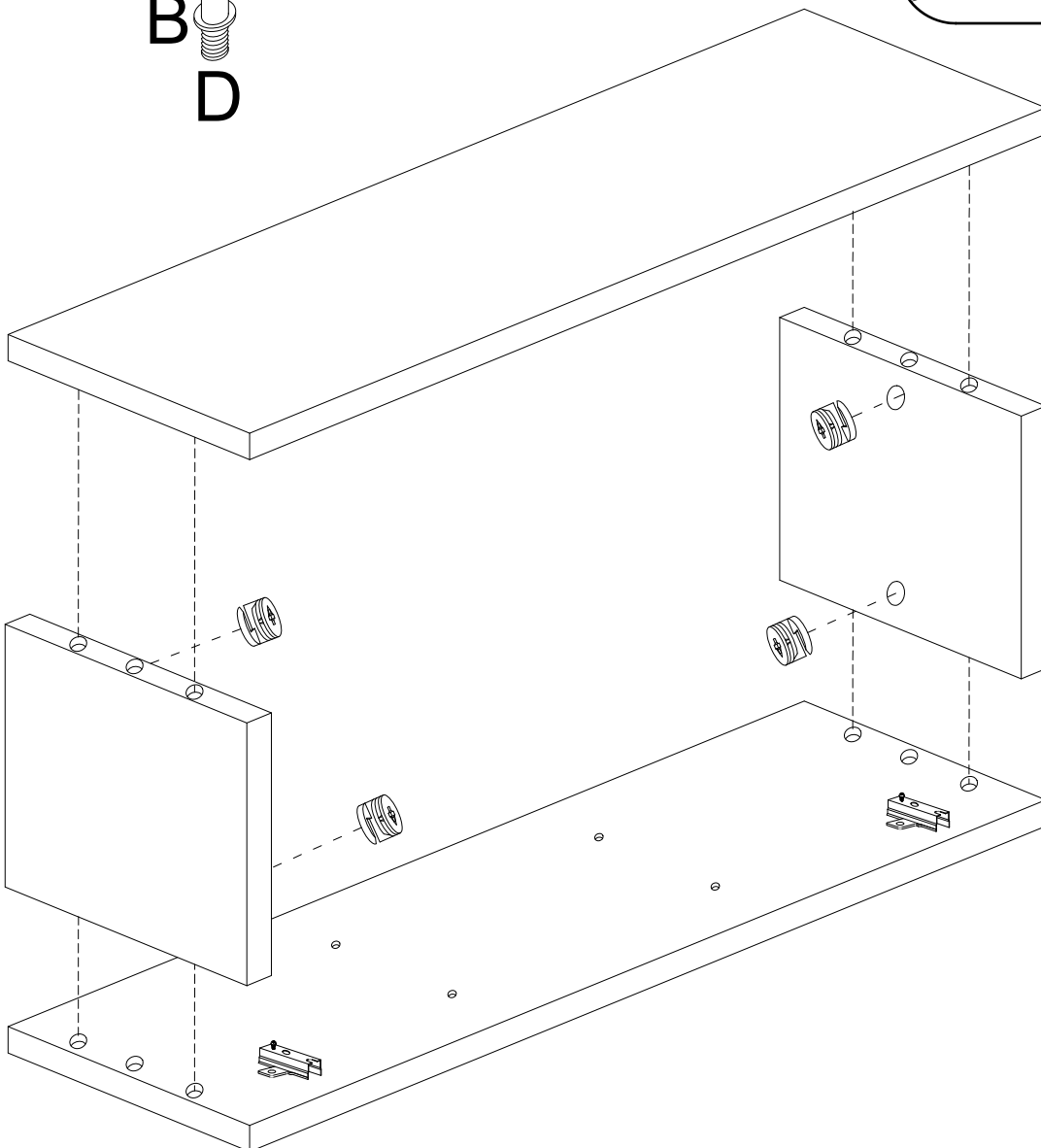
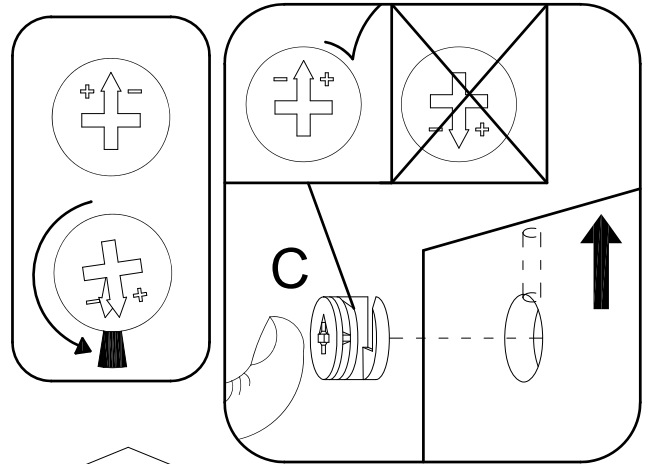
**C**   $\varnothing 14 \times 12$  mm **x4**

**D**  **x4**



3

- F3  X2
- V3535  X8  
3.5x35 mm.
- L416  X8  
4x16 mm.
- ATT  X4

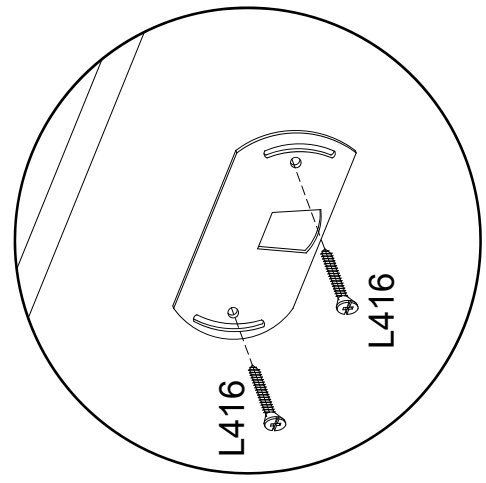
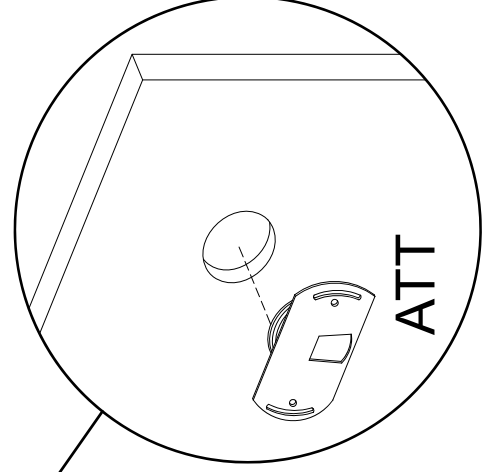
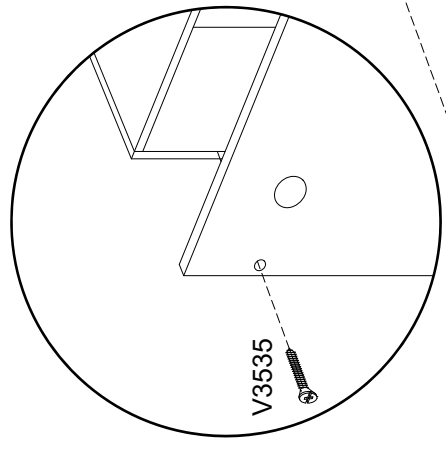
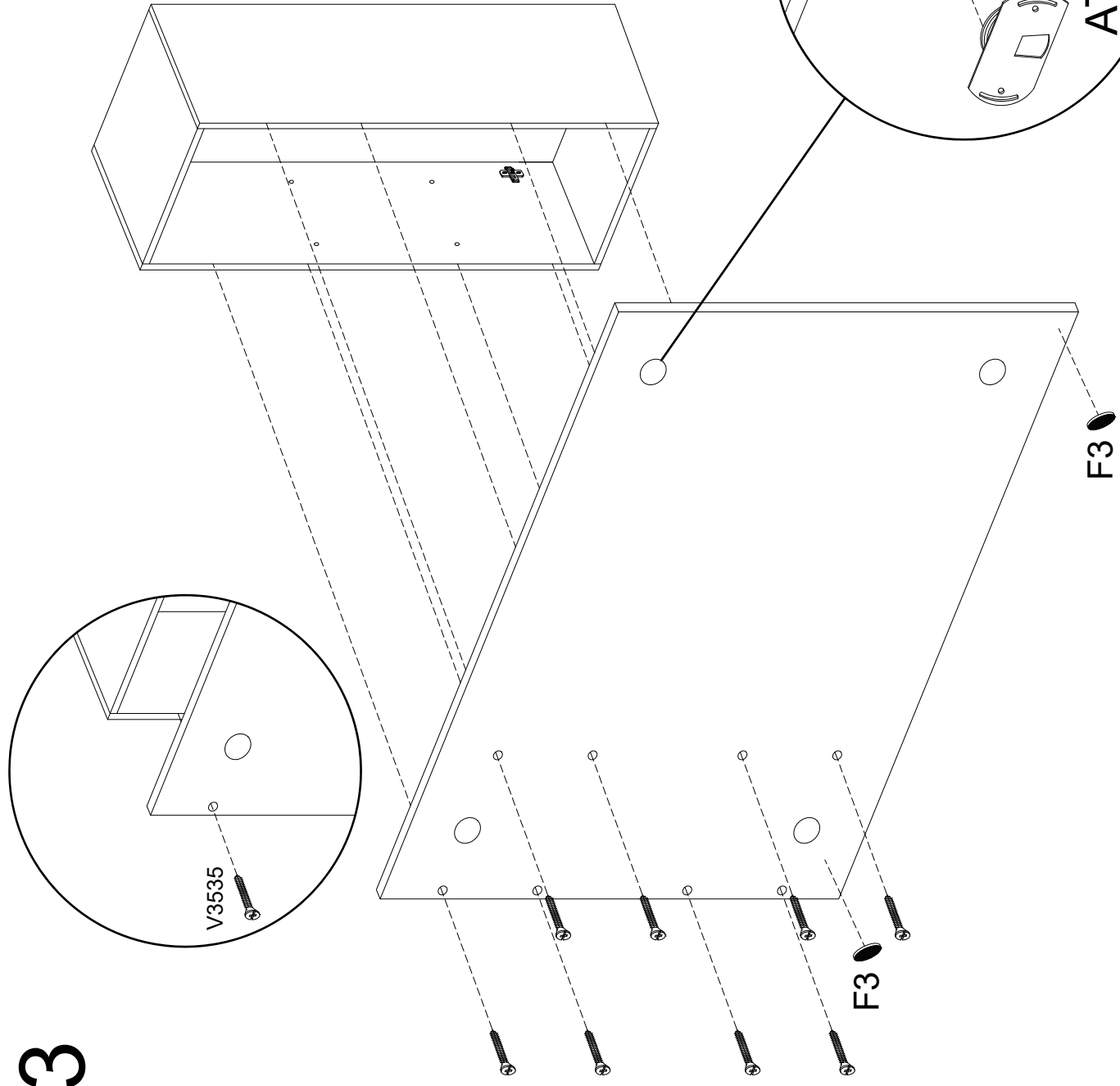

4

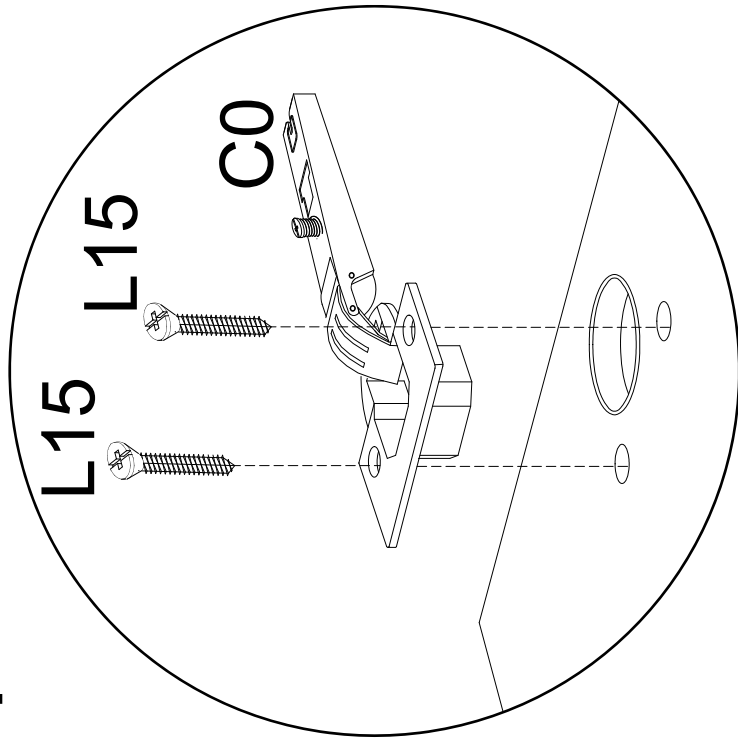

C0

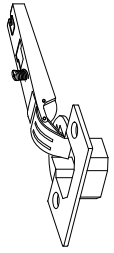

X2

L15



X4

4x15 mm.

P



X2

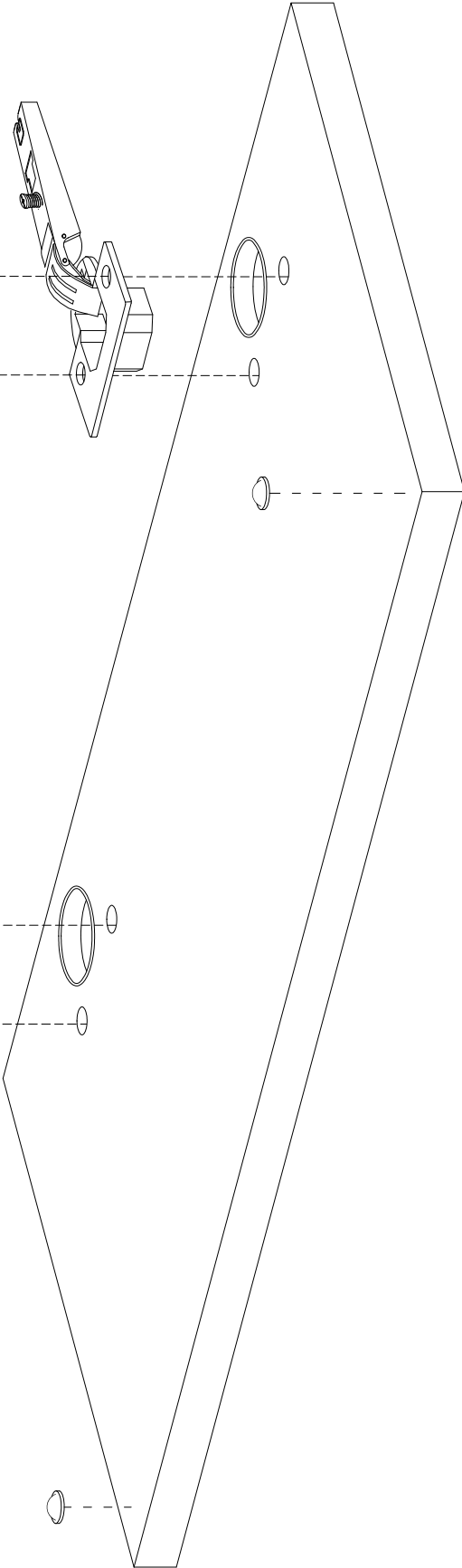
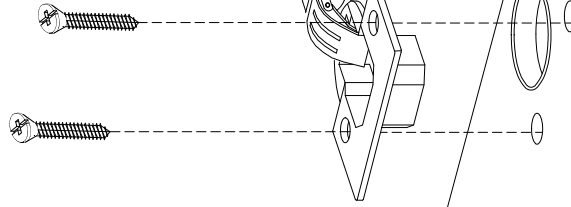
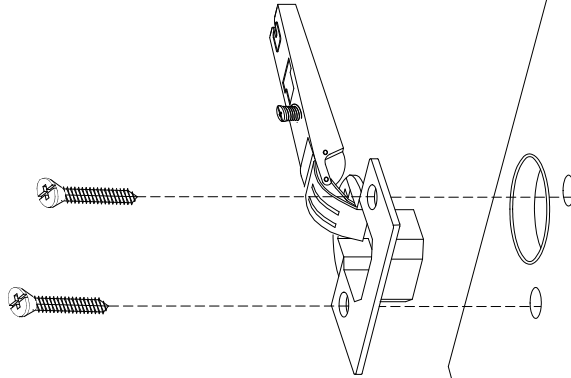

# 5

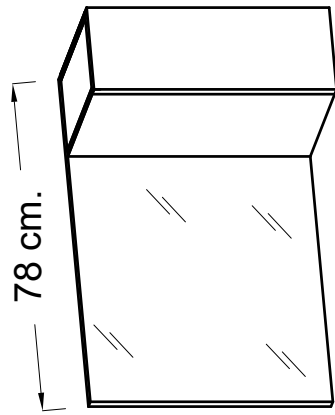
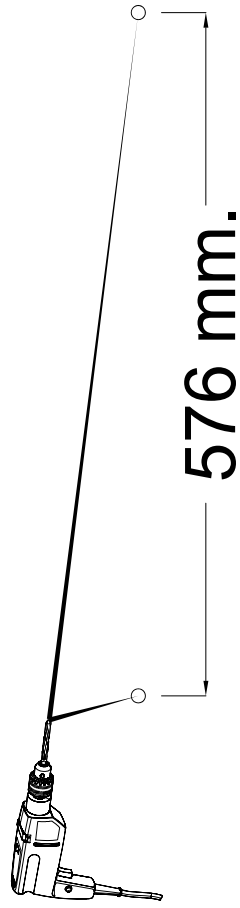

Cher client,

l'installation des meubles suspendus doit être effectuée par un personnel compétent.

Les fishers ne sont pas inclus dans la quincaillerie.

Choisir les types des fishers pour le fixage apte au mur.

S'assurer de l'adéquation du mur pour support sûr du meuble

Dear Customer

The assembling of the hanging elements must be done by a competent staff.

The fishers are not included in the hardware package.

Choose the fisher more suitable to the type of the wall.

Ensure the suitability of the wall for a secure support of the hanging element.

Sehr geehrter Kunde, die Montage der Haengeelemente muss von Fachpersonal ausgefuehrt werden!

Bitte verwenden Sie eigene, der Beschaffenheit der Wand entsprechende Duebel. Zu Ihrer eigenen

Sicherheit legen wir dem Beschlagbeutel keine Fischerduebel bei.

Gentile Cliente

Il montaggio dei pensili deve essere effettuato da personale competente.

I tasselli di fissaggio non sono compresi nella ferramenta.

Scegliere il tipo di tassello per il fissaggio più adatto alla tipologia di muro.

Assicurarsi l'idoneità della parete per un sostegno sicuro del pensile.

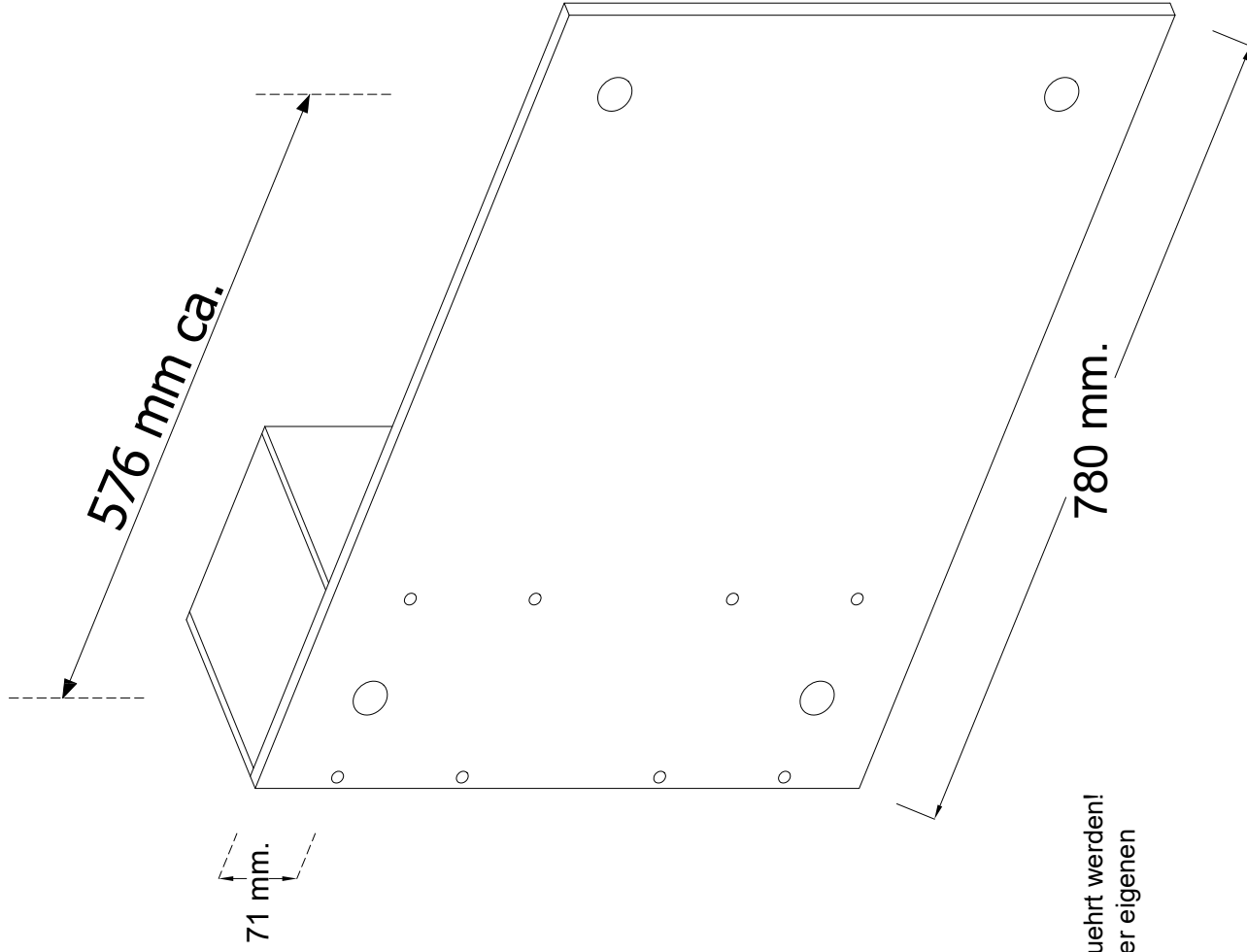

# 5

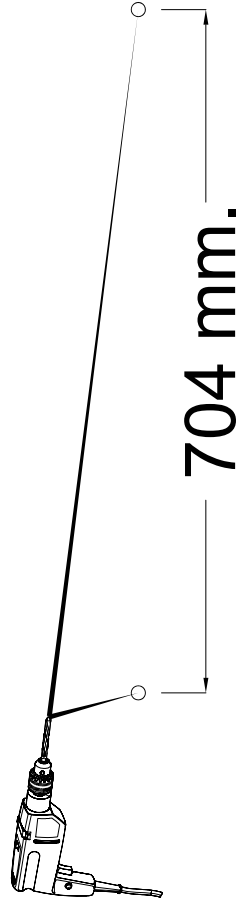

704 mm.

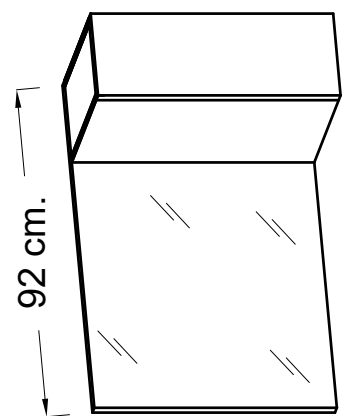

92 cm.

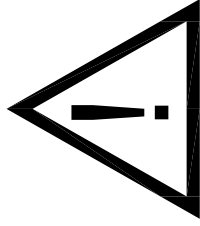

Cher client,  
l'installation des meubles suspendus doit être effectuée par un personnel compétent.  
Les fishers ne sont pas inclus dans la quincaillerie.  
Choisir les types des fishers pour le fixage apte au mur.  
S'assurer de l'adéquation du mur pour support sûr du meuble

Dear Customer  
The assembling of the hanging elements must be done by a competent staff.  
The fishers are not included in the hardware package.  
Choose the fisher more suitable to the type of the wall.  
Ensure the suitability of the wall for a secure support of the hanging element.

Sehr geehrter Kunde, die Montage der Haengeelemente muss von Fachpersonal ausgefuehrt werden!  
Bitte verwenden Sie eigene, der Beschaffenheit der Wand entsprechende Duebel. Zu Ihrer eigenen Sicherheit legen wir dem Beschlagbeutel keine Fischerduebel bei.

Gentile Cliente  
Il montaggio dei pensili deve essere effettuato da personale competente.  
I tasselli di fissaggio non sono compresi nella ferramenta.  
Scegliere il tipo di tassello per il fissaggio più adatto alla tipologia di muro.  
Assicurarsi l'idoneità della parete per un sostegno sicuro del pensile.

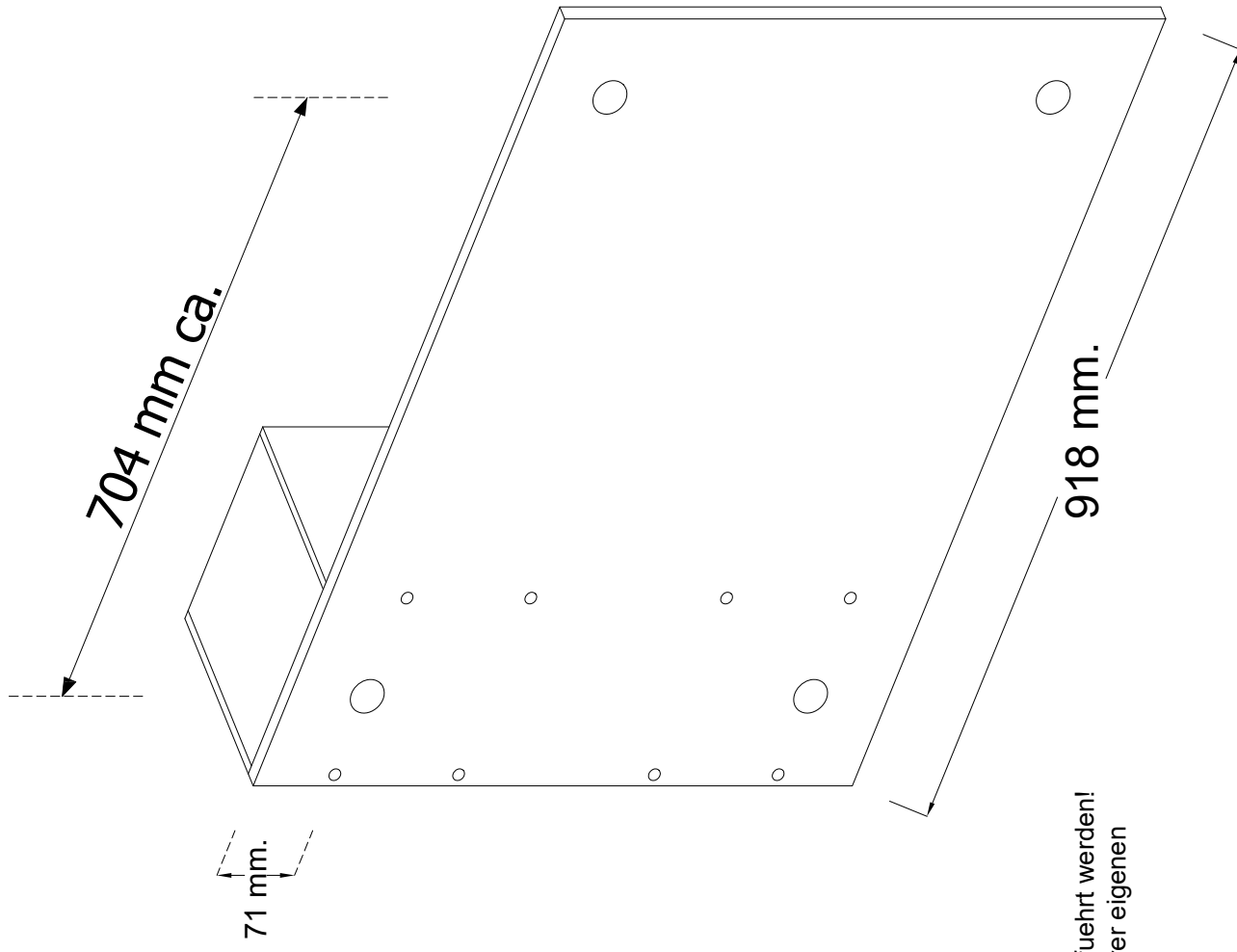

704 mm ca.

71 mm.

918 mm.

# 5

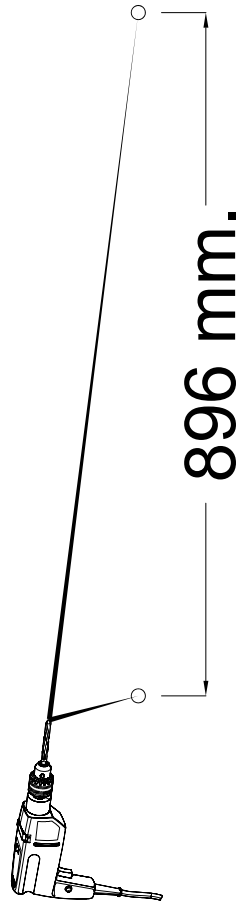

896 mm.

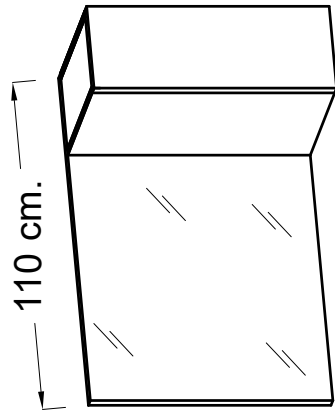

110 cm.

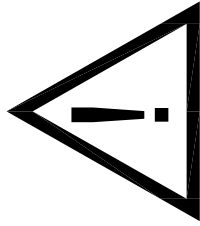

Cher client,

l'installation des meubles suspendus doit être effectuée par un personnel compétent.

Les fishers ne sont pas inclus dans la quincaillerie.

Choisir les types des fishers pour le fixage apte au mur.

S'assurer de l'adéquation du mur pour support sûr du meuble

Dear Customer

The assembling of the hanging elements must be done by a competent staff.

The fishers are not included in the hardware package.

Choose the fisher more suitable to the type of the wall.

Ensure the suitability of the wall for a secure support of the hanging element.

Sehr geehrter Kunde, die Montage der Haengeelemente muss von Fachpersonal ausgefuehrt werden!

Bitte verwenden Sie eigene, der Beschaffenheit der Wand entsprechende Duebel. Zu Ihrer eigenen

Sicherheit legen wir dem Beschlagbeutel keine Fischerduebel bei.

Gentile Cliente

Il montaggio dei pensili deve essere effettuato da personale competente.

I tasselli di fissaggio non sono compresi nella ferramenta.

Scegliere il tipo di tassello per il fissaggio più adatto alla tipologia di muro.

Assicurarsi l'idoneità della parete per un sostegno sicuro del pensile.

