

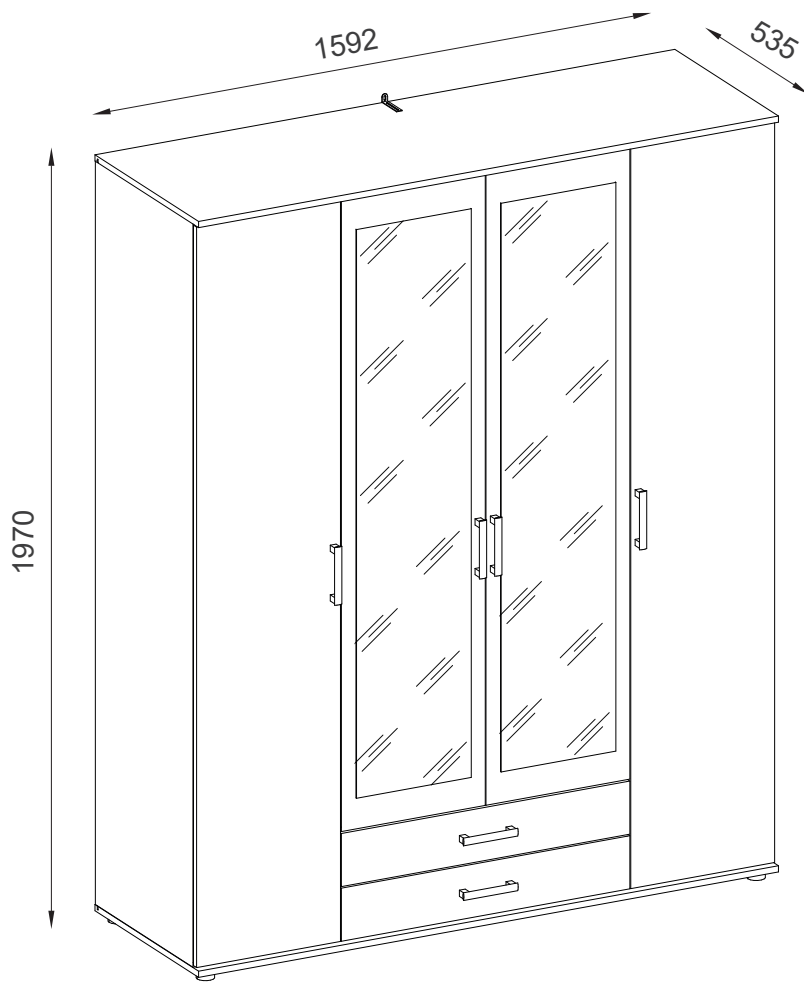

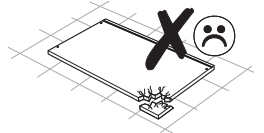

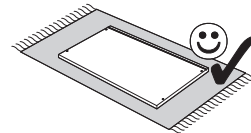

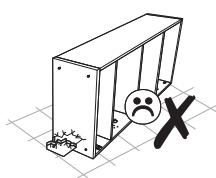

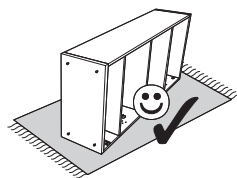
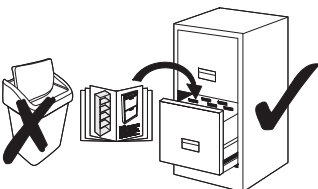
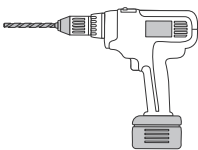
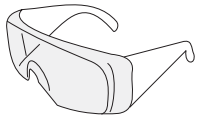
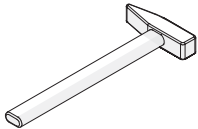
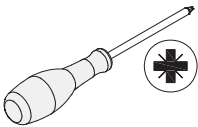
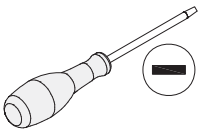
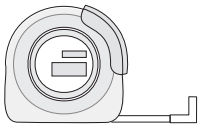
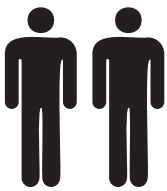
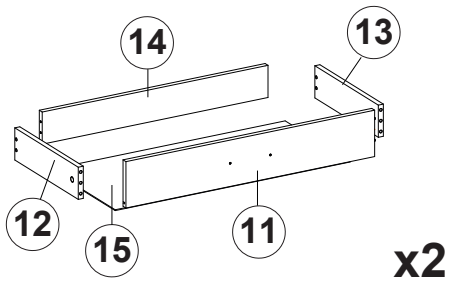
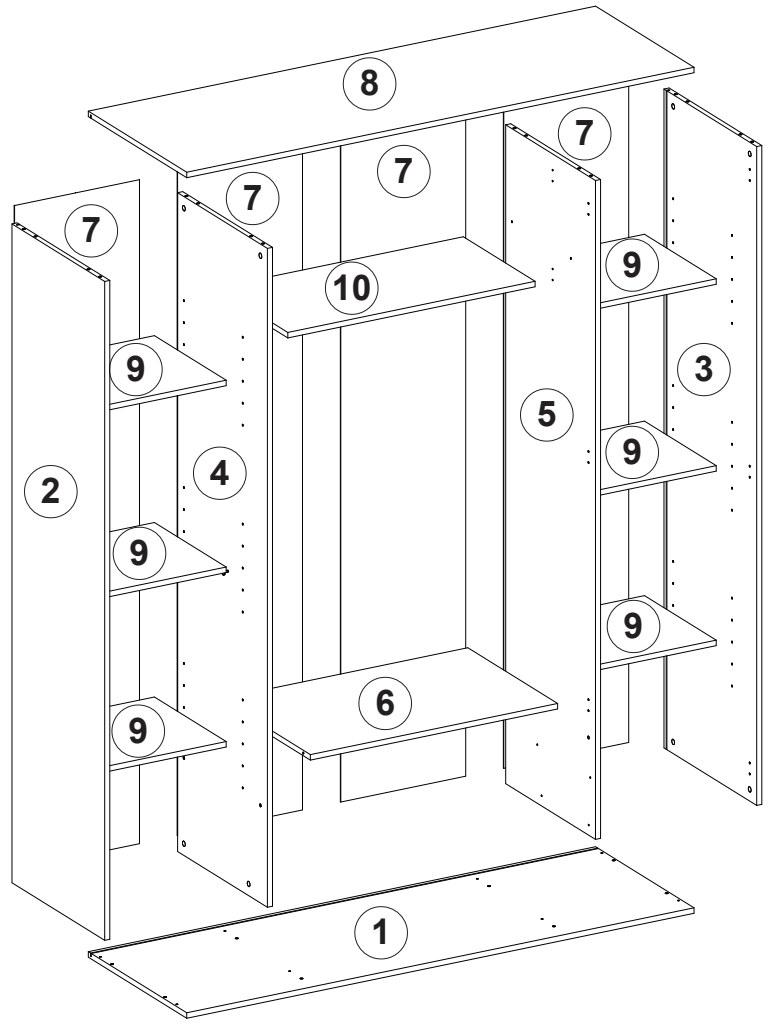
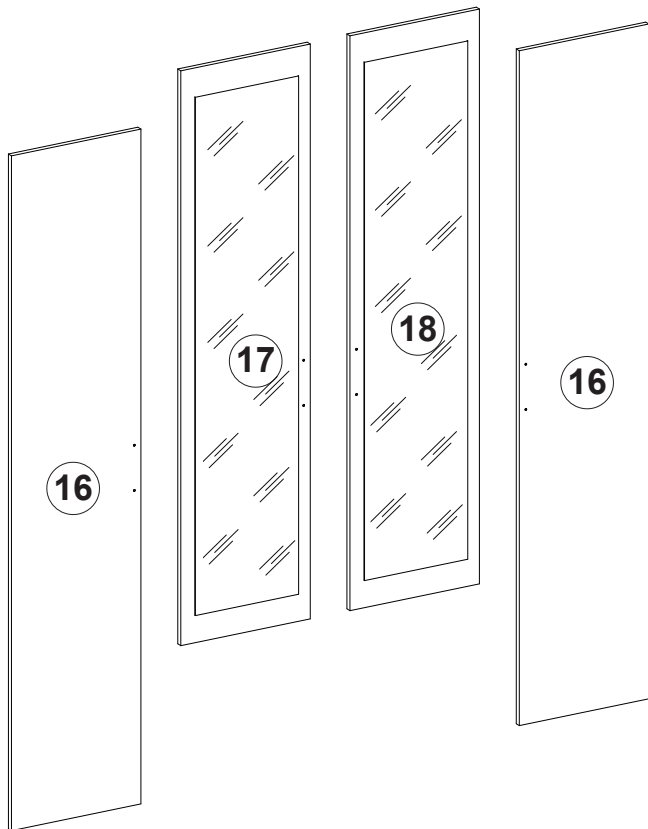



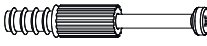

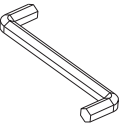
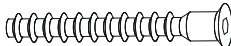
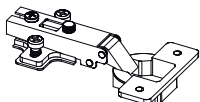
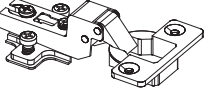



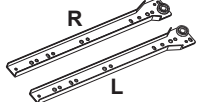
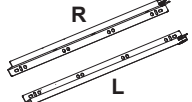

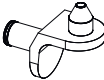
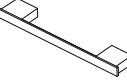

Modell **POSADA 4D**

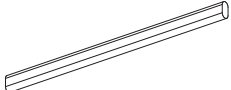
12.10.2023



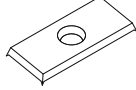
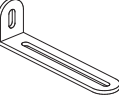





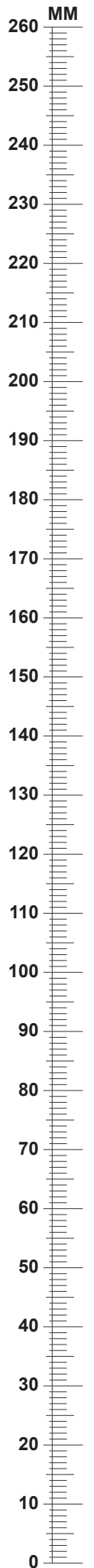

A	B (mm)		C	D
1	1592	535	16	x1 1/3
2	1918	504	16	x1 2/3
3	1918	504	16	x1 2/3
4	1918	488	16	x1 2/3
5	1918	488	16	x1 2/3
6	776	488	16	x1 1/3
7	1933	392	2,5	x4 1/3
8	1592	535	16	x1 3/3
9	375	390	16	x6 1/3
10	776	390	16	x1 1/3
11	792	137	16	x2 1/3
12	350	95	16	x2 1/3
13	350	95	16	x2 1/3
14	719	95	16	x2 1/3
15	748	358	2,5	x2 1/3
16	1910	395	16	x2 3/3
17	1627	395	16	x1 3/3
18	1627	395	16	x1 3/3

<p>20x</p>  <p>45mm r23</p>	<p>20x</p>  <p>Ø 15x12mm r1</p>	<p>24x</p>  <p>Ø 8x30mm f1</p>
<p>1x</p>  <p>4mm z1</p>	<p>12x</p>  <p>Ø 6,3x50mm e27</p>	<p>6x</p>  <p>Ø 35mm ab1</p>
<p>6x</p>  <p>Ø 35mm ab2</p>	<p>32x</p>  <p>Ø 3,5x16mm p51</p>	<p>6x</p>  <p>45x45x20mm k54</p>
<p>6x</p>  <p>Ø 4x25mm p23</p>	<p>2x</p>  <p>L=350mm n1/1</p>	<p>2x</p>  <p>L=350mm n1/2</p>
<p>8x</p>  <p>Ø 6x13mm e1</p>	<p>2x</p>  <p>Ø 5mm d1</p>	<p>28x</p>  <p>22x19x11mm d3</p>
<p>6x</p>  <p>L=128mm c252</p>	<p>12x</p>  <p>Ø 4,2x25mm p25</p>	<p>28x</p>  <p>10x10x15mm l2</p>
<p>2x</p>  <p>30x15mm t3</p>	<p>1x</p>  <p>L=770x23x15mm t1</p>	<p>28x</p>  <p>Ø 2x20mm g1</p>
<p>20x</p>  <p>Ø 20mm s2</p>	<p>4x</p>  <p>Ø 12mm s4</p>	<p>14x</p>  <p>L=20x10x2 mm n108</p>
<p>1x</p>  <p>L=75x25x15mm n14/2</p>	<p>16x</p>  <p>Ø 3x16mm p50</p>	<p>1x</p>  <p>L=1918mm t8</p>
	<p>4x</p>  <p>Ø 5x11 mm e5</p>	



1	f1 x 4  Ø 8x30mm	r1 x 4  Ø 15x12mm	b2 x 3  40x50x12mm	t3 x 1  30x15mm	e1 x 4  Ø 6x13mm	e5 x 2  Ø 5x11mm	n1/1 x 2  R L=350mm
----------	--	---	--	---	---	--	--

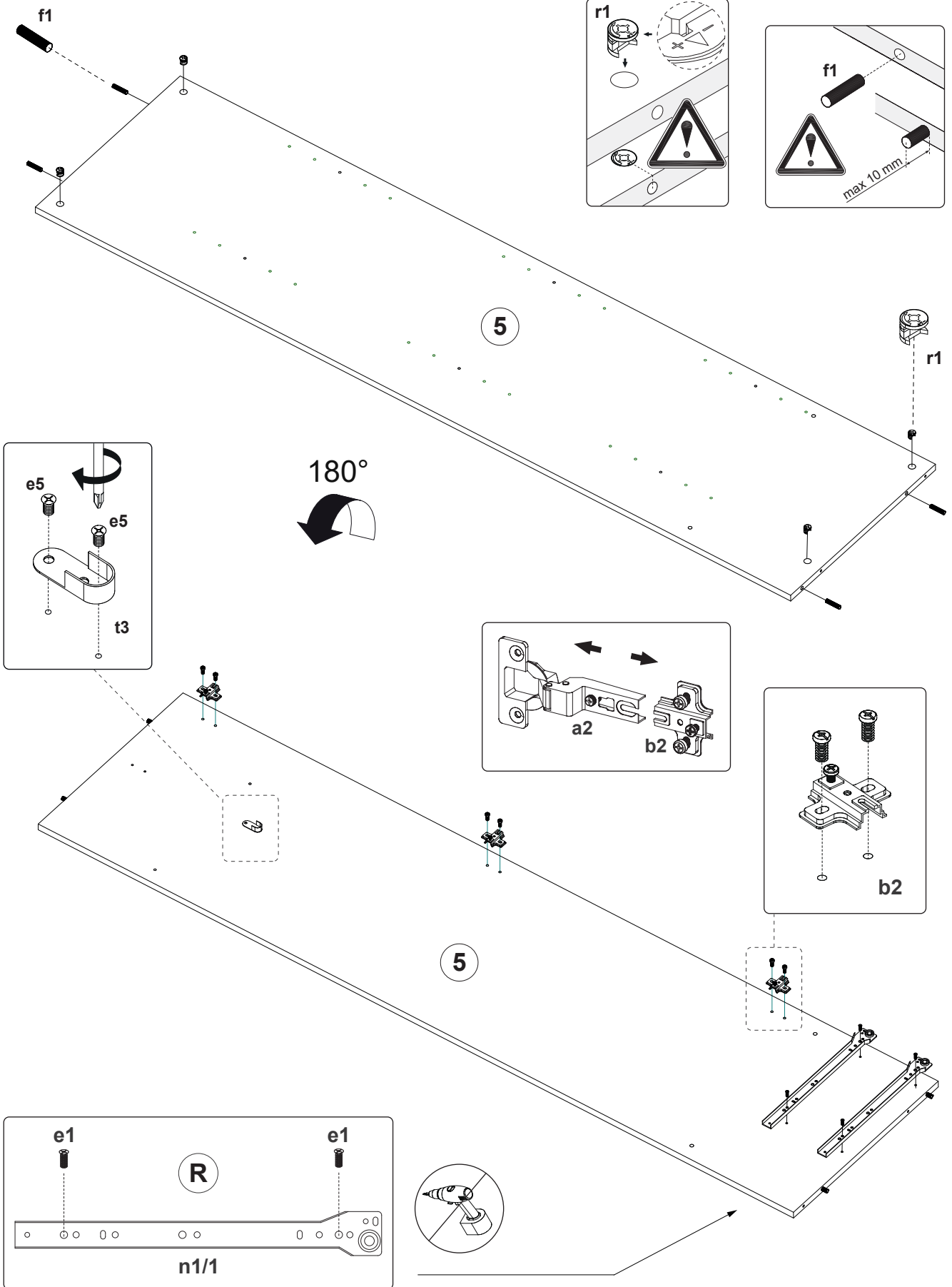

2

f1 x 4



Ø 8x30mm

r1 x 4



Ø 15x12mm

b2 x 3



40x50x12mm

t3 x 1



30x15mm

e1 x 4



Ø 6x13mm

e5 x 2



Ø 5x11mm

n1/1 x 2

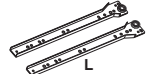

L=350mm

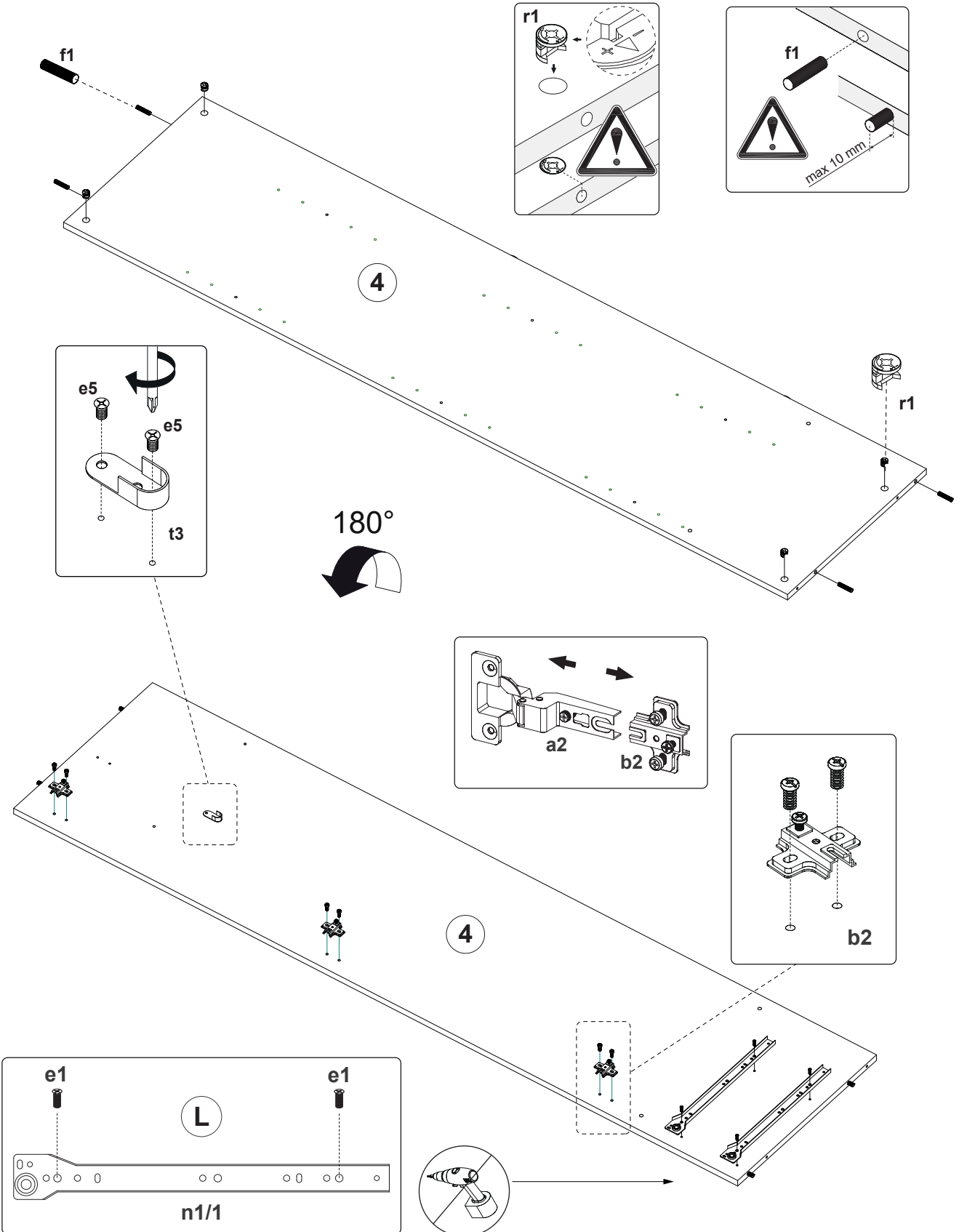

3

f1 x 8



Ø 8x30mm

r1 x 8



Ø 15x12mm

b1 x 6



40x50x12mm

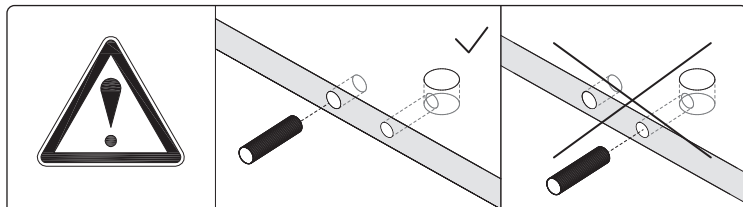
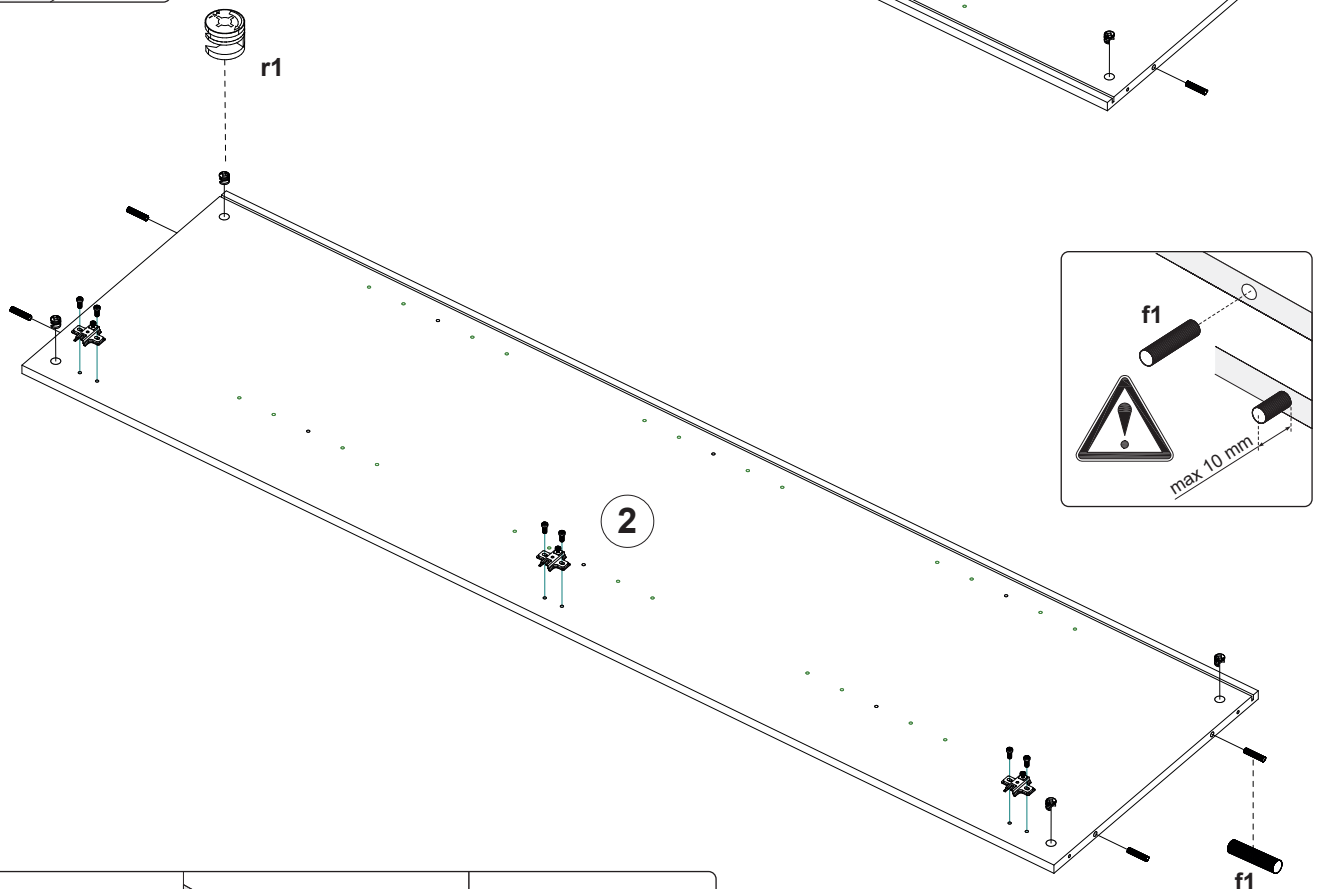
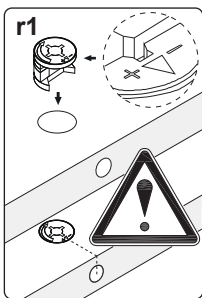
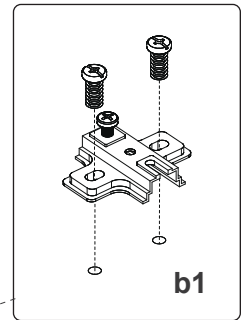
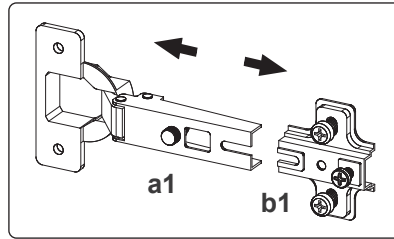

4

r23 x 16



45mm

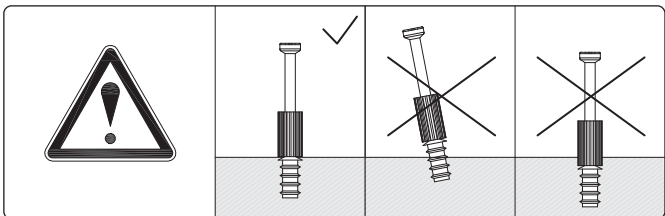
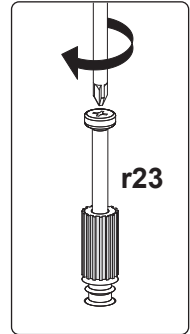
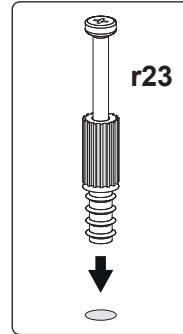
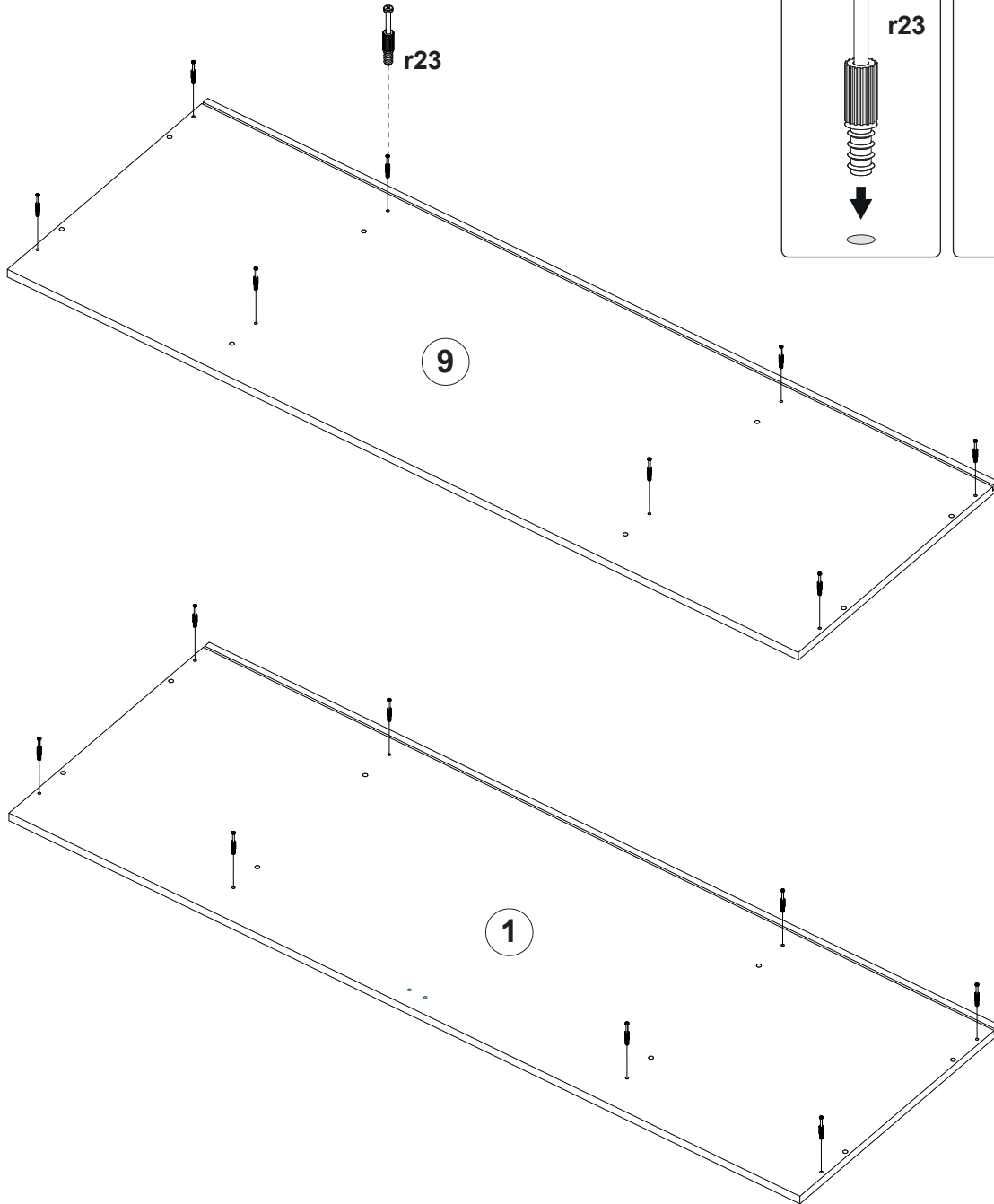

5

z1 x 1
4mm

e27 x 4
Ø 6,3x50mm

s4 x 4
Ø 14mm

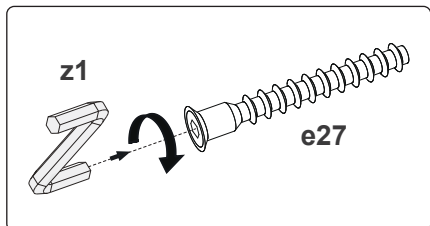
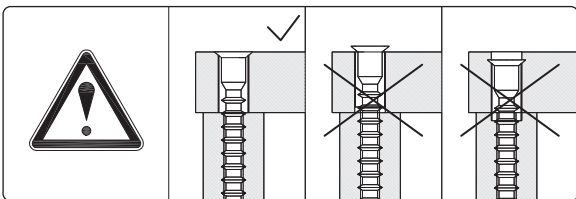
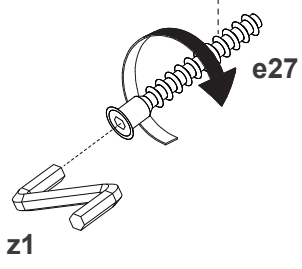
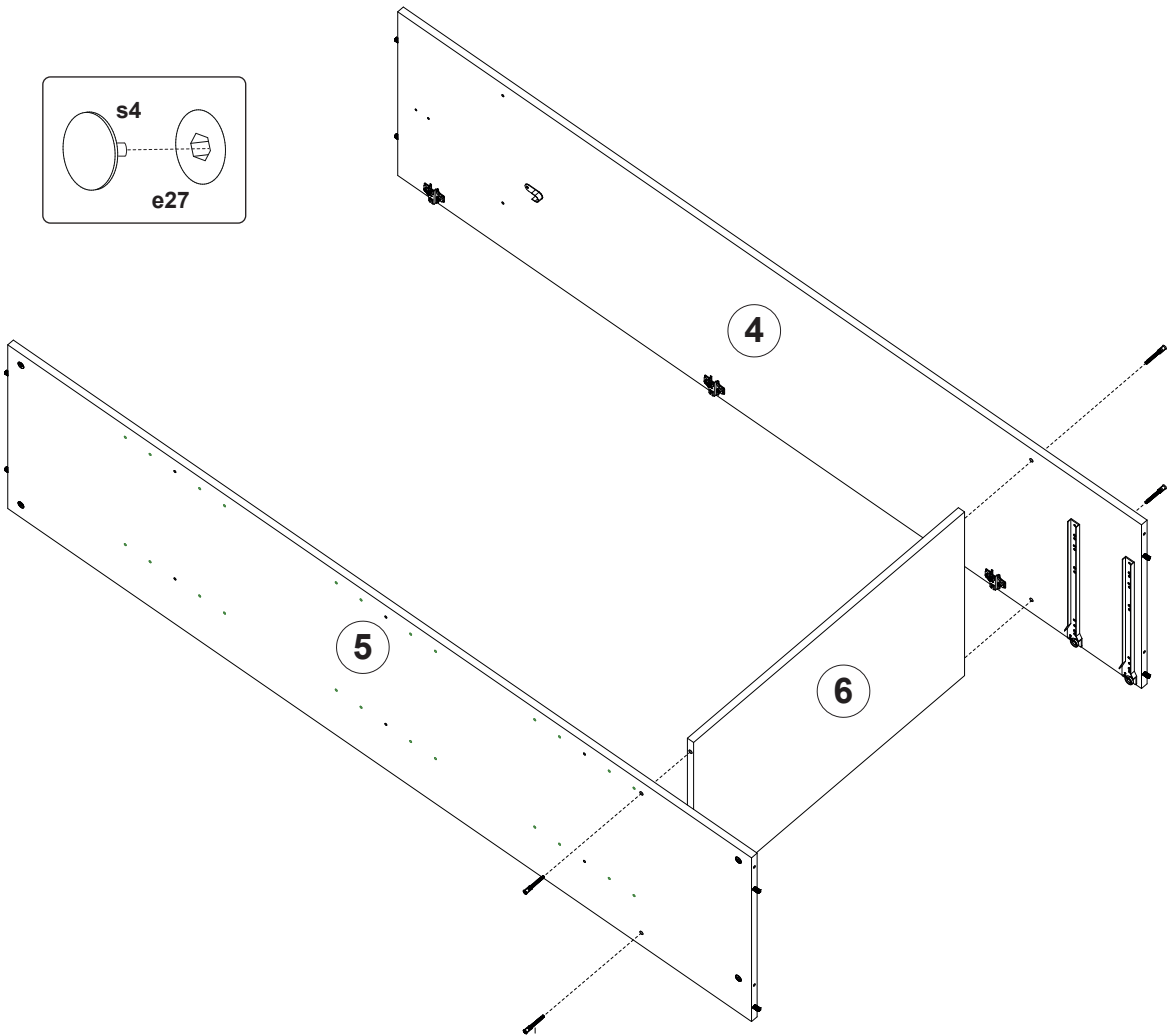
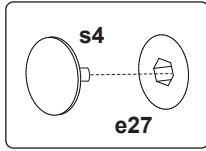

6

s2 x 8



Ø 20mm

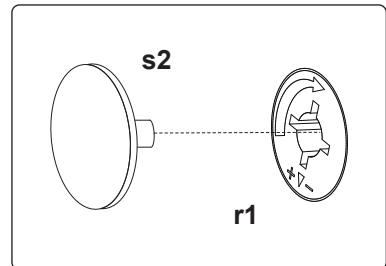
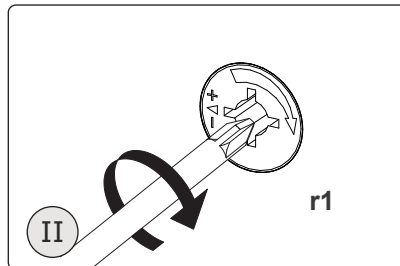
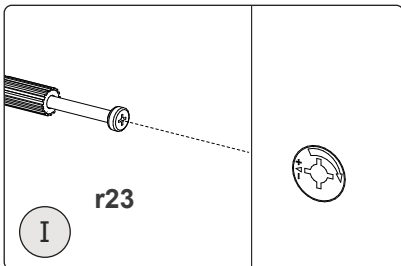
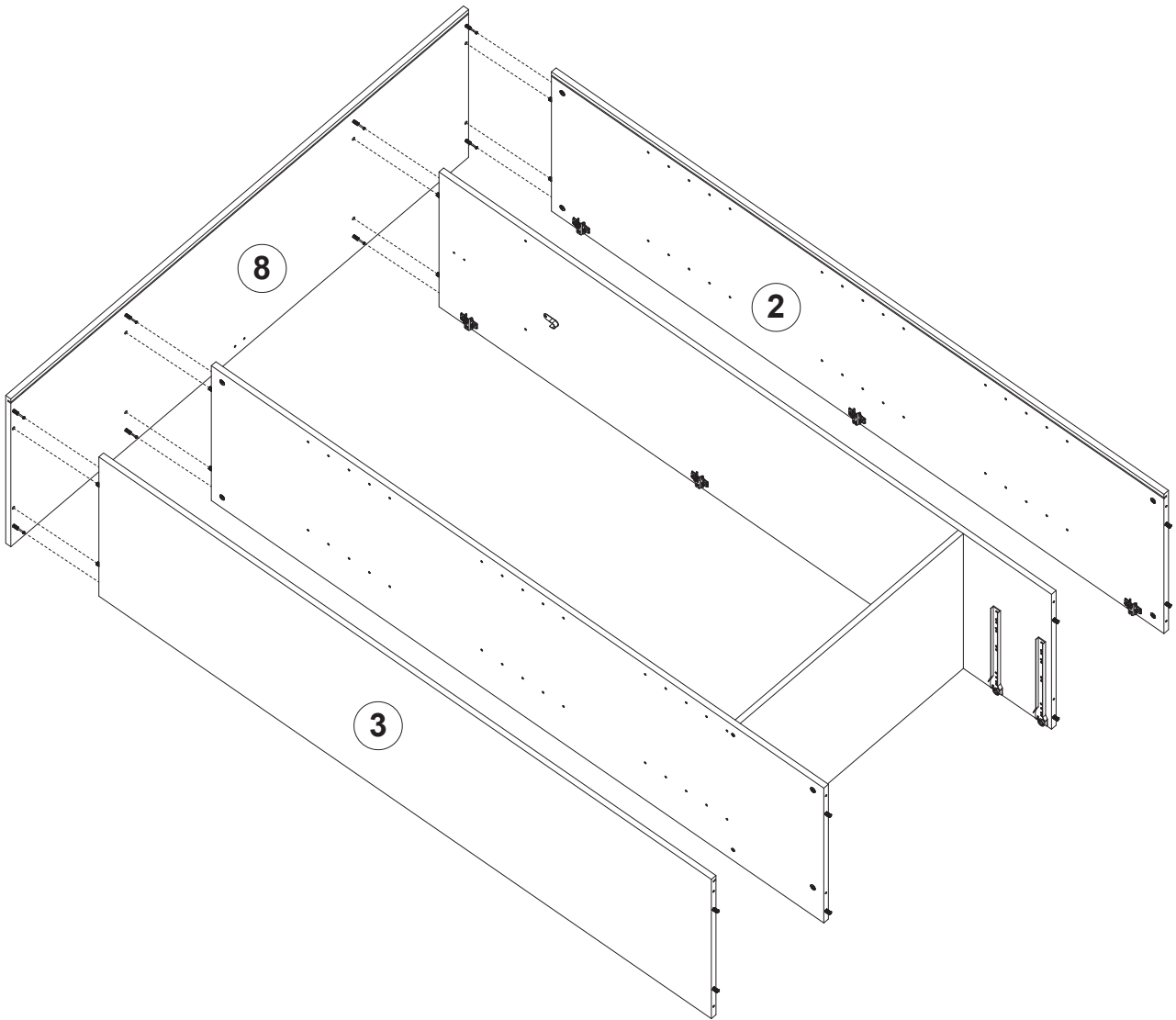

7	t8 x 1 L=1918mm
----------	--------------------

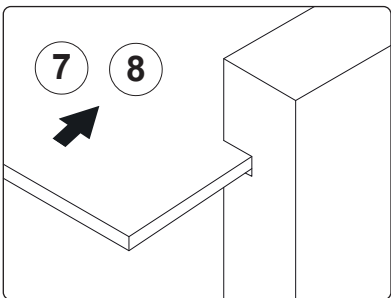
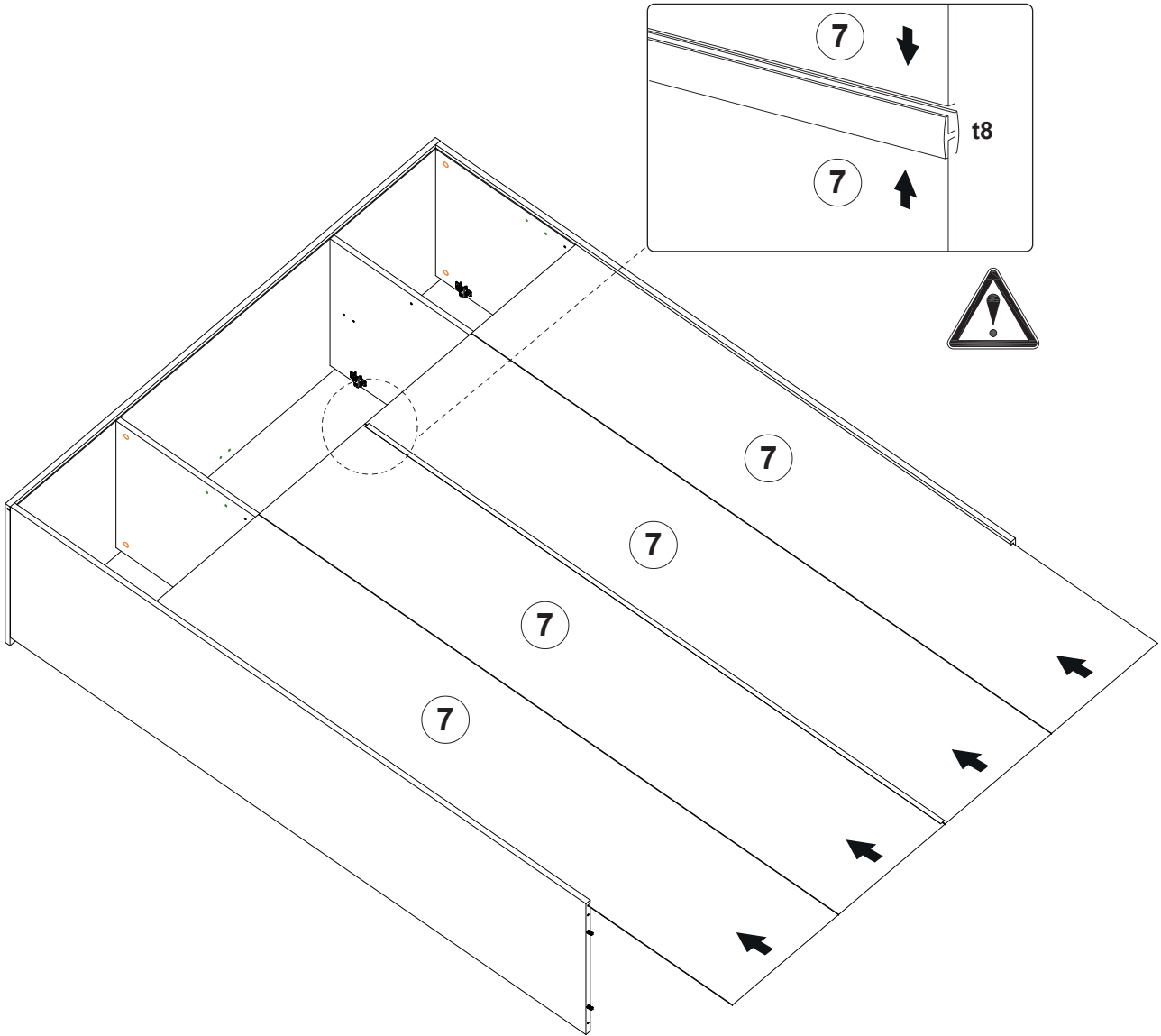

8

s2 x 8



Ø 20mm

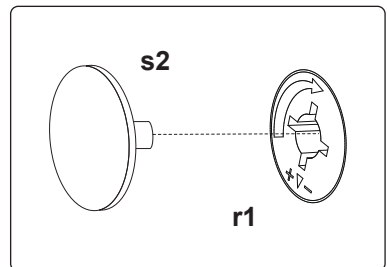
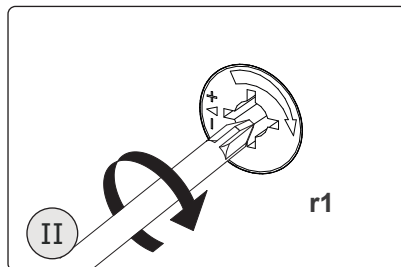
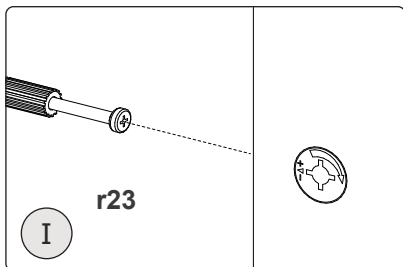
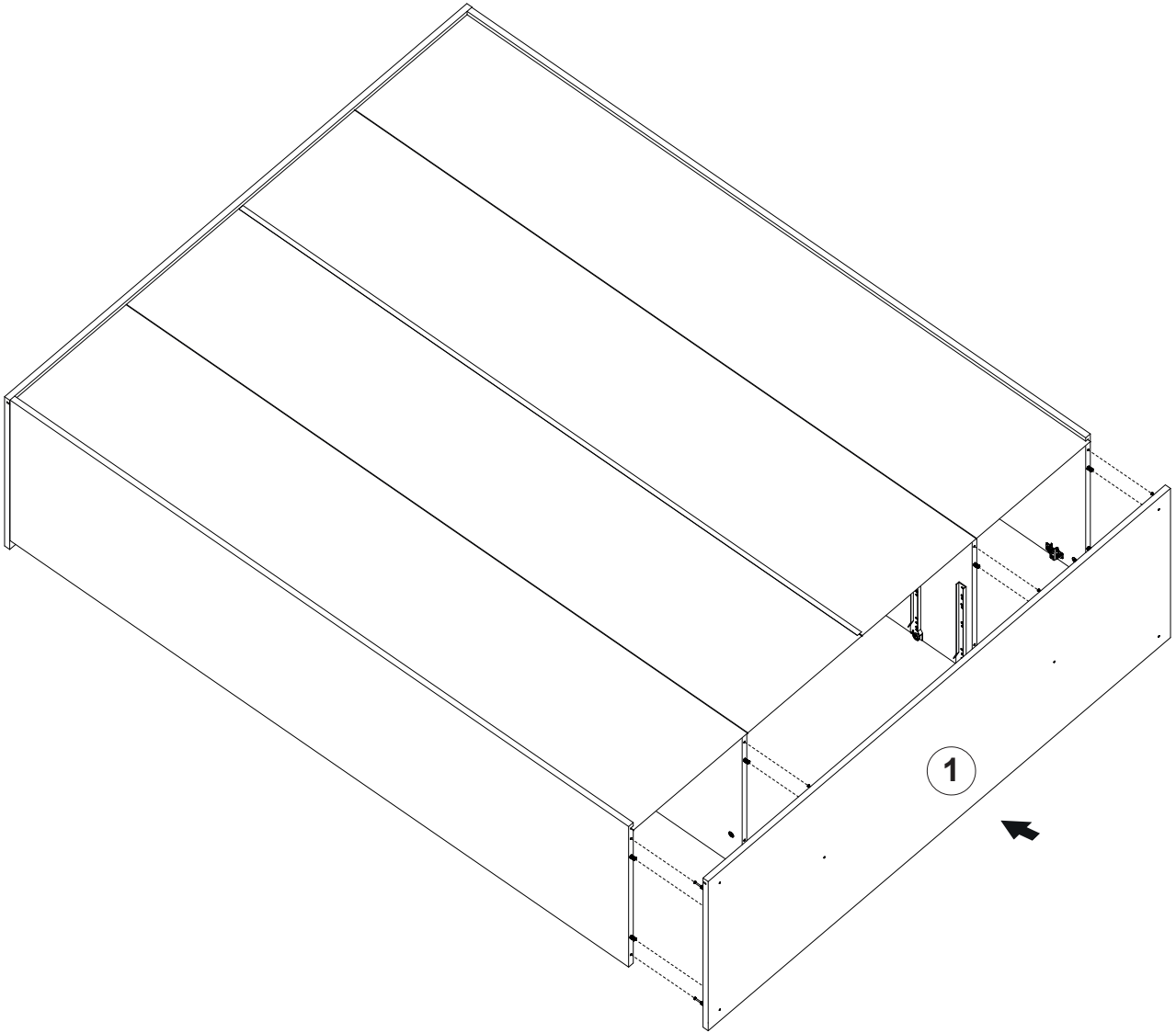

9

l2 x 24



10x10x15mm

n108 x 14

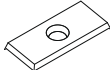

L=20x10x2mm

k54 x 6



45x45x20mm

p23 x 6



Ø 4x25mm

p50 x 14



Ø 3x16mm

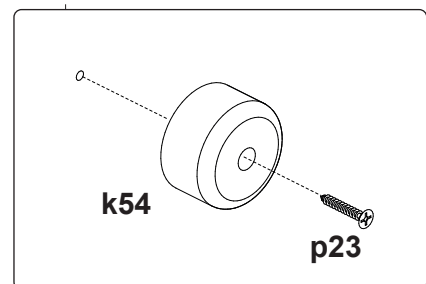
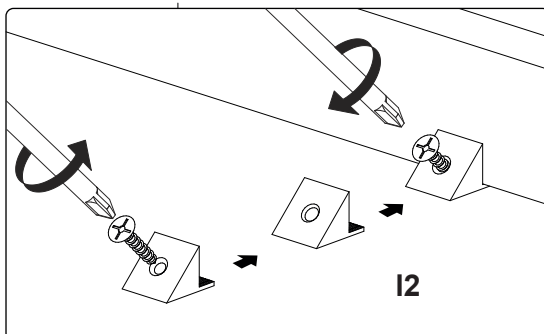
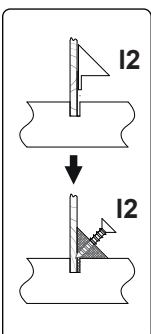
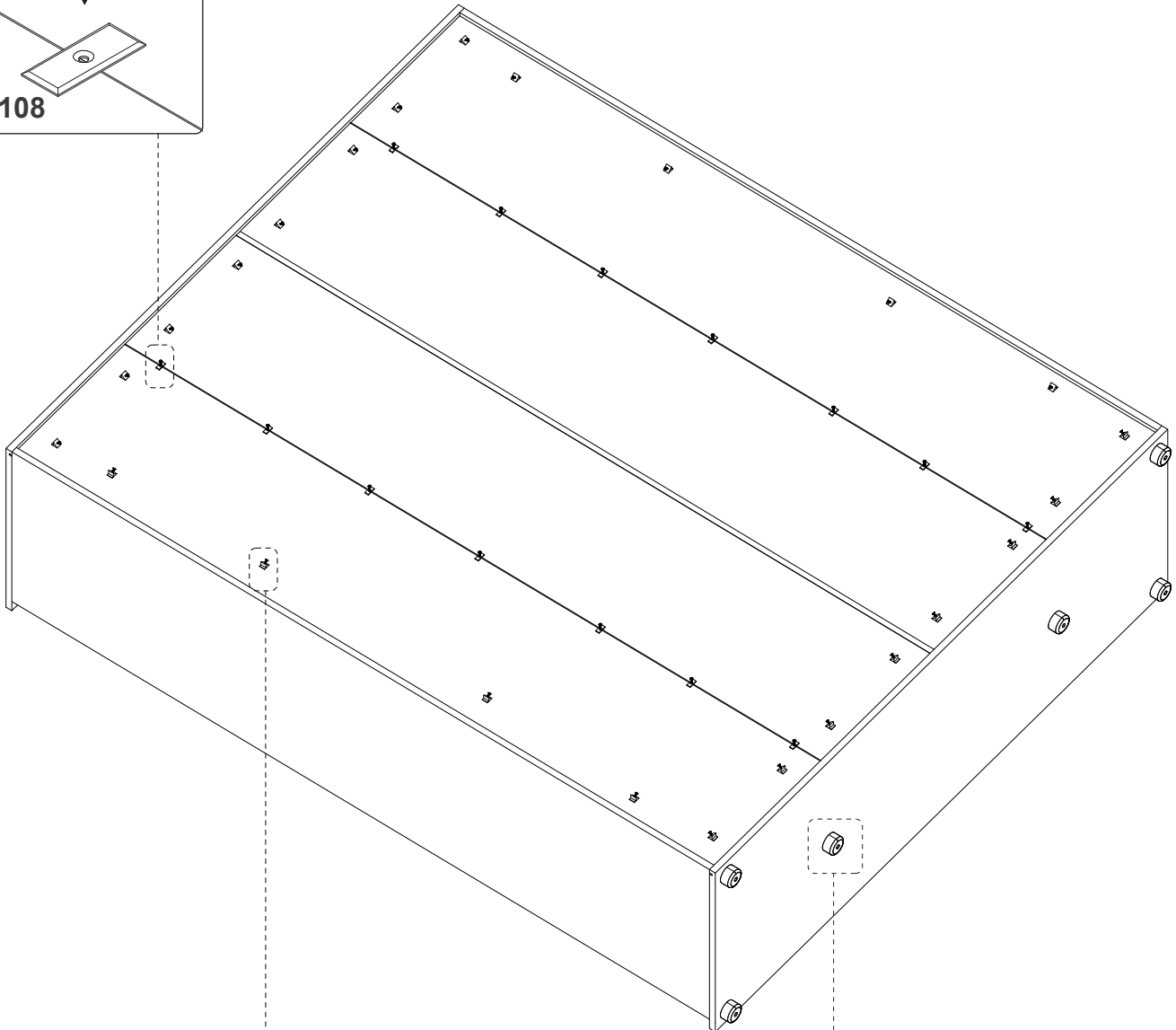
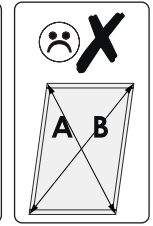
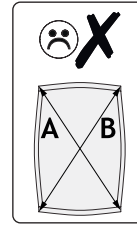
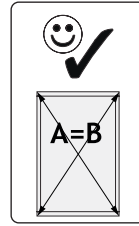
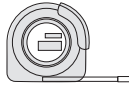
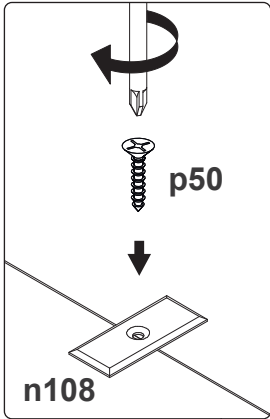

10

p50 x 2



Ø 3x16mm

n14/2 x 1

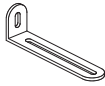

L=75x25x15mm

d3 x 28



22x19x11mm

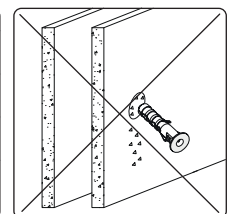
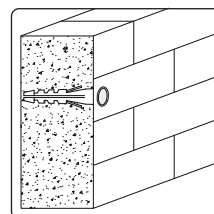
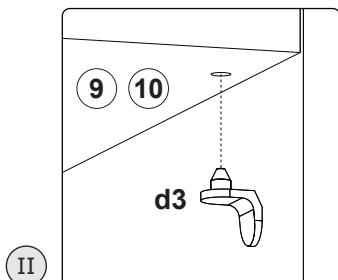
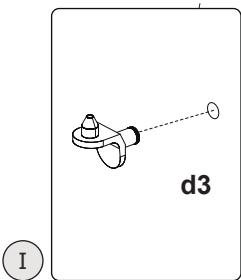
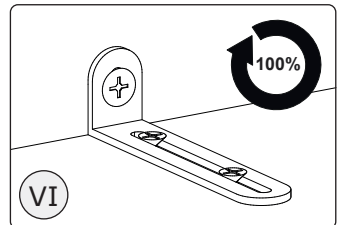
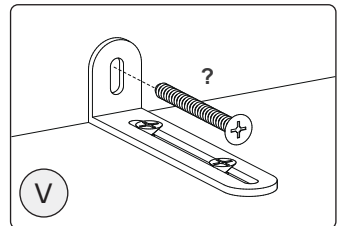
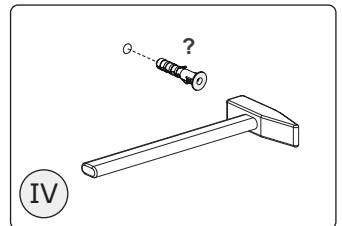
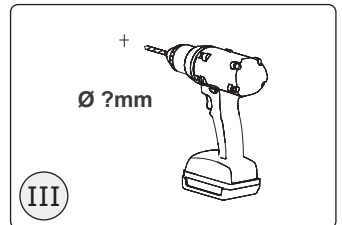
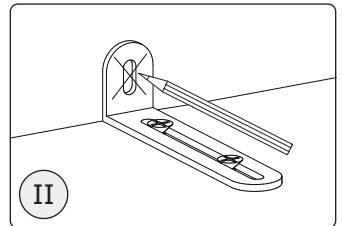
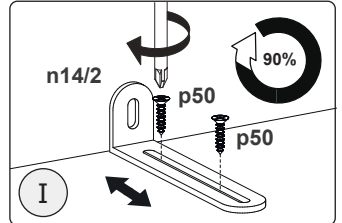
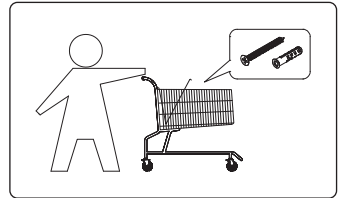
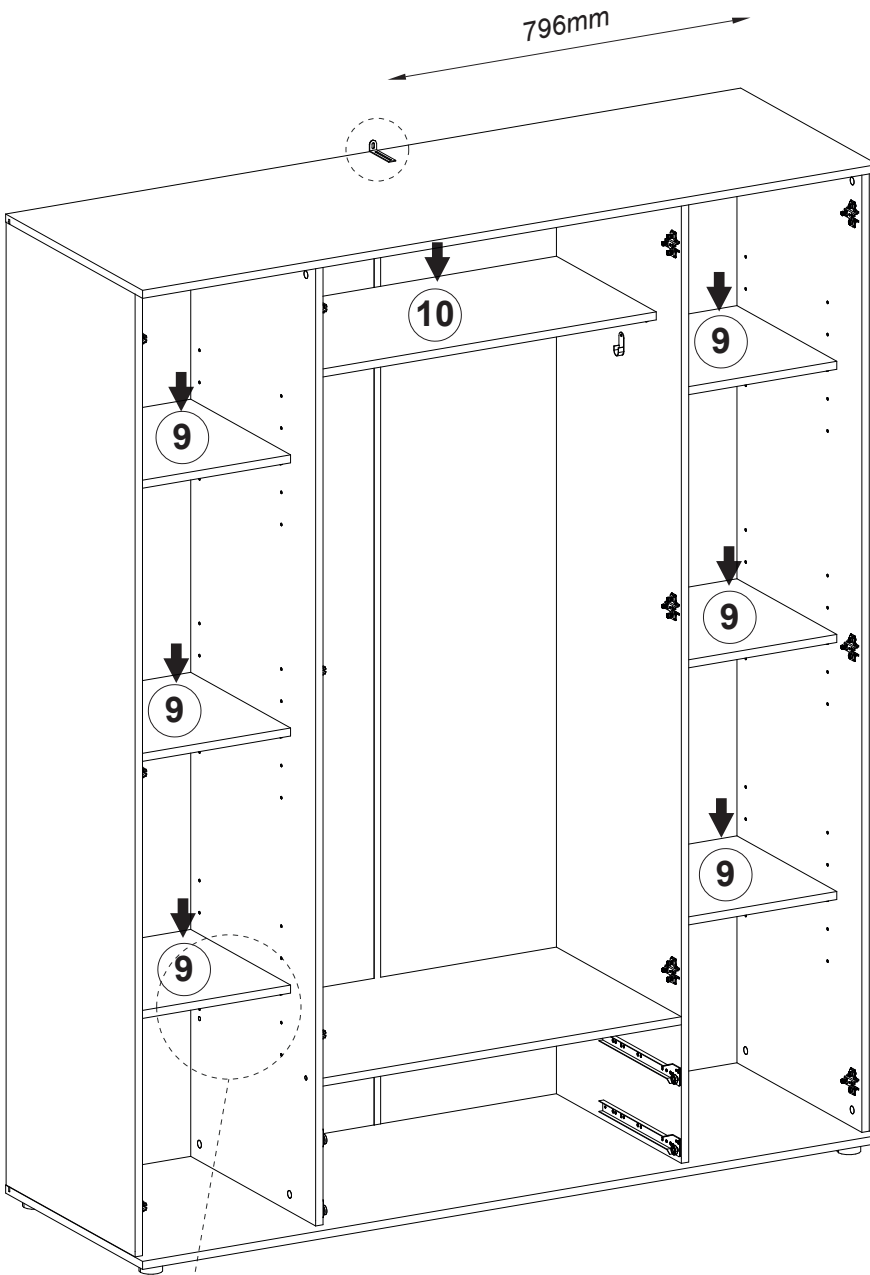

11	f1 x 8	r1 x 4	r23 x 4	z1 x 1	e27 x 8	c252 x 2	p25 x 4	s2 x 4
	Ø 8x30mm	Ø 15x12mm	45mm	4mm	Ø 6,3x50mm	L=128mm	Ø 4,2x25mm	Ø 20mm

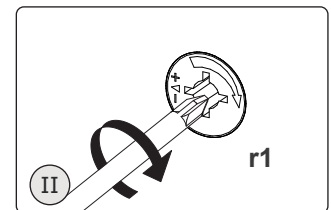
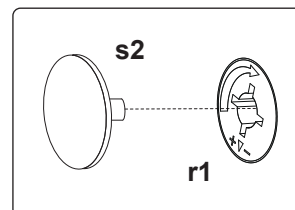
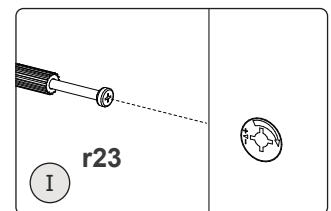
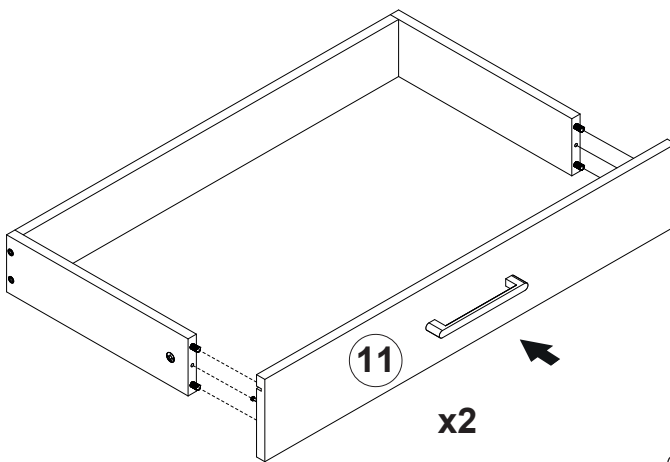
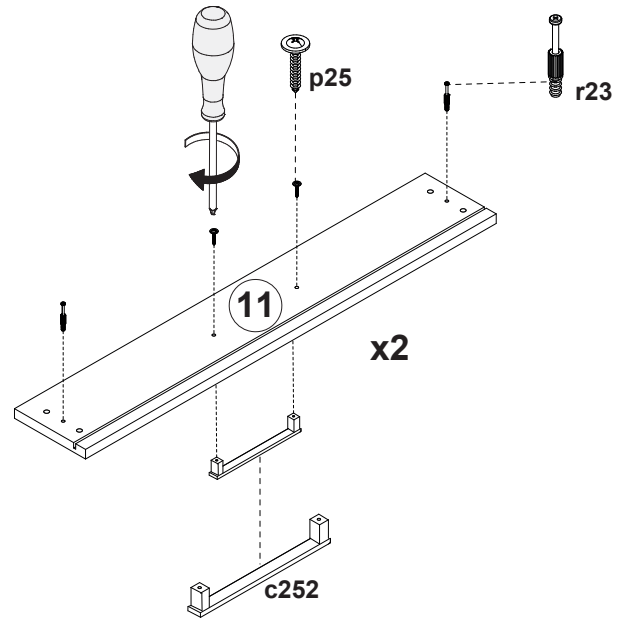
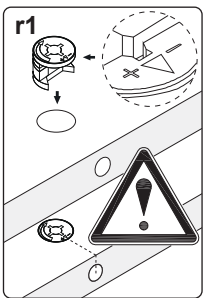
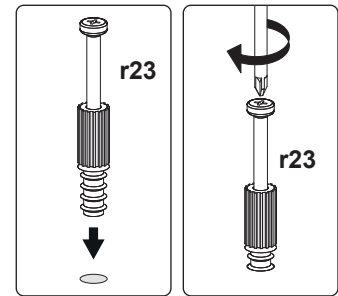
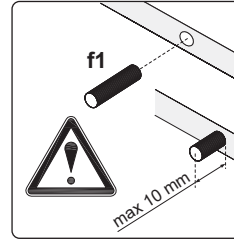
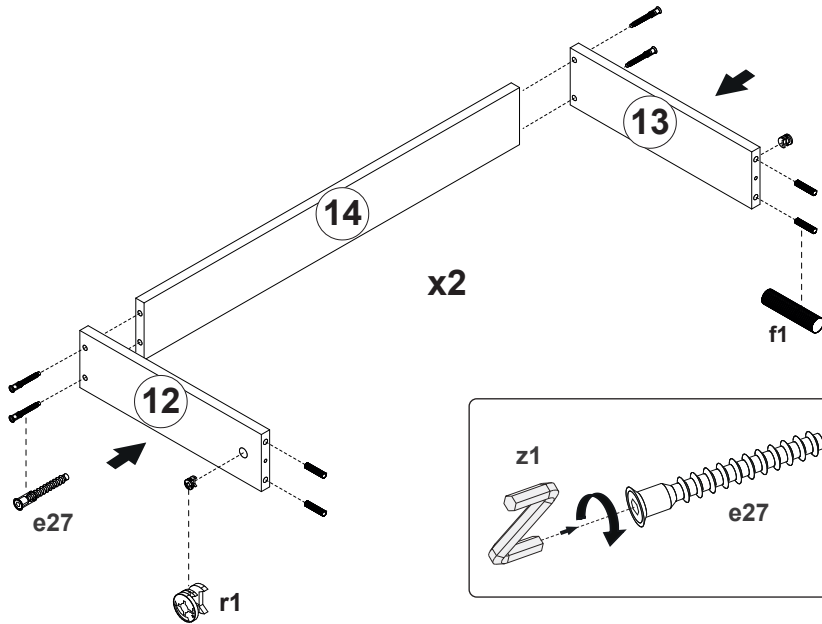

12

g1 x 30



Ø 2x20mm

n1/2 x 2

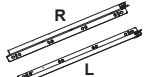

L=350mm

p51 x 8



Ø 3,5x16mm

I2 x 4



10x10x15mm

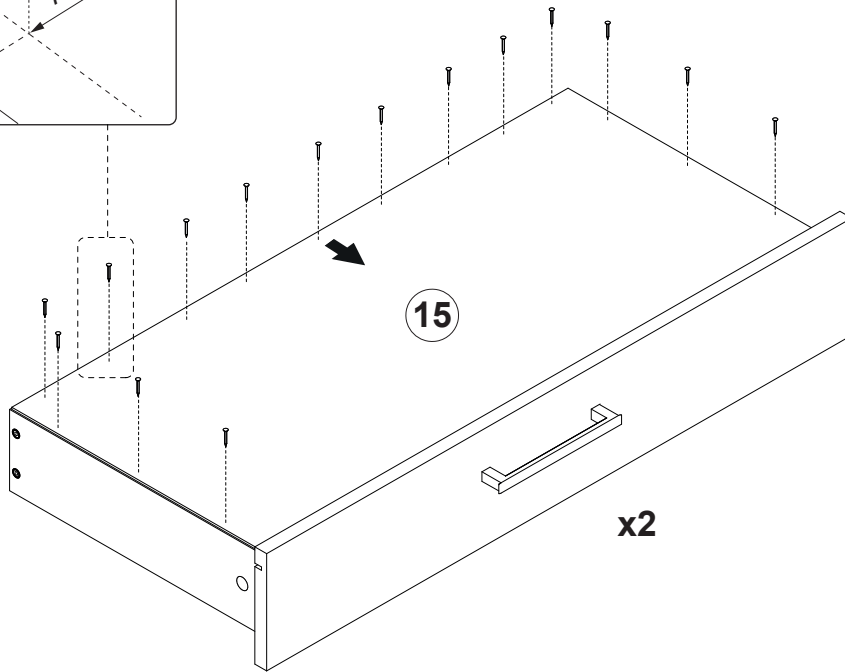
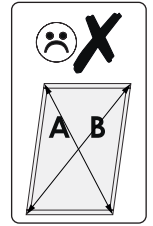
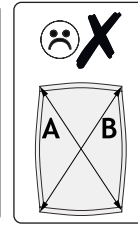
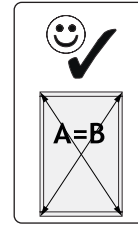
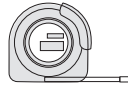
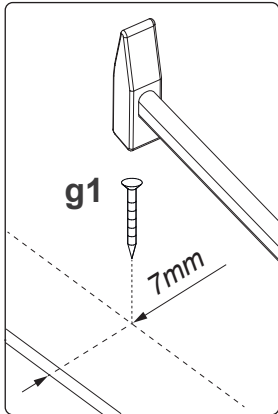

15

x2

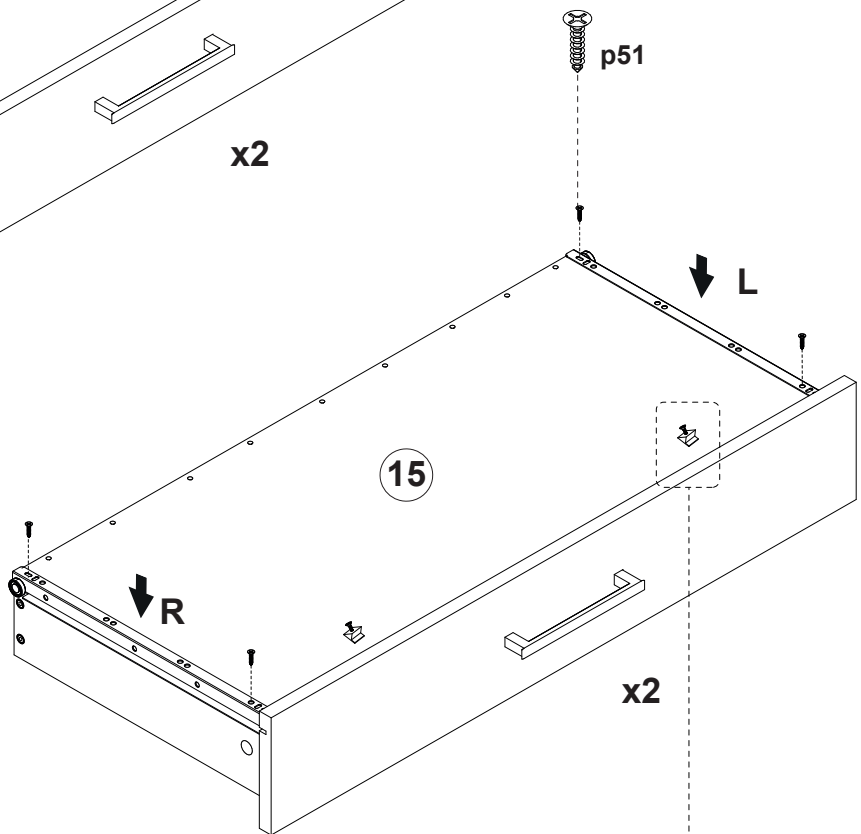

p51

L

15

x2

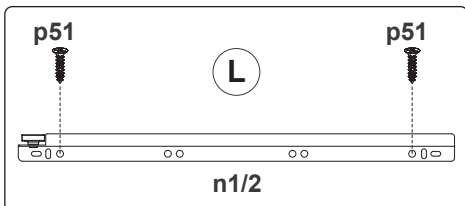

p51

L

p51

n1/2

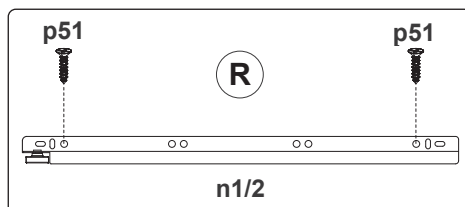

p51

R

p51

n1/2

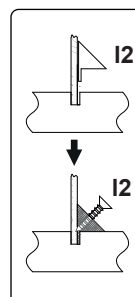

I2

I2

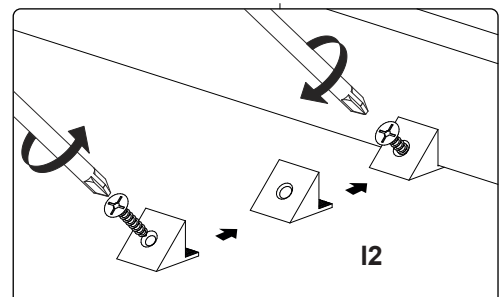

I2

13



t1 x 1

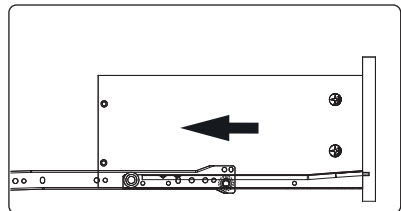
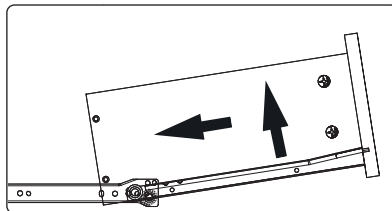
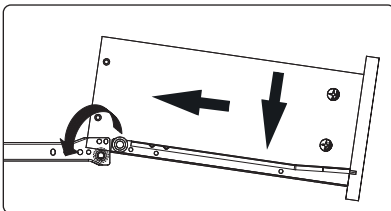
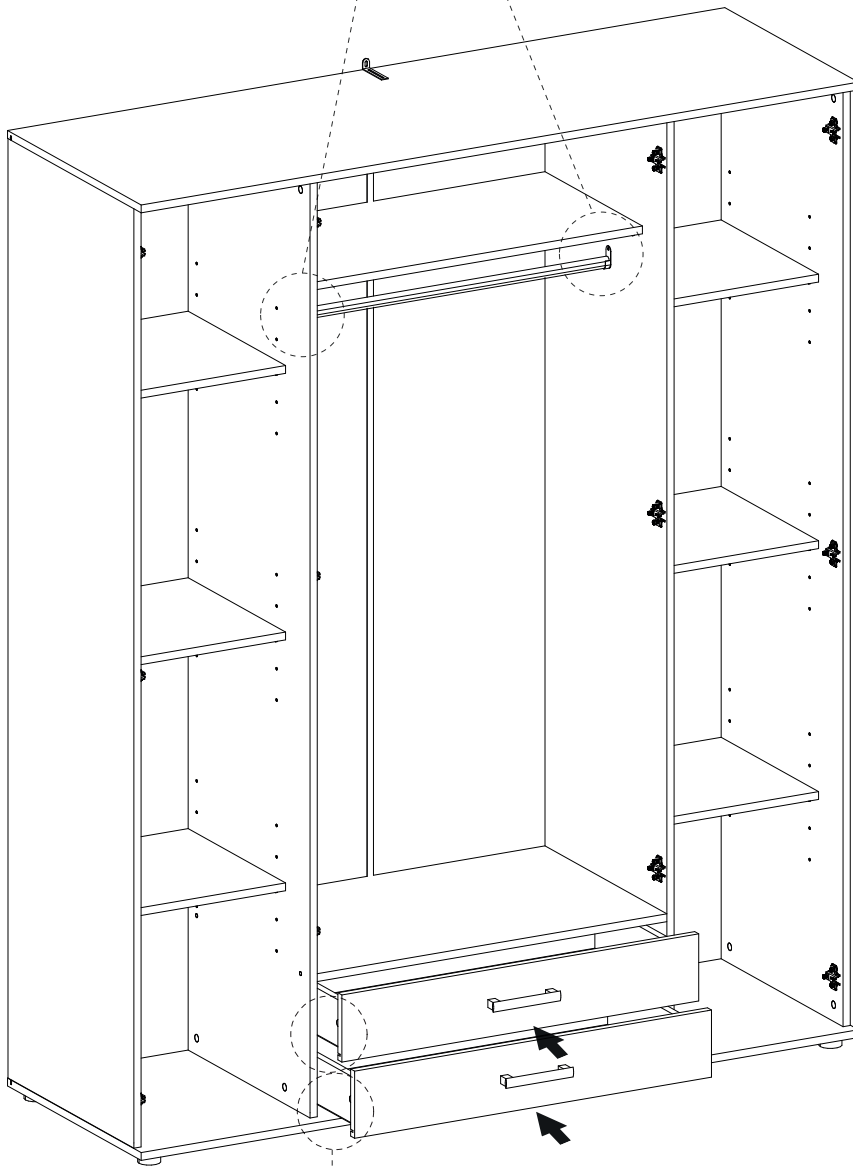
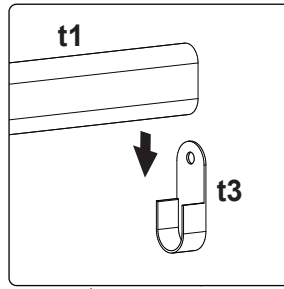

L=770x23x15mm

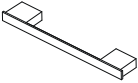

14

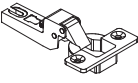
c252 x 2  L=128mm	p25 x 4  Ø 4,2x25mm	p51 x 12  Ø 3,5x16mm	a2 x 6  Ø 35mm
--	--	---	---

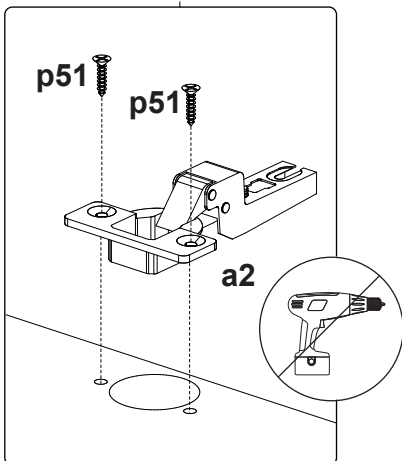
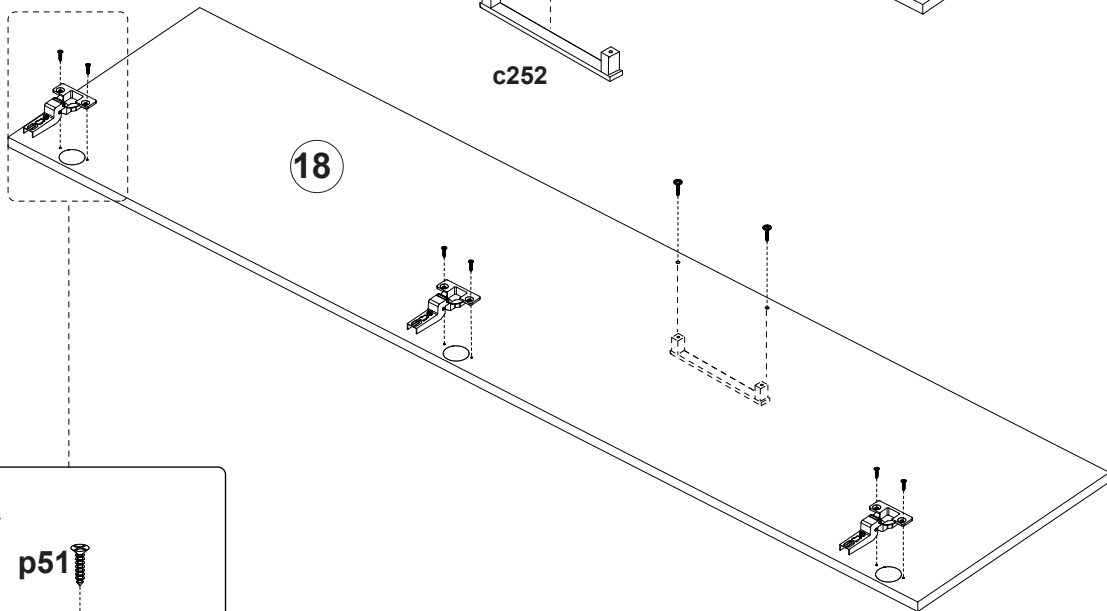
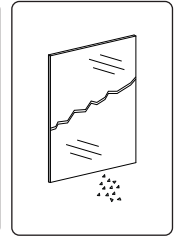
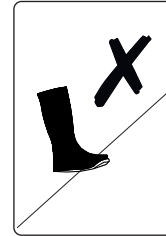
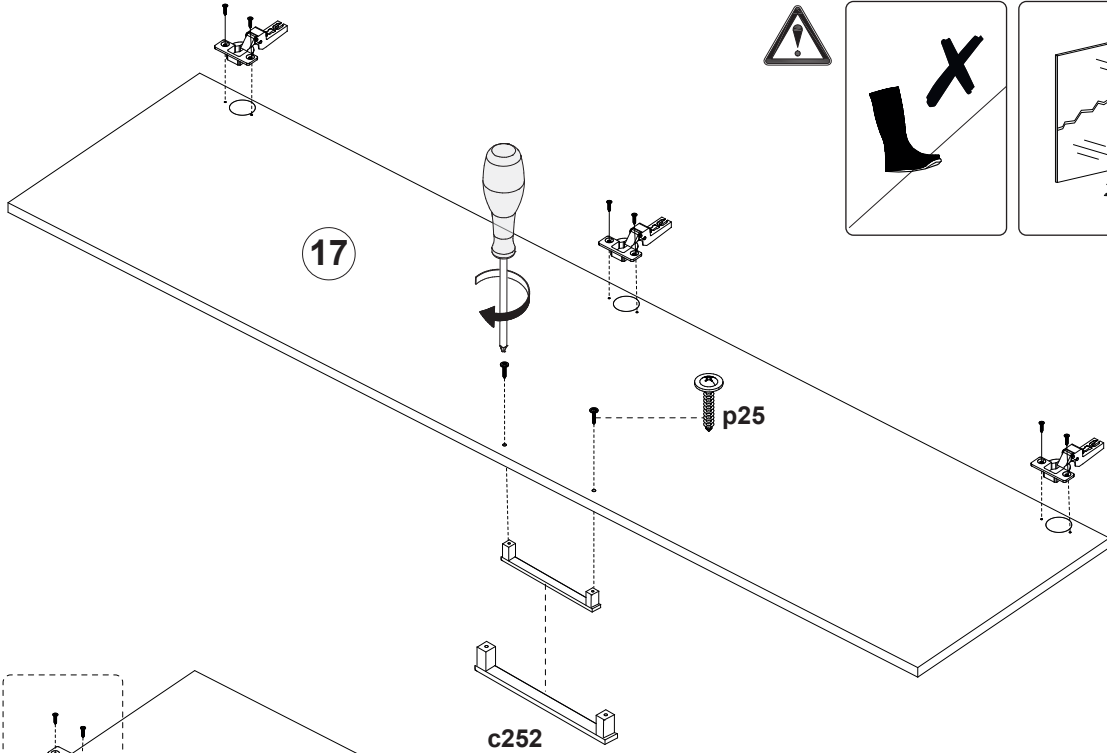
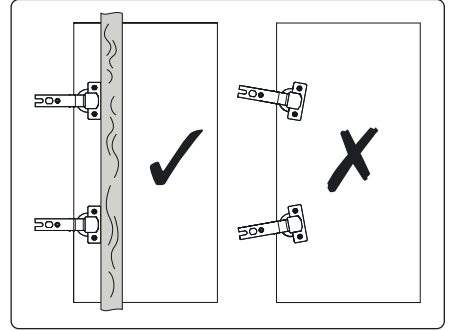

15

d1 x 2



Ø 5mm

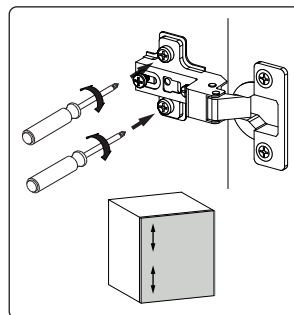
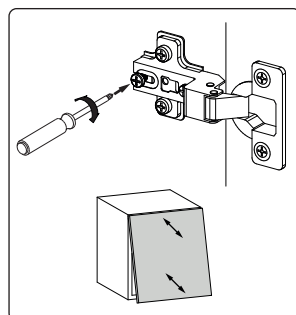
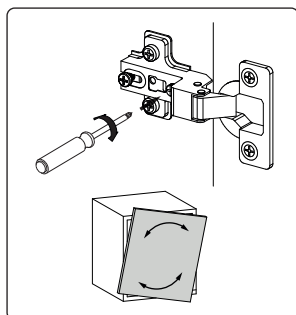
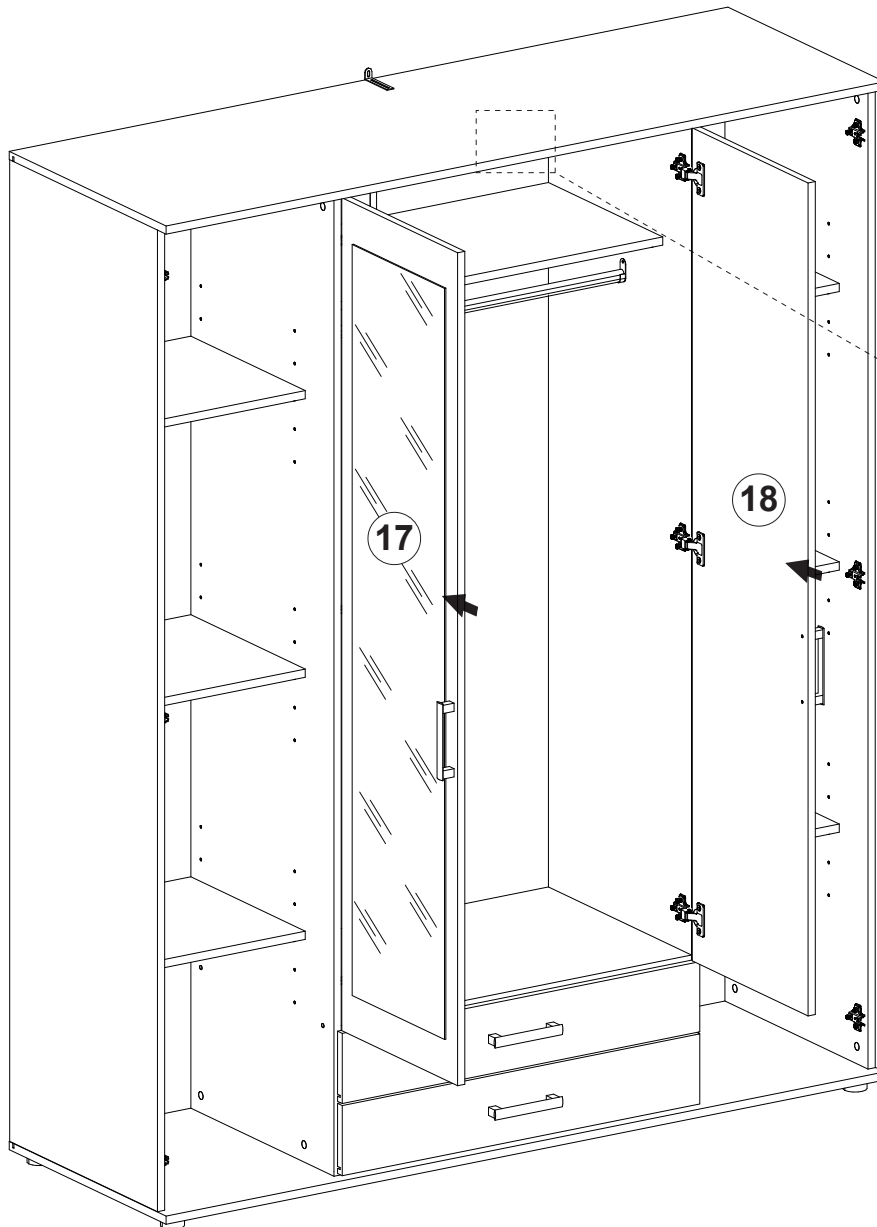
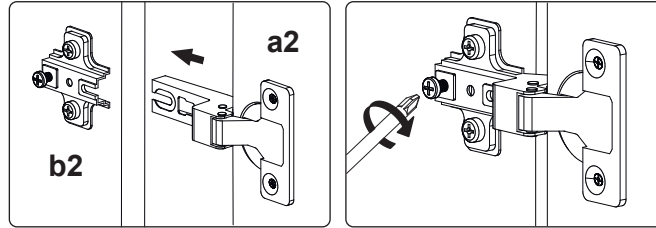

16

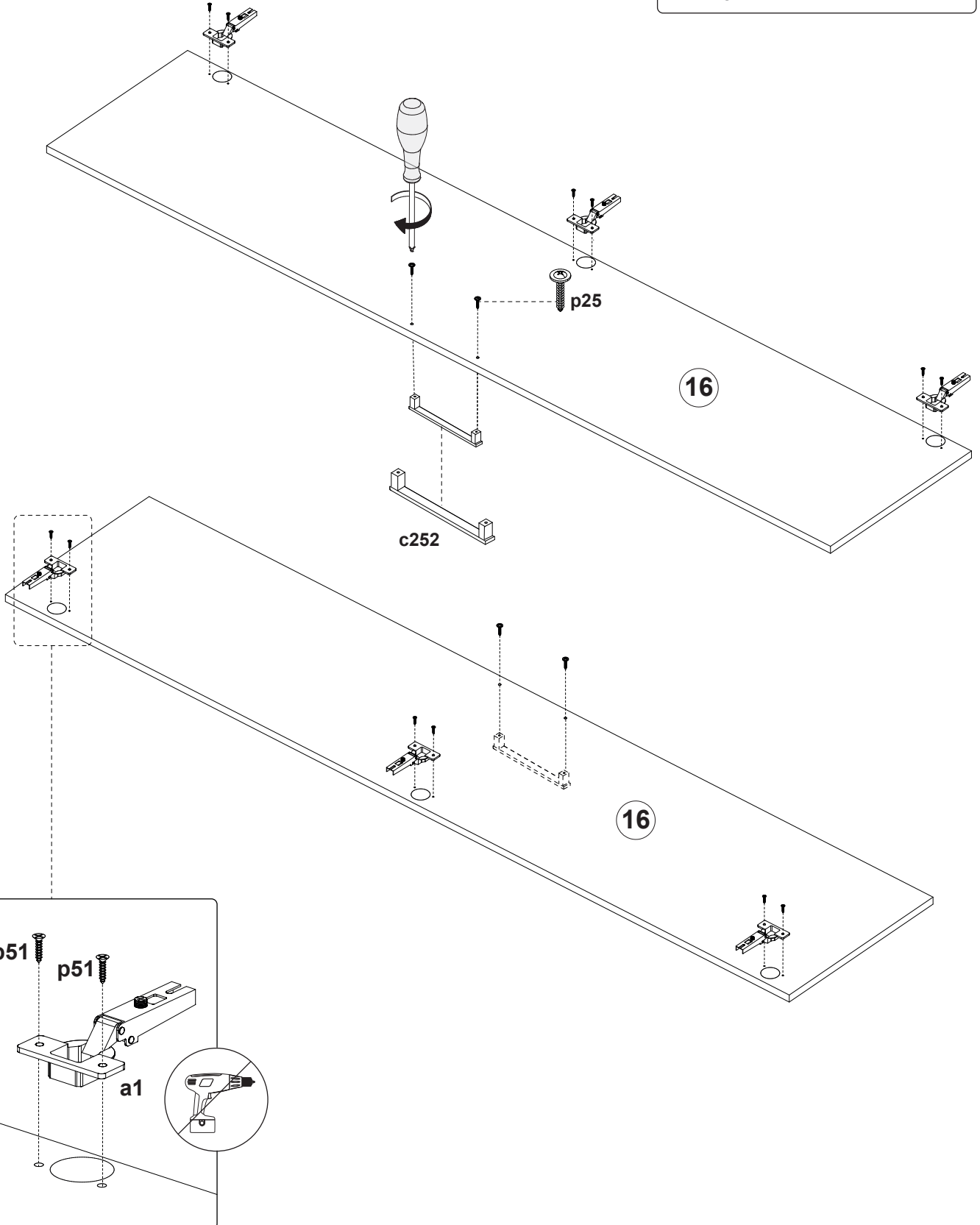
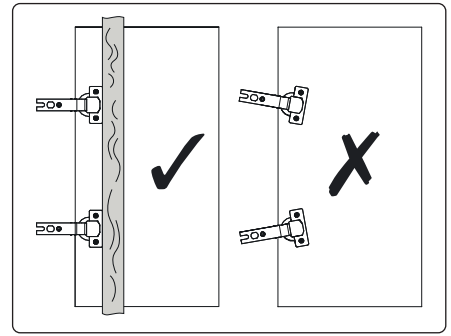
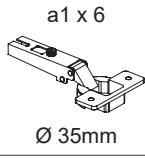
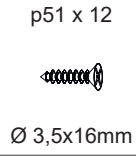
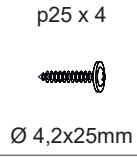
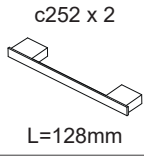

17

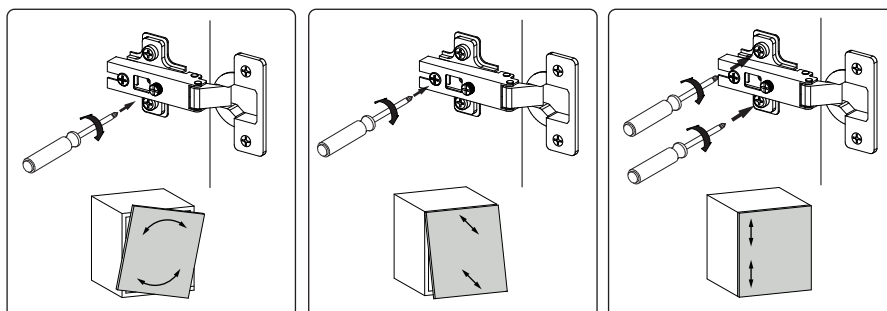
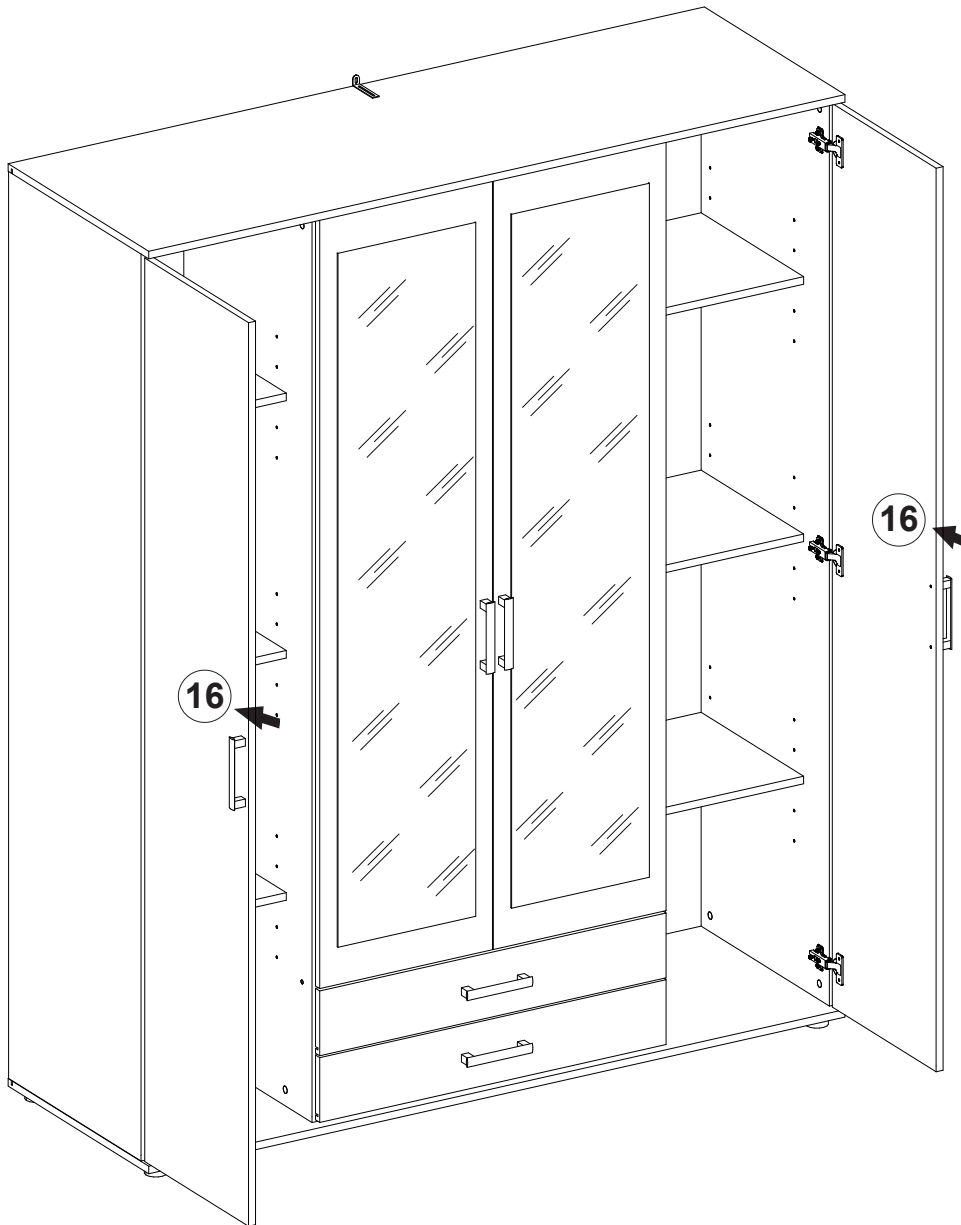
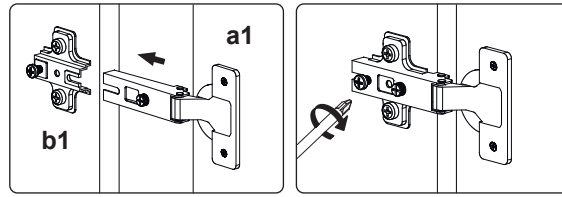

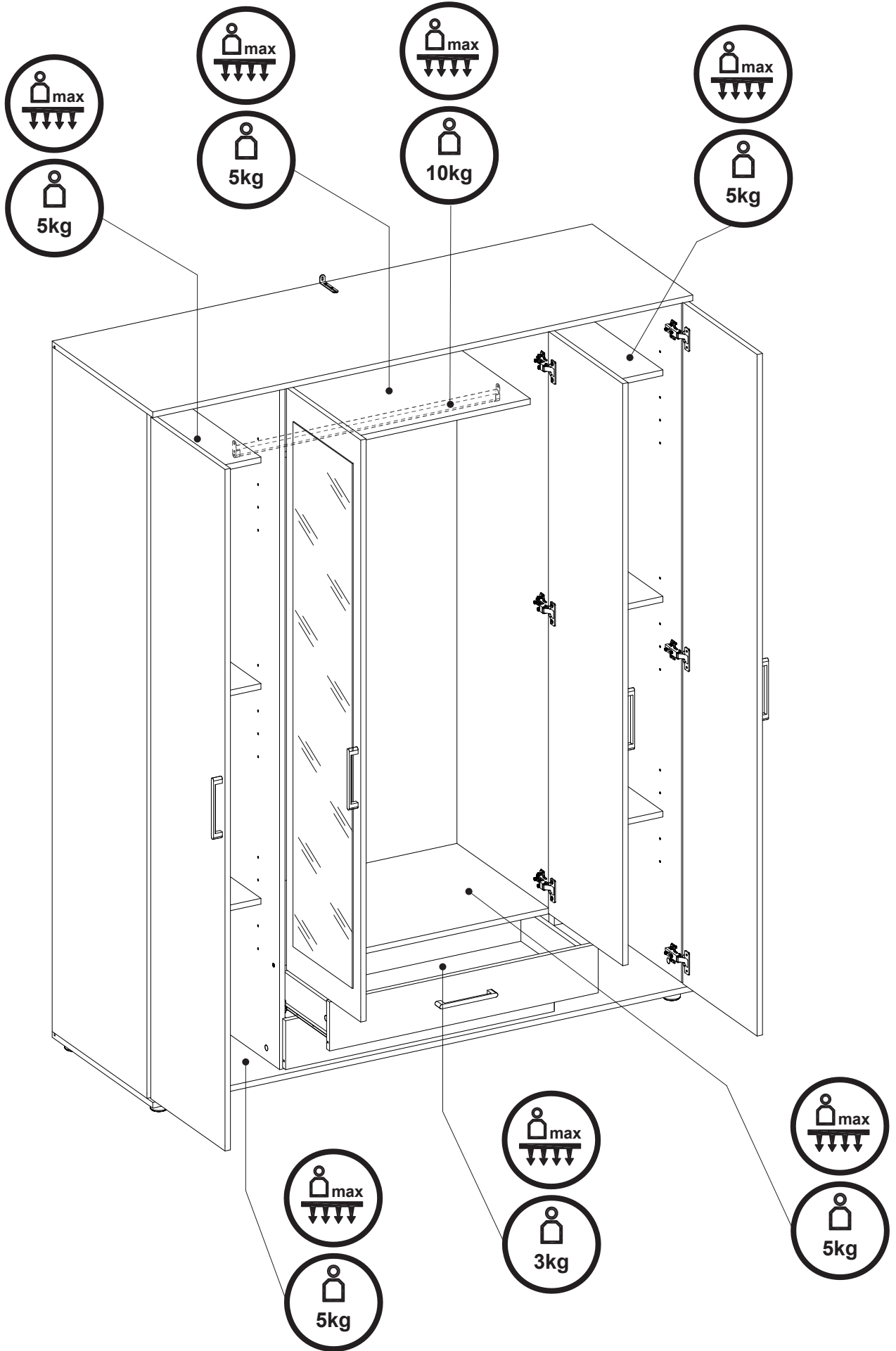

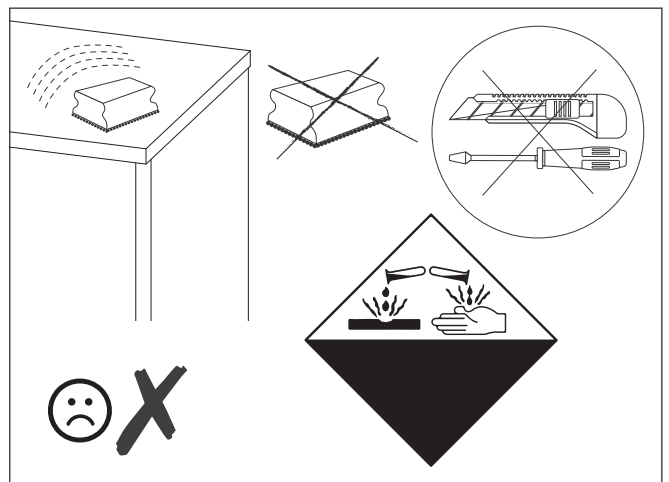
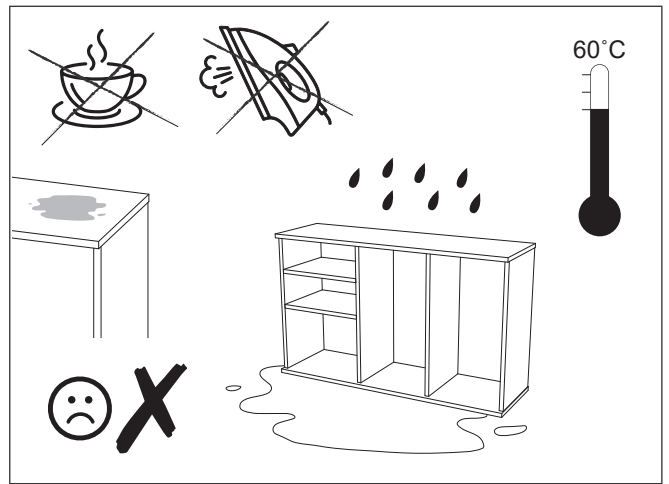
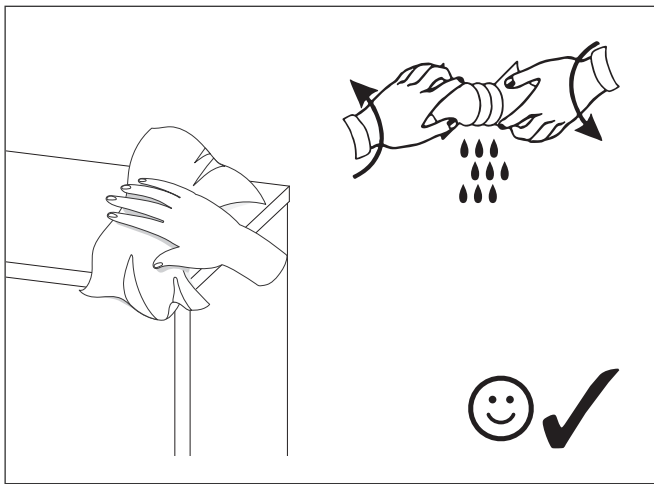
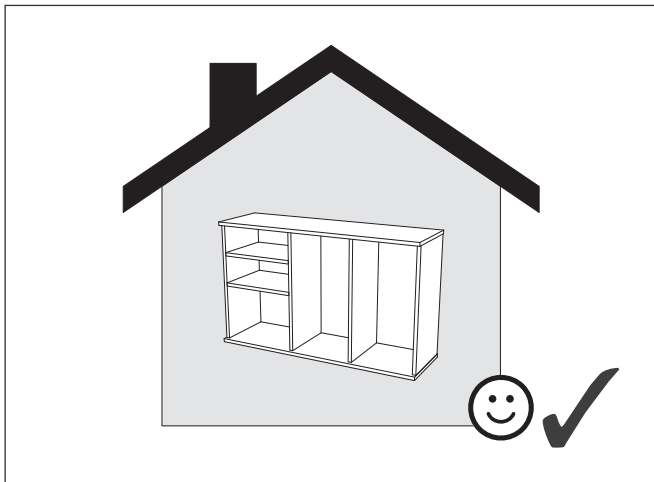

- PL** Powierzchnię mebli należy czyścić tylko środkami do pielęgnacji mebli. Szanowny kliencie w przypadku reklamacji prosimy wypełnić druki reklamacyjne dostępne w punktach sprzedaży przedkładając Kartę Reklamacyjną (zawierającą datę produkcji i numer pakowacza lub zmiany pakowania) umieszczoną w każdej z paczek, oraz instrukcję montażu mebla, gdzie prosimy o zaznaczenie uszkodzonego elementu.
- SK** Povrch nábytku čistite iba prostriedkami určenými na ošetrovanie nábytku. Vá ení zákazníci! V prípade reklamácie prosíme, aby ste vyplnili tlačivá, ktoré sú prístupné v obchodoch, predlo ili Reklamačný list (ktorý obsahuje dátum výroby a číslo baliča alebo číslo zmeny pri balení), ktorý sa nachádza v ka dom balení a návod na montáž nábytku, v ktorom označte poškodenú čas.
- CZ** Povrch nábytku čistěte pouze přípravky určenými k ošetrování nábytku. Vá ený zákazníkú, v případě uplatnění reklamacie vyplňte prosím reklamační formuláře, které jsou dostupné v prodejnách a předlo te Reklamační kartu (obsahující datum výroby a číslo balení nebo změny balení, která je umístěna v balíčku) a návod k obsluze s vyznačením poškozeného dílu.
- BG** Повърхността на мебелите трябва да се почиства само с препарати за поддържане на мебели. Уважаеми клиенти, в случай на рекламация моля попълнете формулярите за рекламация, които ще получите в търговските пунктове, като представите Картата за рекламация (съдържаща датата на производство и номера на опаковчика или смяната за опаковане), която ще намерите във всяка опаковка, и инструкцията за монтаж на мебела, върху която да отбележите повредения елемент.
- RO** Suprafața ei trebuie să fie curățată numai cu substanțe destinate pentru curățarea mobilei. Stimată Cumpărător, în caz de reclamație vă rugăm să completați formularul de reclamație pe care îl puteți lua de la punctul de vânzare și pe care îl veți prezenta împreună cu Cartela de Garanție (care conține data producției și nr ambalatorului sau turei de ambalare), însoțită la fiecare ambalaj, precum și instrucțiunile de montaj ale mobilei, pe care vă rugăm să marcați elementul deteriorat.
- UA** Поверхню меблів потрібно чистити тільки засобами для догляду за меблями. Шановний клієнте для заяви рекламачії, просимо заповнити формуляр рекламачії, доступний у пунктах продажу, вказуючи рекламачійну карту (містить дату виробництва та номер пакувальника або зміни упаковки), прикладену до кожного пакету, а також інструкцію з монтажу меблів, на якій просимо позначити пошкоджений елемент.
- RUS** Поверхность мебели надо чистить только средствами для ухода за мебелью. Уважаемый клиент для заявления рекламации, просим заполнить формуляр рекламации, доступный в пунктах продажи, указывая Рекламационную карту (содержащую дату производства и номер упаковщика или смены упаковки), приложенную к каждому пакету, а также инструкцию по монтажу мебели, на которой просим обозначить поврежденный элемент.
- DE** Reinigen Sie den Möbelbereich nur mit Möbelpflege. Kunden, bei Beanstandung Bitte füllen Sie die Reklamationsformulare, die in den Verkaufsabteilungen erhältlich sind, vor dem Verkauf aus eine Reklamationskarte (mit Angabe des Produktionsdatums und der Anzahl der Personen, die die Waren verpacken, oder der Anzahl der Schichten) Verpackung), die in jeder Packung enthalten ist, und Halterungen, in denen Sie reichlich vorhanden oder beschädigt sind Elemente Reinigen Sie den Möbelbereich nur mit Möbelpflege. Kunden, bei Beanstandung.
- GB** Furniture surface must be cleaned only with furniture maintenance formulas. Dear Customer, should you wish to file a complaint, we would request you to fill in the complaint forms available in our outlets, submitting the Complaint Card (specifying the date manufactured, packaging employee/ shift code) enclosed in each of the packets, together with the Assembly Manual, where please highlight the faulty component.
- H** A bútorok felületét kizárólag a bútorápolószerekkel lehet tisztítani. Tisztelt Vásárló! Reklamáció esetén kérjük az eladási helyeken kapható reklamációs nyomtatványokat kitölteni a Reklamációs Lap (tartalmazza a gyártási dátumát és csomagoló számát vagy műszakszámát) bemutatásával, amely mindegyik csomagban található, valamint a bútor szerelési utasítását, amelyen kérjük a sérült elemet bejelölni szíveskedjék.
- FR** La surface des meubles ne peut être nettoyée qu'avec des produits pour l'entretien de meubles. Cher Client, en cas de réclamation, veuillez bien remplir des formulaires de réclamation accessibles dans les centres de vente en montrant le mode d'emploi pour monter le meuble. Nous vous demandons de bien vouloir y entourer l'élément en panne.
- ES** Limpiar la superficie de muebles exclusivamente con los agentes para el cuidado de los muebles. Estimado Cliente, en caso de reclamaciones, hagan favor de rellenar los formularios de reclamación disponibles en los puntos de venta, presentando las instrucciones de montaje de mueble, donde es necesario indicar un elemento estropeado.
- NL** Het oppervlak van meubels hoeft alleen te worden gereinigd door middel van meubelverzorging Beste klant voor de verklaring!
klacht, vul dan het klachtenformulier in dat beschikbaar is in de verkooppunten, met vermelding van: klachtenkaart (bevat de fabricagedatum en het nummer van de verpakker of verandering van verpakking), bevestigd aan elk pakket, evenals instructies voor het installeren van meubels, die we u vragen te markeren beschadigd item.
- IT** **Pulire le superfici dei mobili solo con gli appositi detergenti. Gentile Cliente, se desidera presentare un reclamo, Le chiediamo di compilare i moduli di reclamo disponibili presso i nostri punti vendita, presentando la Scheda di reclamo (specificando la data di produzione, l'imballaggio della merce o il numero di strati di imballaggio) allegata a ciascuna confezione, insieme al manuale di montaggio, dove si prega di evidenziare l'articolo difettoso.**