

Laetitia

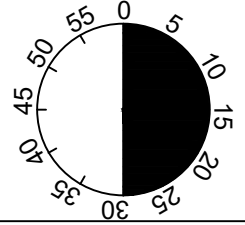

1

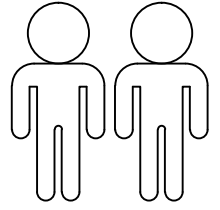
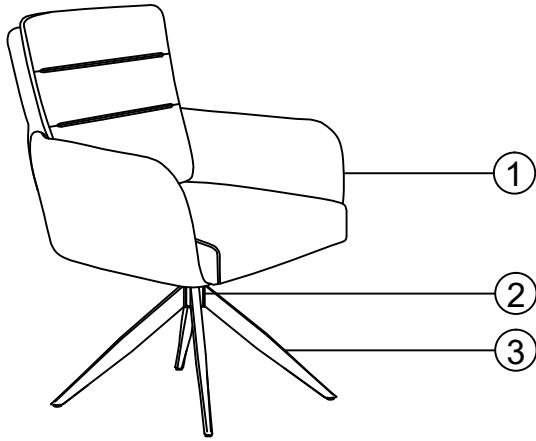
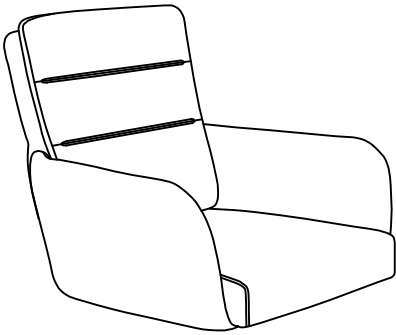

2

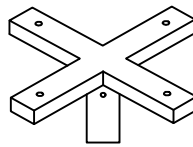

KP 120x120x85mm AR

3

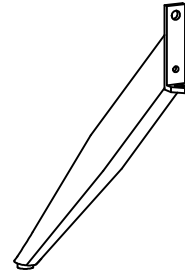

4

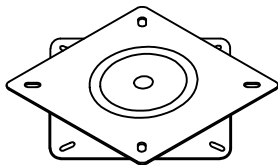





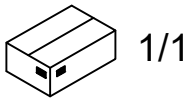

DT 180° AR 195X195mm

1	1x
2	1x
3	4x
4	1x

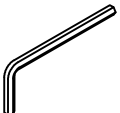
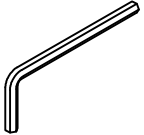

1/1

A	M6X13	B	M6X20	C	M8X16	D	M6	E	Ø18xØ6x1.5	F	4MM
											
4x		8x		4x		4x		12x		1x	
G	5MM	H	Ø17xØ6.5x4								
											
1x		2x									

I.

1

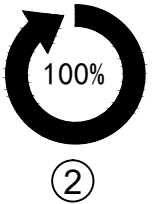
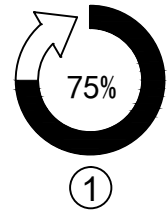
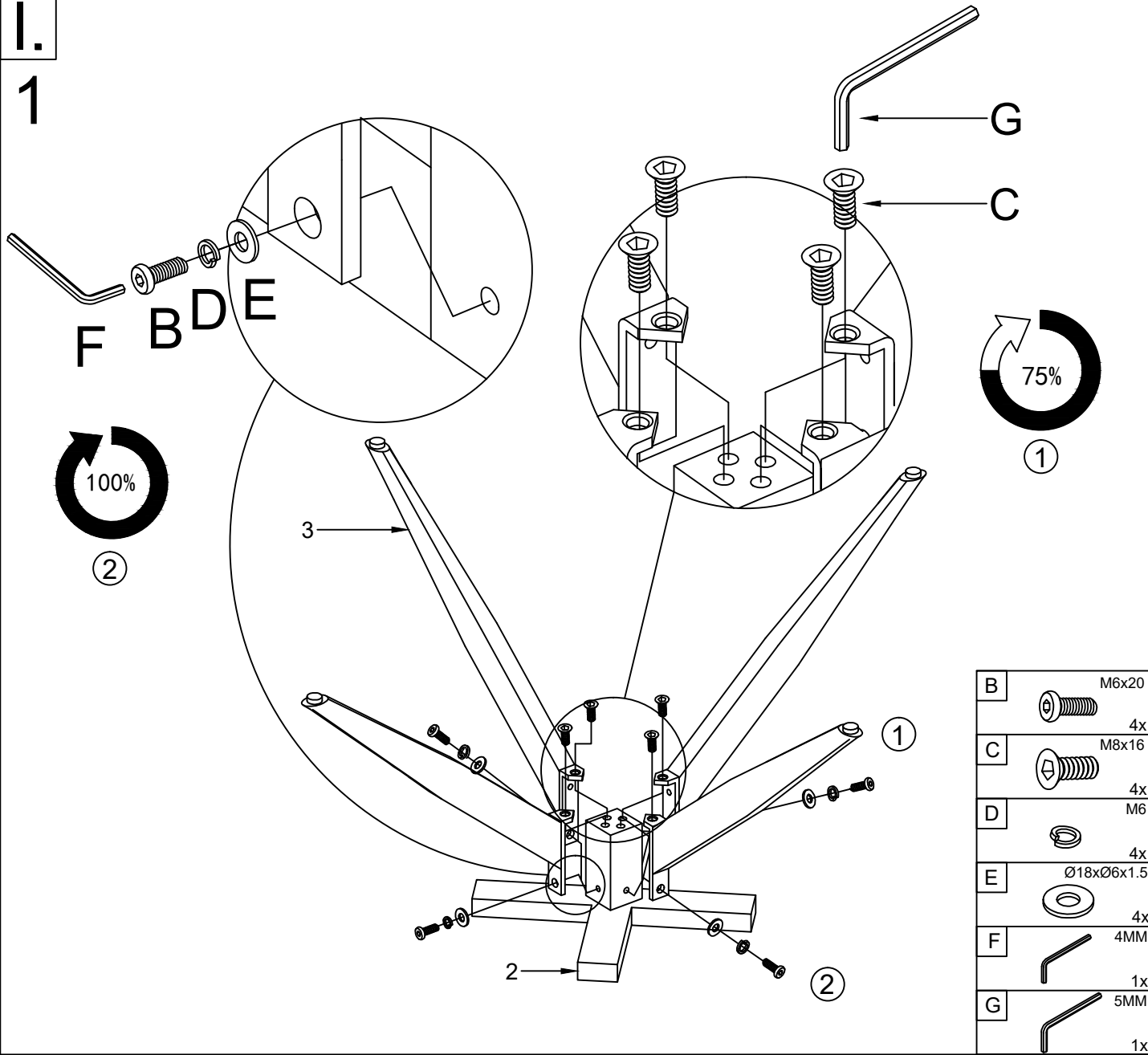

B	M6x20
	4x
C	M8x16
	4x
D	M6
	4x
E	Ø18xØ6x1.5
	4x
F	4MM
	1x
G	5MM
	1x

2

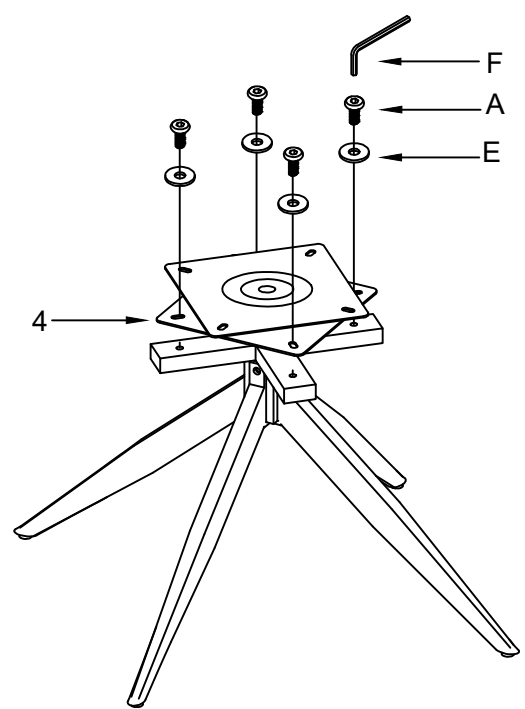



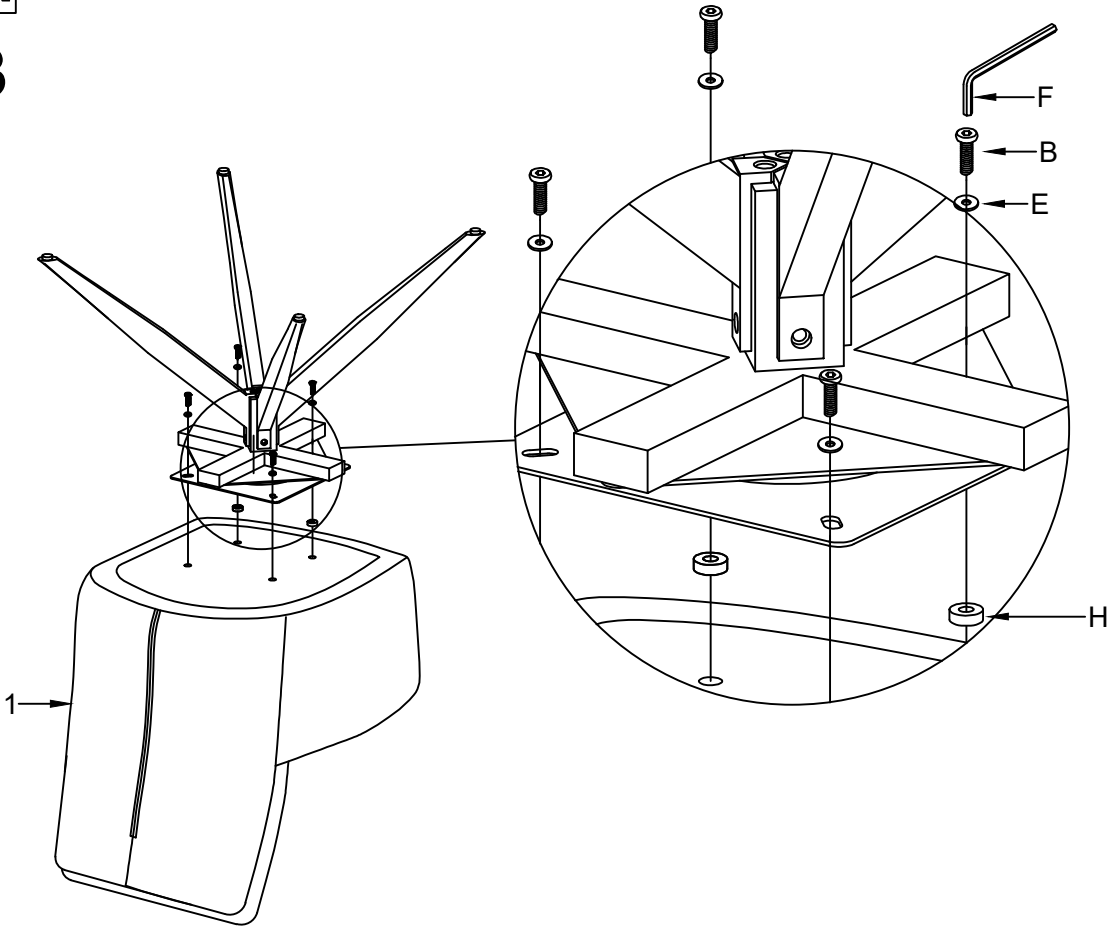

A	M6x13
	4x
E	Ø18xØ6x1.5
	4x
F	4MM
	1x
	100%

II.



3



B	M6X20
	
	4x
E	Ø18xØ6x1.5
	
	4x
F	4MM
	
	1x
H	Ø17xØ6.5x4
	
	2x
	

4



F	4MM
	
	1x
G	5MM
	
	1x
	