

MAGNETIC

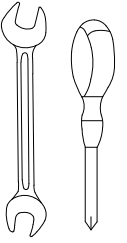

	L	W	H	Pcs
①	123	163	50	1x
②	123	190	50	1x

R

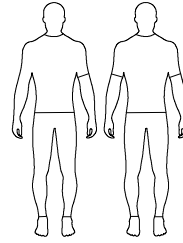
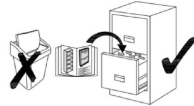
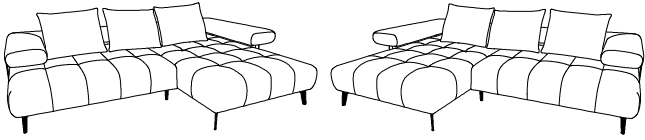
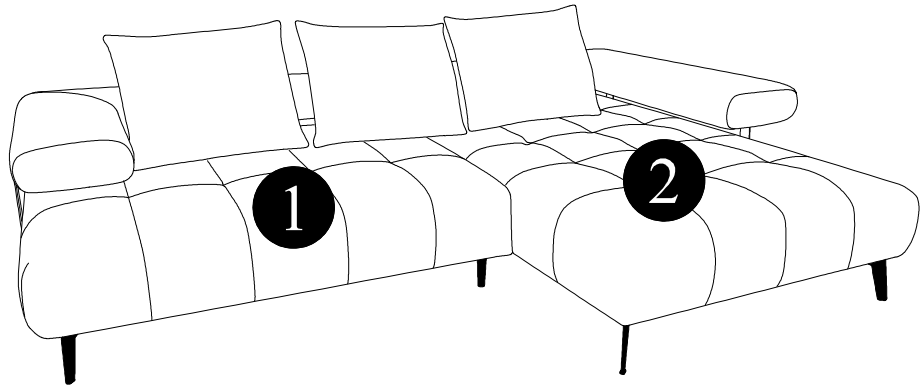

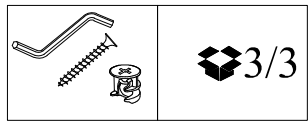
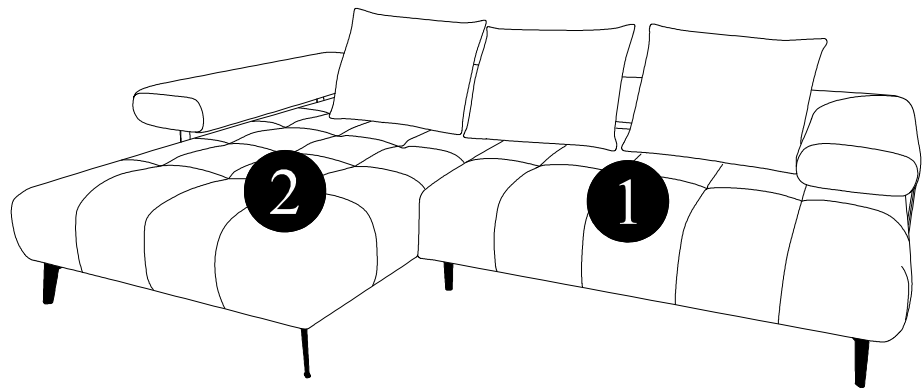

L



A  5x H-170	B  6x	C  2x H-170	D  12x M6	E  5x M6 X 40	F  1x M6 X 70	G  6x M6 X 60	H  12x M6 X 20	I  15x 5X30
----------------------	-------------	----------------------	--------------------	------------------------	------------------------	------------------------	-------------------------	----------------------

J  1x	K  3x 50x64
-------------	----------------------



B	H
	
6x	12x
M6 X 20	



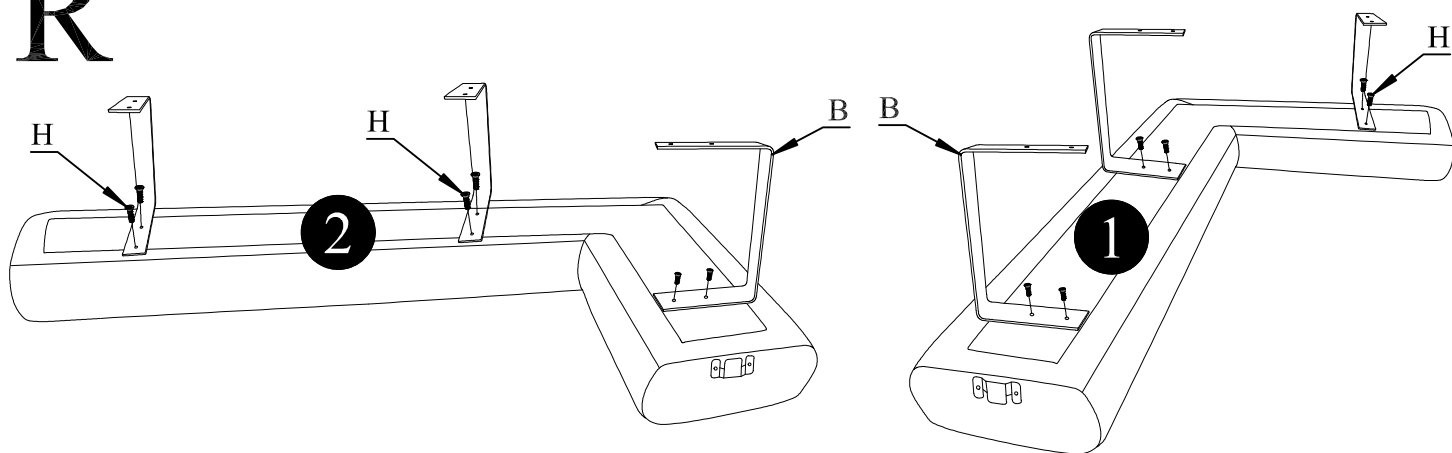

1

R

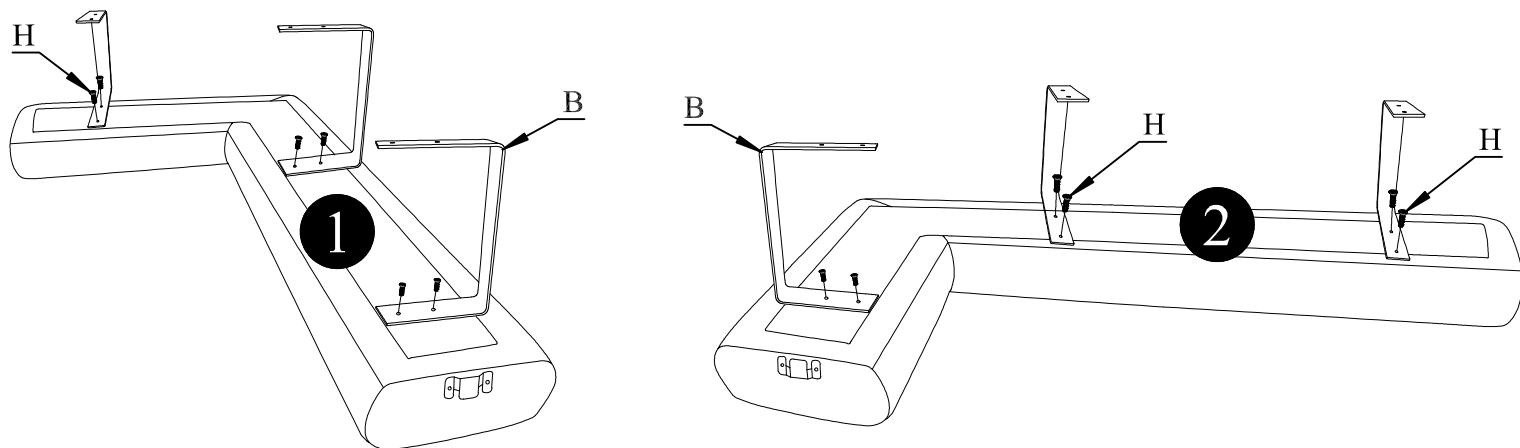

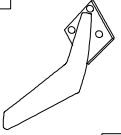
L

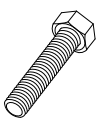
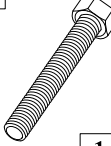

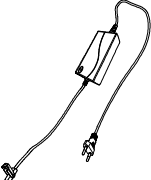

<b>A</b> 	<b>C</b> 	<b>D</b> 	<b>E</b> 	<b>F</b> 	<b>I</b> 	<b>J</b> 
2x	2x	6x	5x	1x	6x	
H-170	H-170	M6	M6 X 40	M6 X 70	5X30	

**L**

**2**

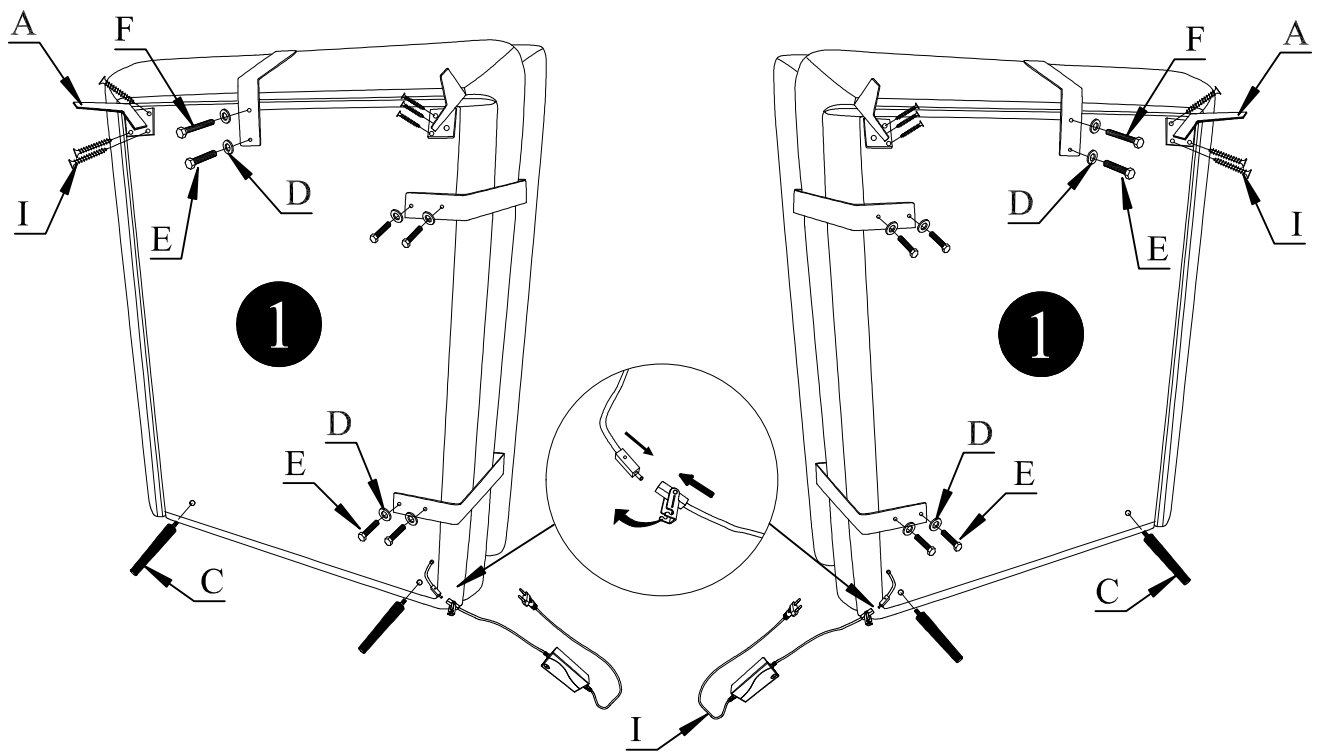
**R**

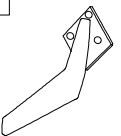
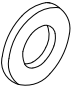

<b>A</b> 	<b>D</b> 	<b>G</b> 	<b>I</b> 
3x	6x	6x	9x
H-170	M6	M6 X 60	5X30

**3**

**L**

**R**

