

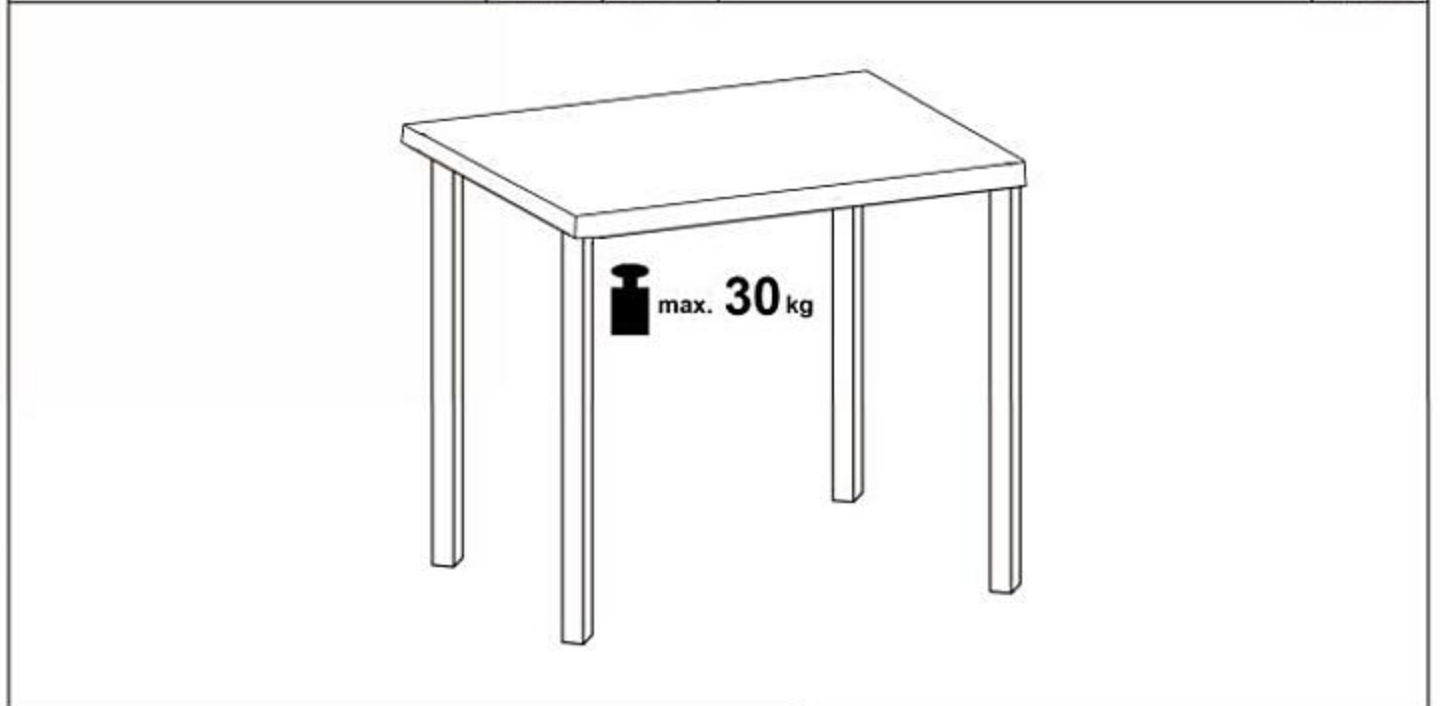

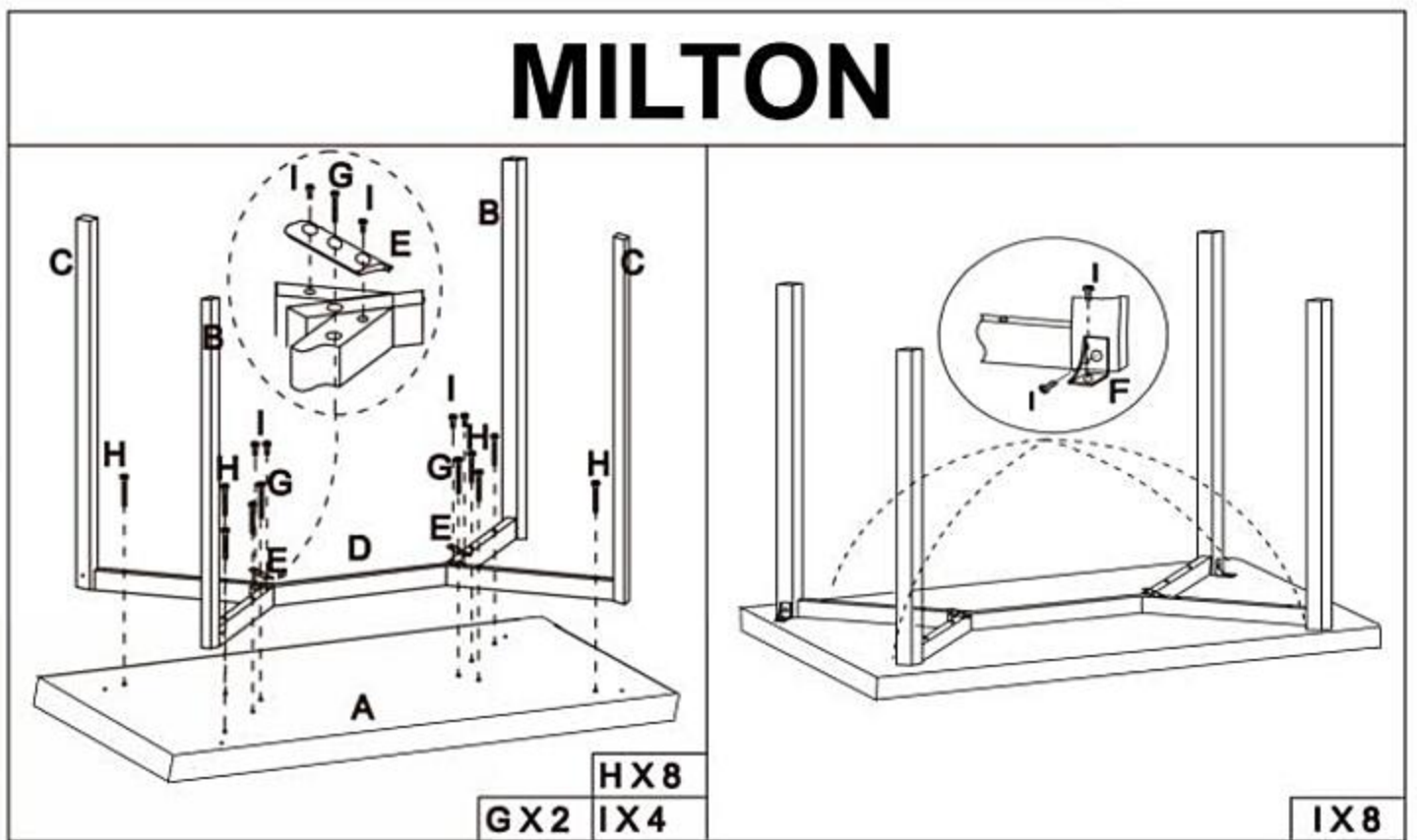







MILTON

A		1
B		2
C		2
D		1
E		2
F		4
G		2
H		8
I		12
		1

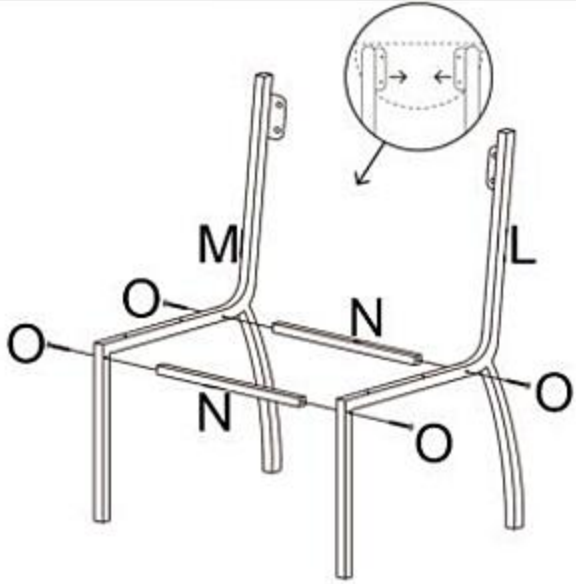

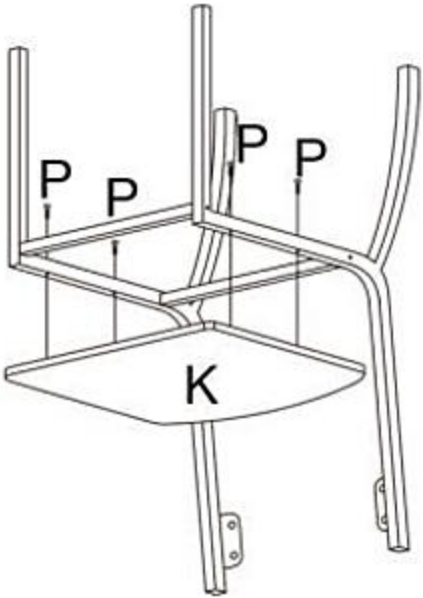
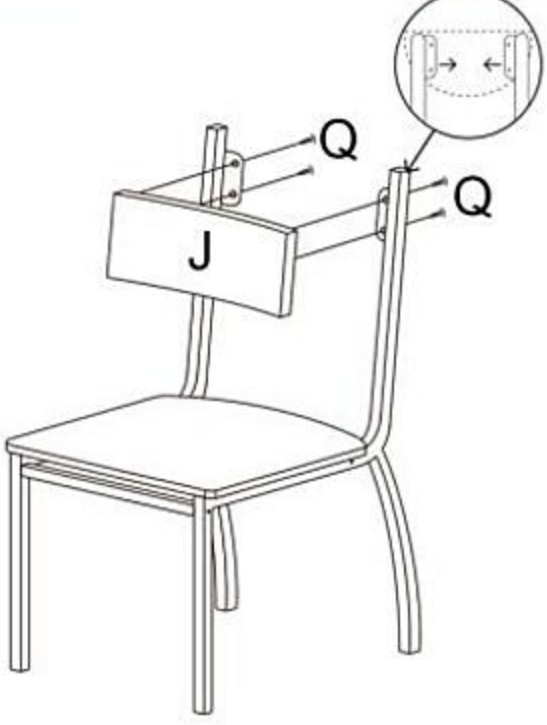
HALMAR Sp. z o.o.
 ul. Centralnego Okręgu Przemysłowego 2, 37-450 Stalowa Wola, POLSKA / POLAND
 tel. +48 15 843 28 10, fax: +48 15 842 19 57, e-mail: office@halmar.com.pl

1
 NOWOŚĆ

J		4	<h1>MILTON</h1>	
K		4		
L		4		1 
M		4		
N		8	2 	3 
O	 6x45mm	16		
P	 6x35mm	16		
Q	 4x12mm	16		