

MONTÁŽNÍ/MONTÁŽNY
NÁVOD IRIS

TV- stolek
TV- stolík

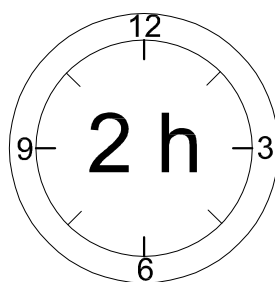
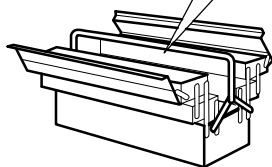
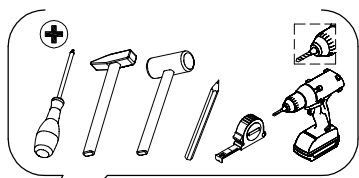
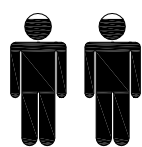
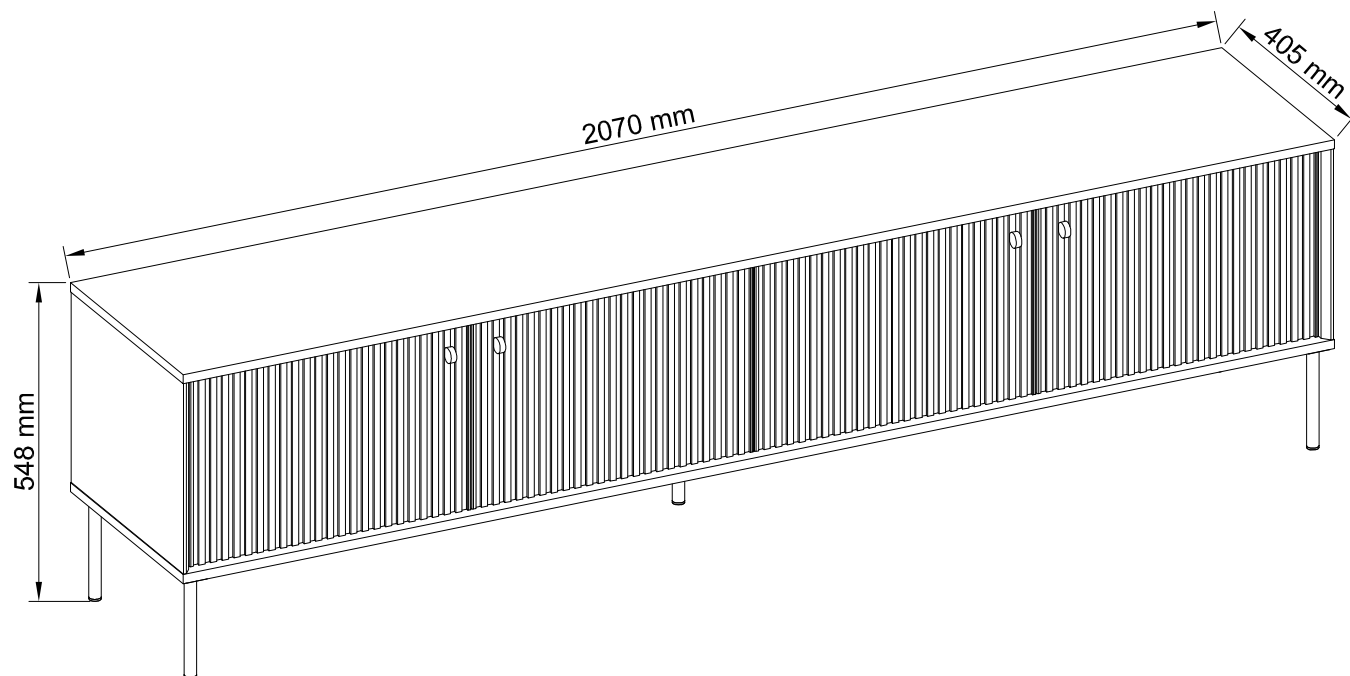

D-Ziehen Sie alle Schrauben sowie tragende Verbindungsteile nach ca. 5 Wochen nach, um ein dauerhafte Standsicherheit zu gewährleisten.

GB-After approx. 5 weeks, tighten all screws and load-bearing connecting parts to ensure permanent stability.

FR-Resserrez toutes les vis ainsi que les pièces de fixation au bout d'environ 5 semaines pour garantir une sécurité de fixation durable.

IT- Ristringere tutte le viti e giunture dopo ca. 5 settimane, al fine di garantire una durevole solidità.

NL-Draai alle schroeven en ook dragende verbindingstukken na ca. 5 weken nog eens vast, zodateen continue stabiliteit wordt gegarandeerd.

PL-Prosimy po ok. 5 tygodniach dokręcić wszystkie śruby i elementy łączeniowe. Zagwarantuje to Państwu trwałość i stabilność połączeń.

CZ- Dotáhněte všechny šrouby a nosné spojovací díly přibližně po 5 týdnech, aby se zaručila trvalá stabilita.

SK-Po cca 5 týždňoch dotiahnite skrutky, aby bola zaručená ich trvalá stabilita.

HU-Húzza utána - kb. 5 hét múlva - az összes csavart és a teherhordó összekötő-alkatrészeket abiztonság érdekében.

RO-Pentru a asigura o stabilitate de durată, strângeți după cca. 5 săptămâni toate șuruburile, precumși toate elementele portante de legătură.

TR-Tüm vida ve taşıyıcı bağlantı parçalarını kalıcı bir duruş güvenliğini sağlamak için yaklaşık 5 haftasonra tekrar sıkınız.

RU - Подкрутите все болты, а также несущие соединительные детали припл. через 5 недель для обеспечения устойчивости в течение длительного времени.

SRB - Molim vas после акрокса. 5 недеља затегните све шрафове и причвршћиваче. То ће вам гарантовати трајност и стабилност веза.

HR - Molim vas, nakon cca. 5 tjedana zategnite sve vijke i pričvršćivače. To će vam jamčiti trajnost i stabilnost priključaka.

SL - Pýtame sa po cca. 5 týždňov utiahnite všetky skrutky a upevňovacie prvky. To zaručuje trvanlivosť a stabilitu spojov.

LT - Mes prašome po maždaug. 5 savaites priveržkite visus varžtus ir tvirtinimo detales. Taip užtikrinamas jungčių patvarumas ir stabilumas.

LV - Mēs lūdzam pēc apm. 5 nedēļas, pievelciet visas skrūves un stiprinājumus. Tas garantē savienojumu izturību un stabilitāti.

EE - Küsime pärast ca. 5 nädalat, pingutage kõiki kruvisid ja kinnitusi. See tagab ühenduste vastupidavuse ja stabiilsuse.

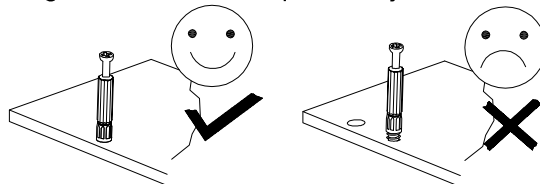

D Bitte nur mit einem Staubtuch oder leicht feuchtem Lappen reinigen. Keine scheuernden Putzmittel verwenden.

GB Please only clean with a duster or a damp cloth. Do not use any abrasive cleaners.

FR Veuillez nettoyer uniquement avec un chiffon à poussière ou un chiffon légèrement humide. N'apas utiliser de détergent abrasif.

IT Si raccomanda di pulire solo con un panno per la polvere o uno strofinaccio umido. Non utilizzare detersivi abrasivi.

NL Reinig alleen met een stofdoek of een lichtjes vochtige doek. Gebruik geen schurende poetsmid-delen.

PL Czyszczenie należy wykonać wyłącznie za pomocą ściereczki lub lekko nawilżonego ręcznika. Nie stosować środków czyszczących do szorowania.

CZ Čistěte prosím jen prachovkou nebo lehce navlhčeným hadrem. Nepoužívejte drhňoucí čisticí prostředky.

SK Na čistenie používajte len prachovku alebo zľahka navlhčenú utierku. Nepoužívajte žiadne drhňúce čistiace prostriedky.

HU Kérjük, csak portórló kendővel vagy enyhén nedves ronggyal tisztítsa. Ne használjon dörzshatású tisztítószeret.

RO Vă rugăm să utilizați la curățare exclusiv o cârpă de șters praful sau o cârpă ușor umezită. Nu utilizați substanțe de curățat abrazive.

TR Lütfen sadece bir toz bezle veya hafif nemli yumuşak bir bezle siliniz. Aşındırıcı temizlik malze-meleri kullanmayınız.

RU Для чистки используйте, пожалуйста, тряпку для пыли или слегка влажную ветошь. Неиспользовать абразивные чистящие средства.

SBR Чишћење треба обавити само крпом или благо влажним пешкиром. Немојте користити средство за чишћење рибанја.

HR Čišćenje treba obaviti samo krpom ili blago navlaženim ručnikom. Ne koristite sredstva za čišćenje ribanja.

SL Čistenie by sa malo vykonávať len handričkou alebo ľahko navlhčeným uterákom. Nepoužívajte čistiace prostriedky na drhnutie.

LT Valyti galima tik šluoste arba lengvai sudrėkintu rankšluosčiu. Nenaudokite šveičiamųjų valiklių.

LV Tīršana jāveic tikai ar drānu vai viegli samitrinātu dvieli. Neizmantojiet tīršanas līdzekļus.

EE Puhastada tohib ainult lapiga või kergelt niisutatud rätikuga. Ärge kasutage puhastusvahendeid.

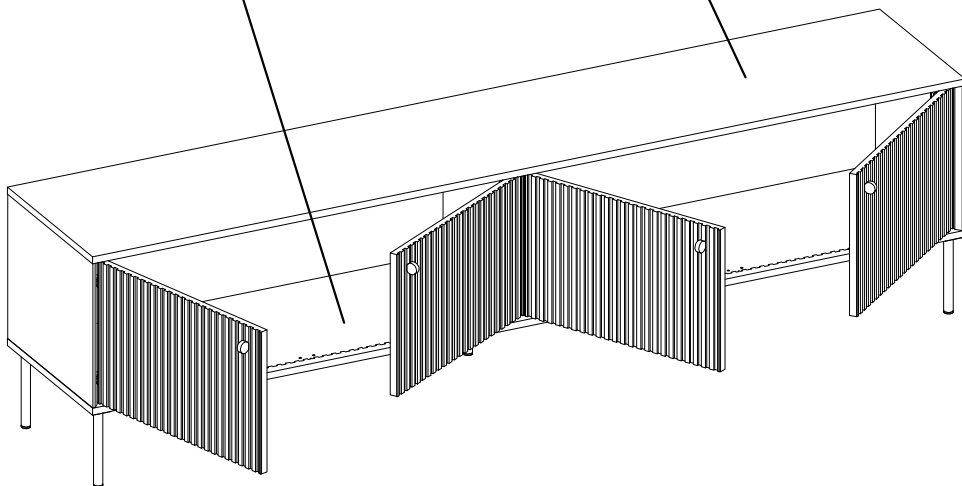
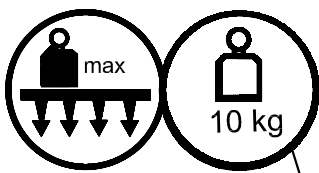
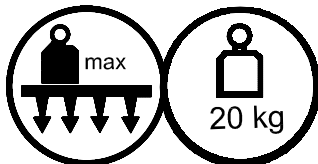
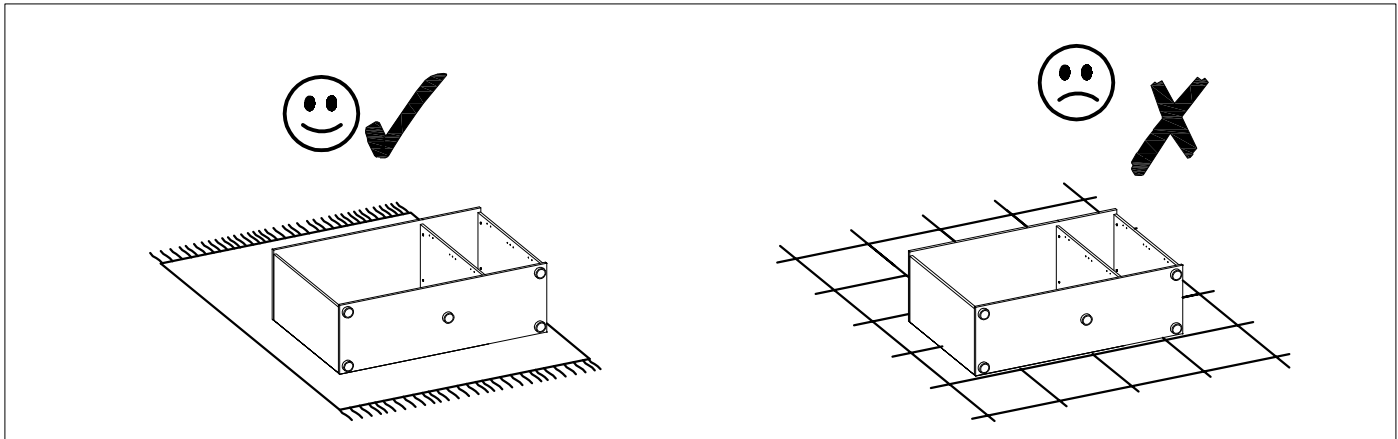
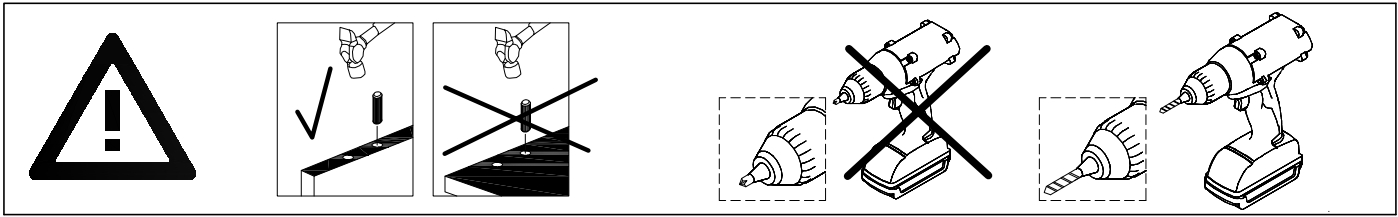
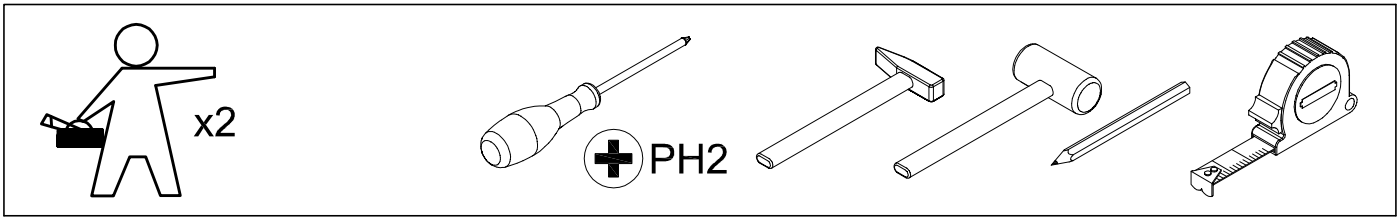

**Service · Assistenza · Dienstverlening · Serwis
Servis · Szerviz · Сервисная служба · Сервис · Serwis · Servis**

Name · Nom · Nome · Naam ·
Nazwa · Jméno · Názov · Név ·
Denumire · Isim · Название
Typ · Type · Típ · Tipus · Típo ·
Тип

Iris

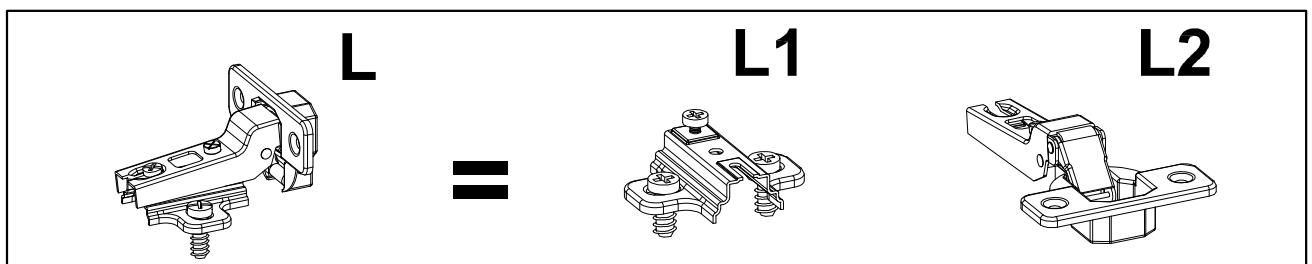
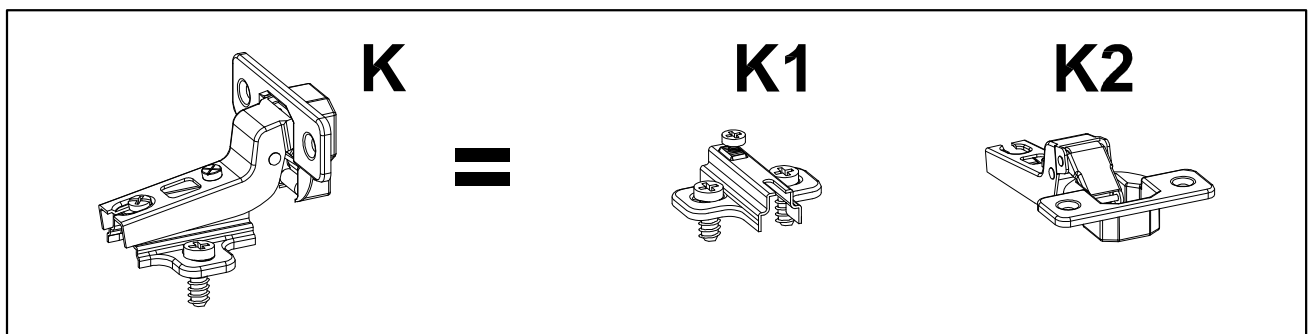
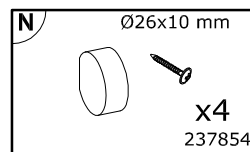
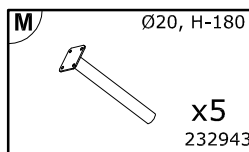
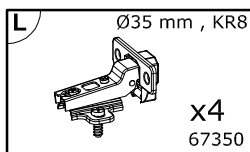
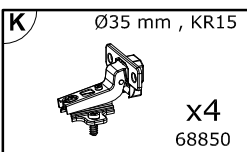
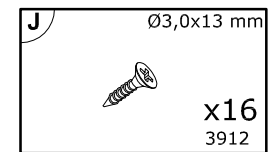
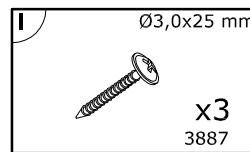
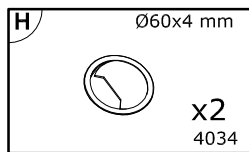
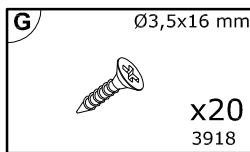
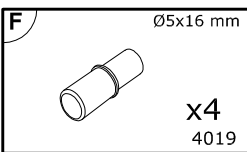
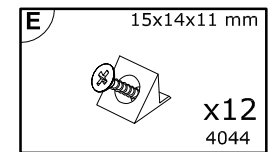
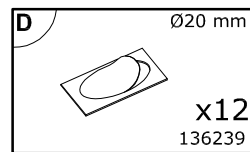
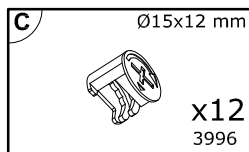
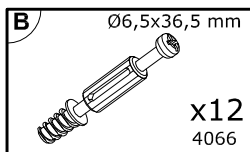
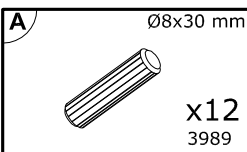
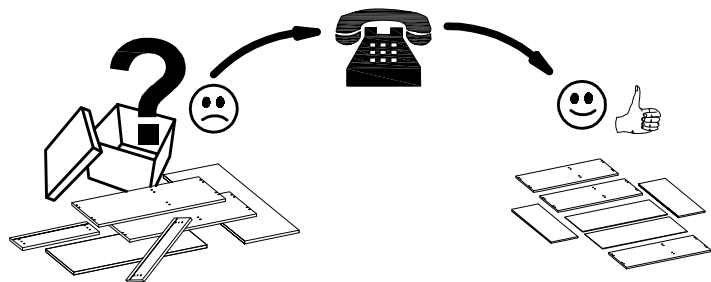
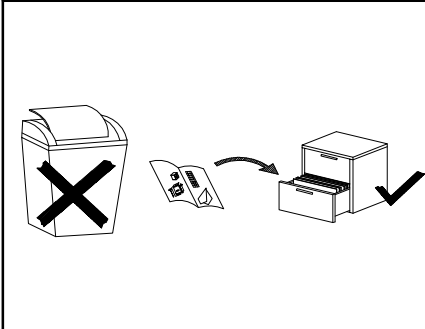

09

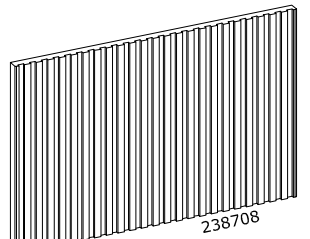
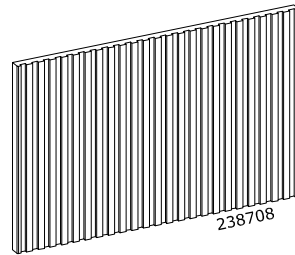
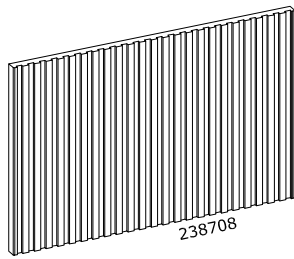
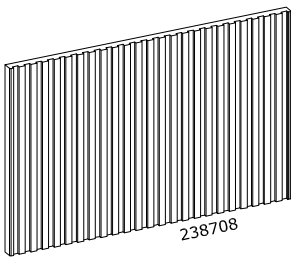
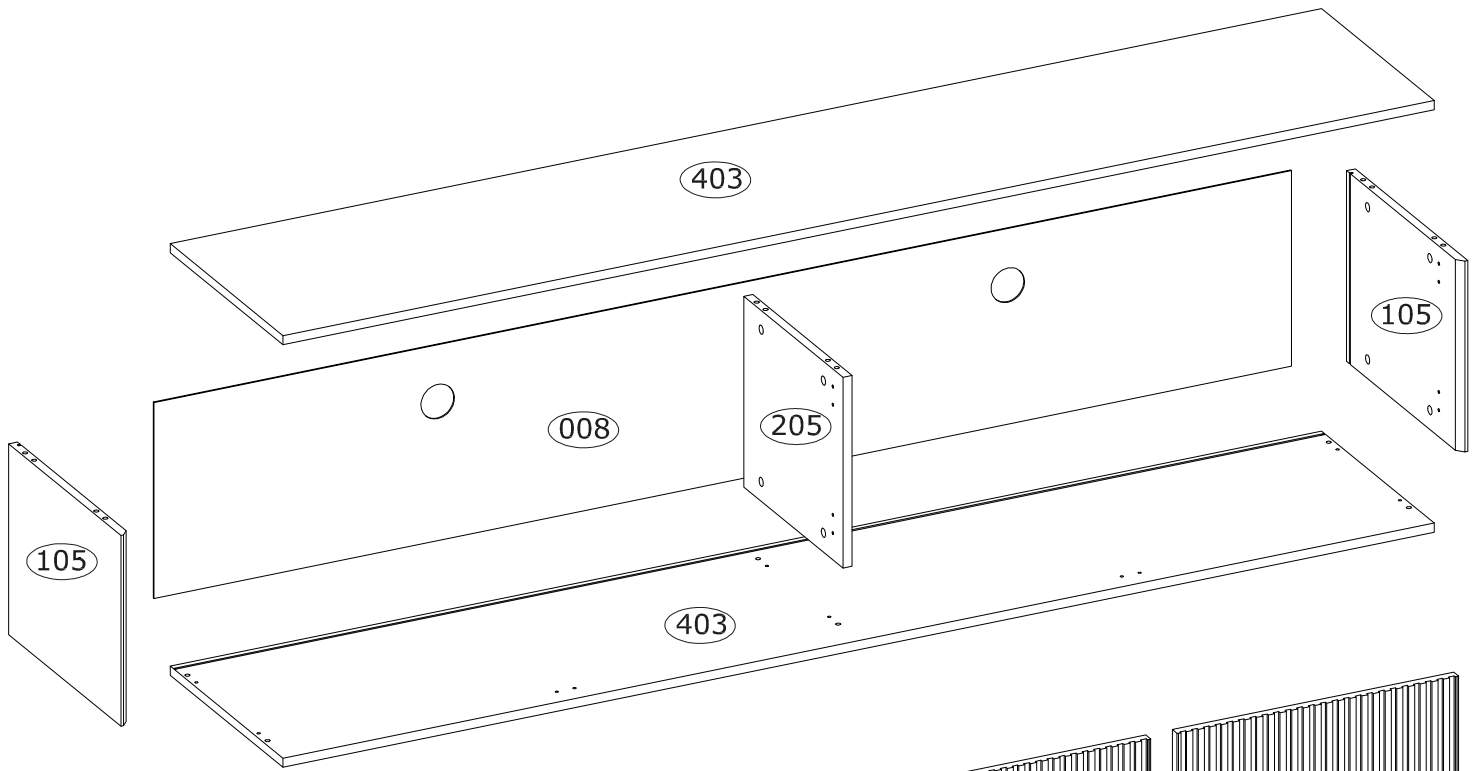

0
10
20
30
40
50
60
70
80
90
100
110
120
130
140
150
160
170
180
190
200

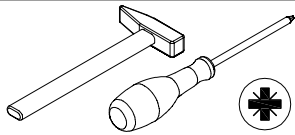
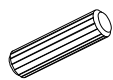
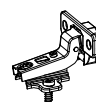

1

A	Ø8x30 mm	K	Ø35 mm , KR15	
	x8 3989		x2 68850	

x2

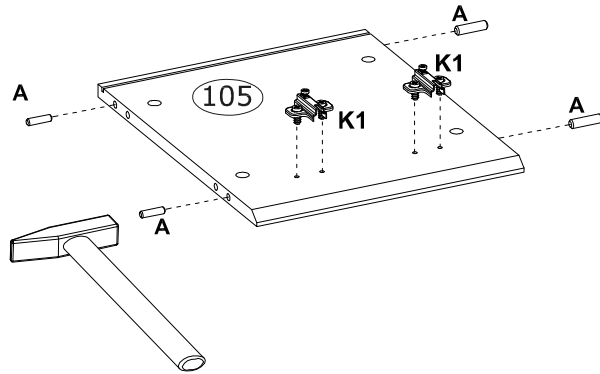

2

A	Ø8x30 mm	L	Ø35 mm , KR8	
	x4 3989		x4 67350	

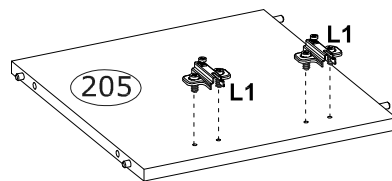
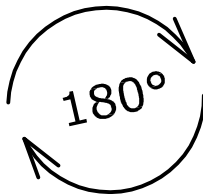
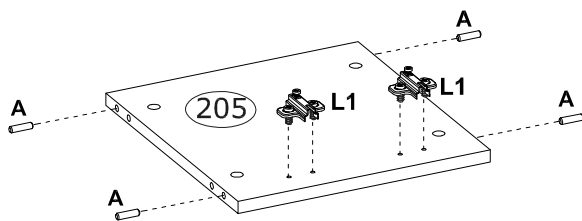

3

B Ø6,5x36,5 mm x6 4066	F Ø5x16 mm x4 4019
--	------------------------------------

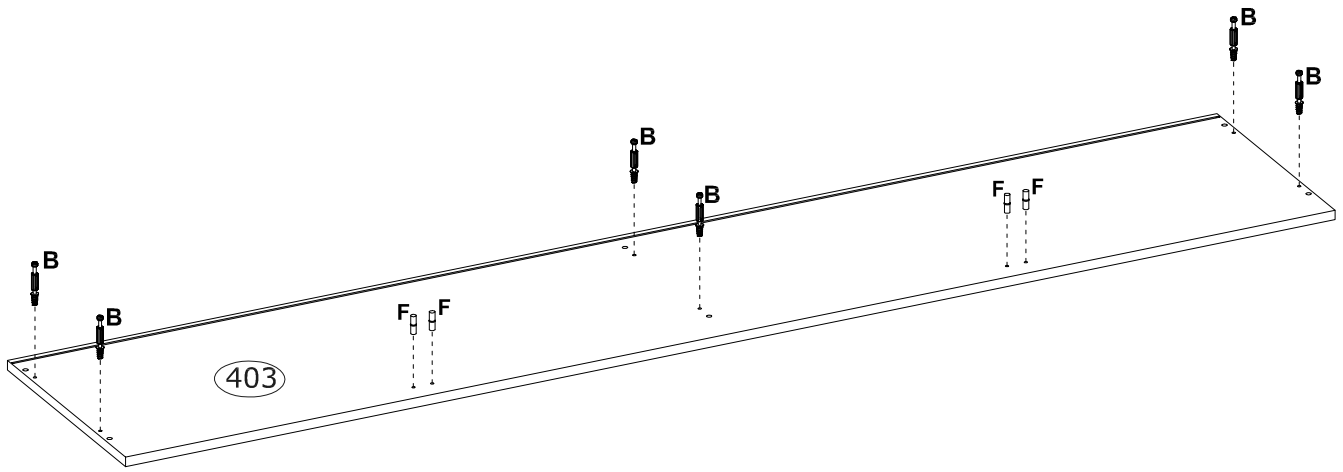
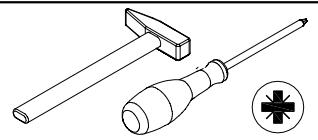

4

B Ø6,5x36,5 mm x6 4066
--

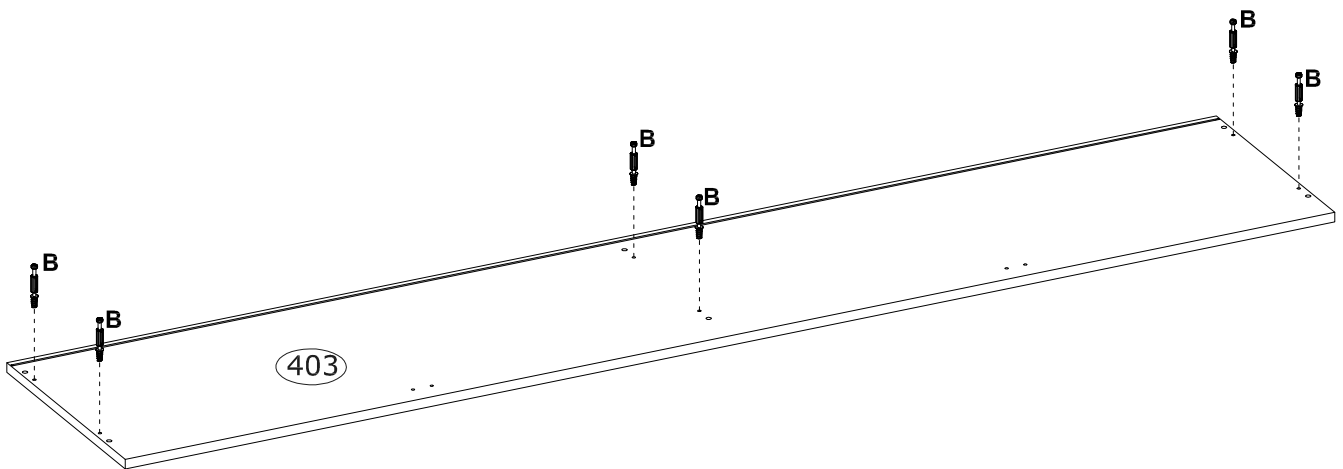
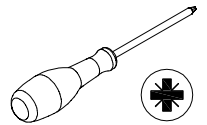

5

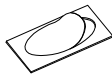
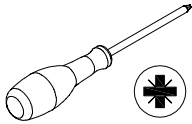
C Ø15x12 mm  x6 3996	D Ø20 mm  x6 136239	
--	---	--

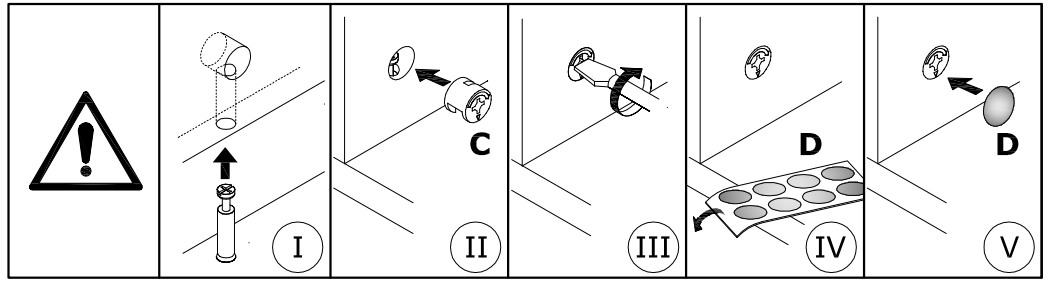
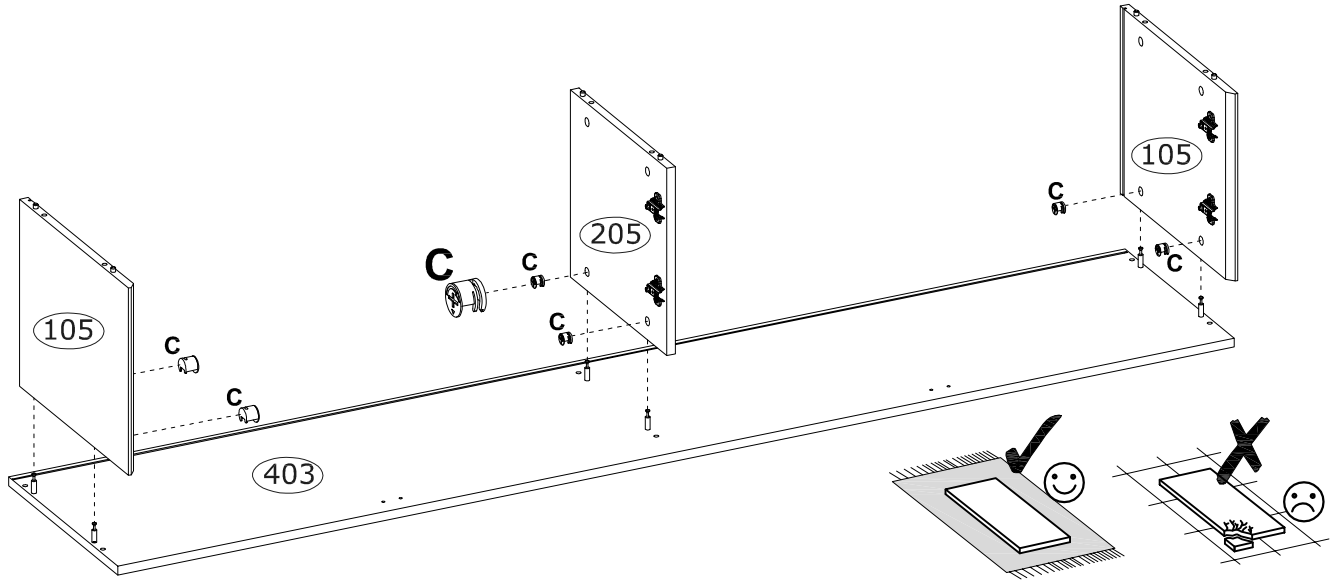

6

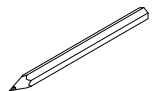
H Ø60x4 mm  x2 4034	
---	---

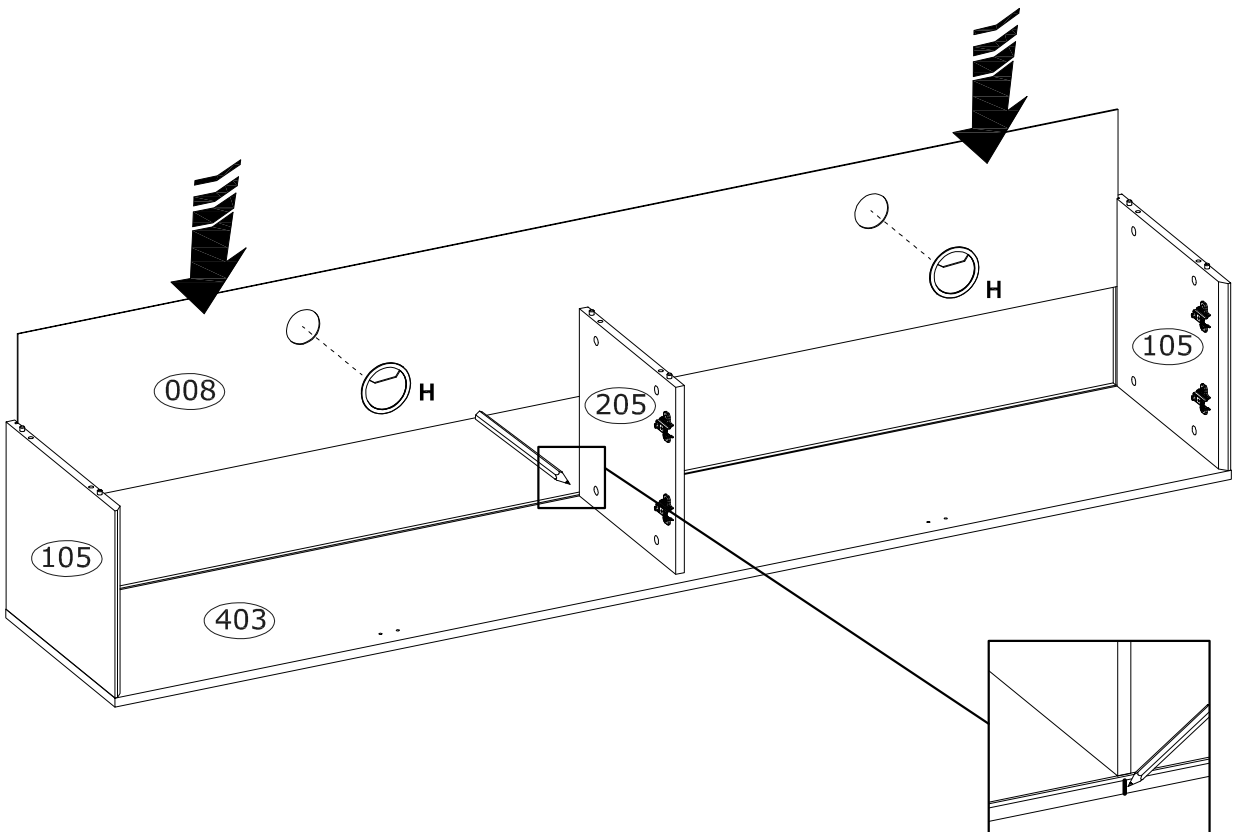

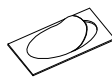
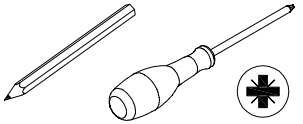

7

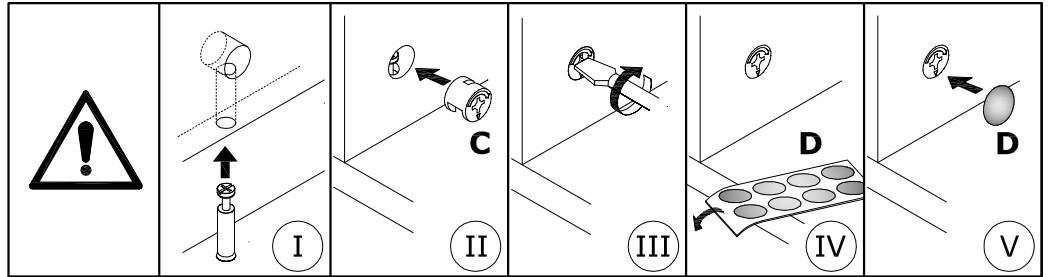
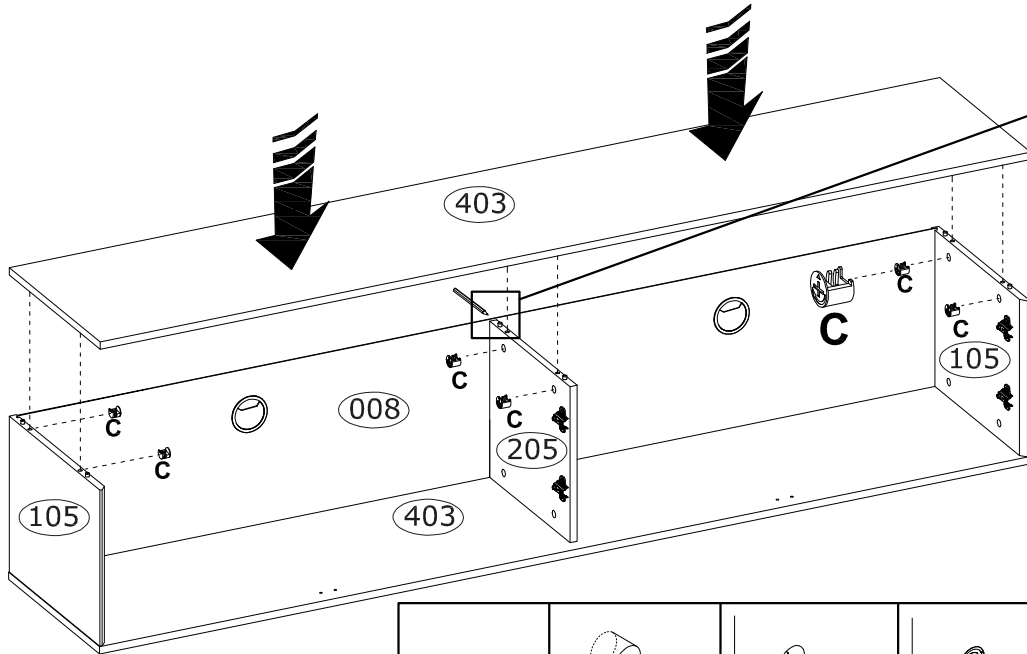
<p>C $\varnothing 15 \times 12$ mm</p>  <p>x6 3996</p>	<p>D $\varnothing 20$ mm</p>  <p>x6 136239</p>	
---	---	--



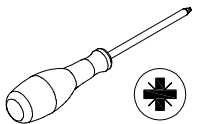

8

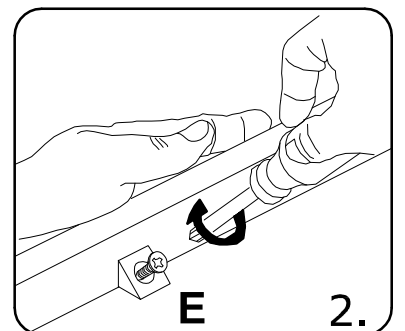
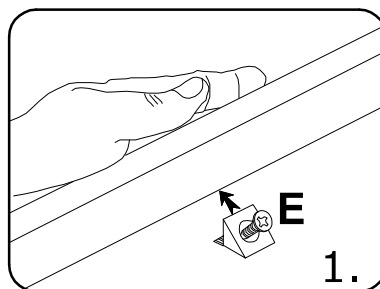
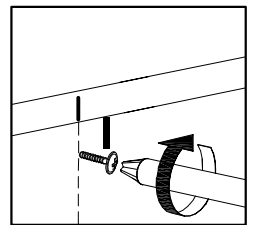
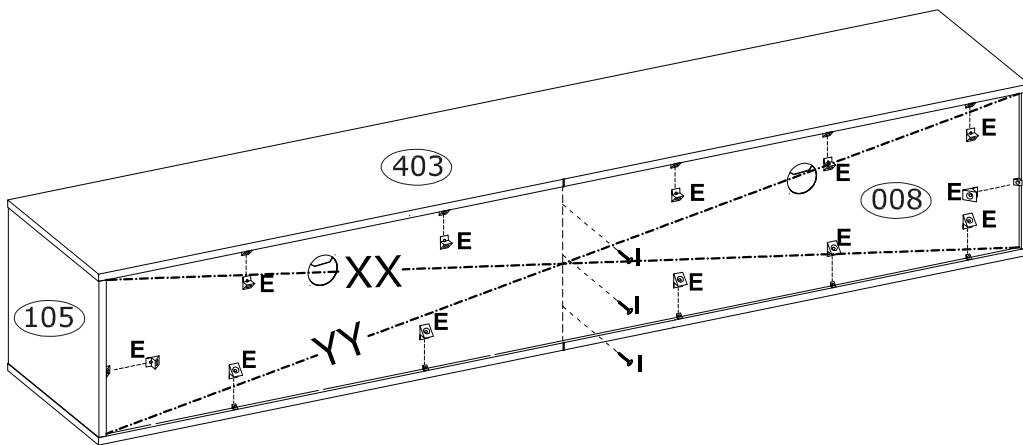
<p>E 15x14x11 mm</p>  <p>x12 4044</p>	<p>I $\varnothing 3,0 \times 20$ mm</p>  <p>x3 3886</p>	
---	--	---



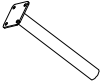

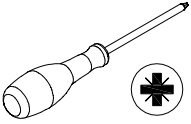
9

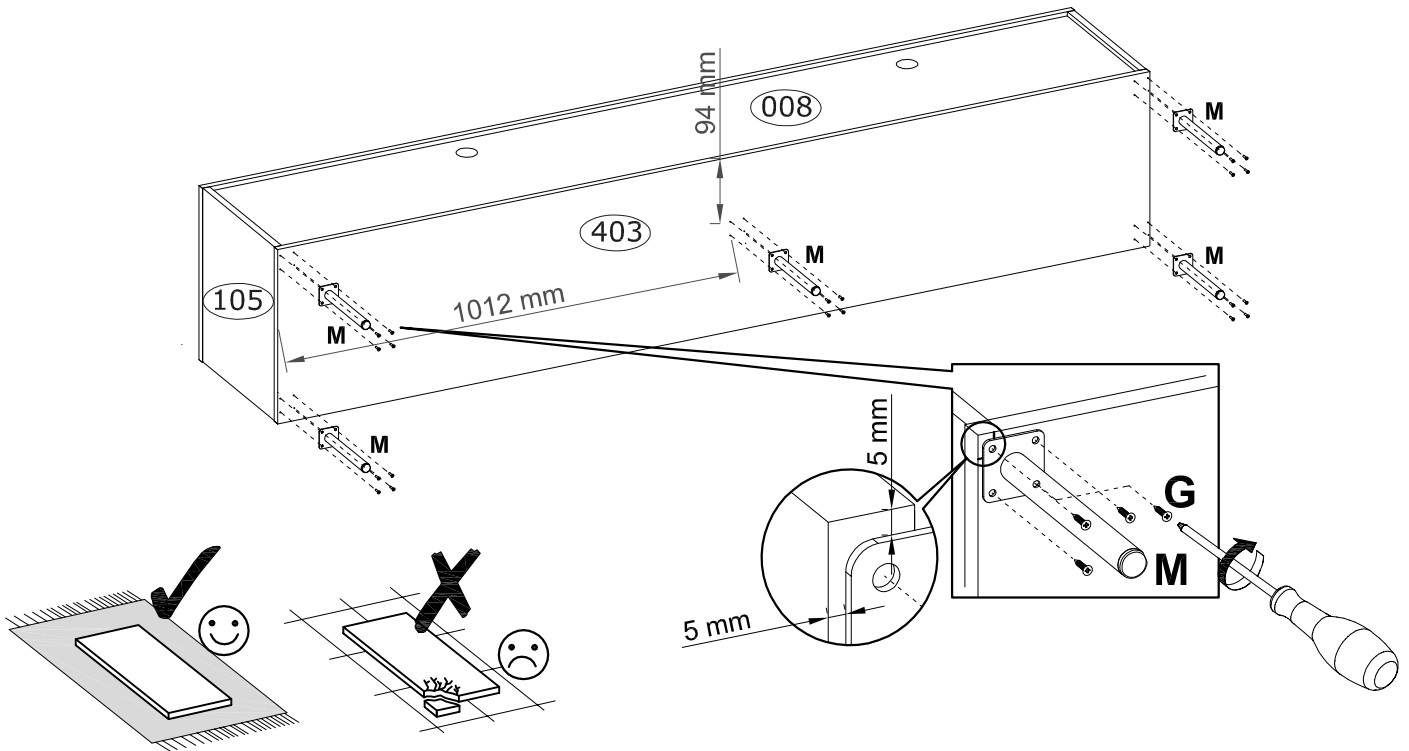
<p>M Ø20, H-180 x5 232943</p> 	<p>G Ø3,5x16 mm x20 3918</p> 	
--	---	--



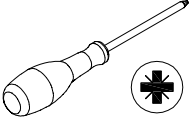

10

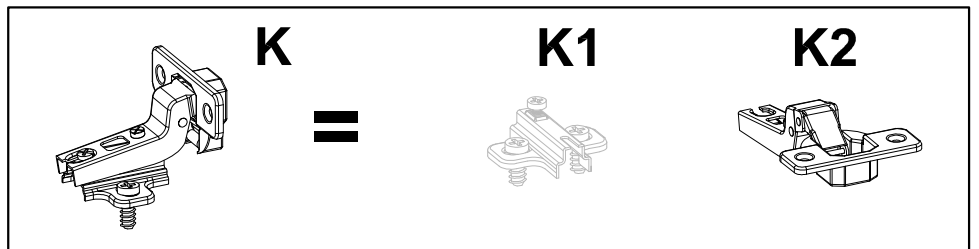
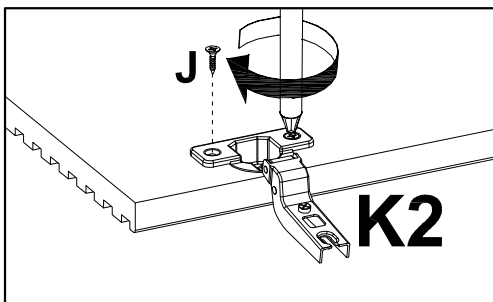
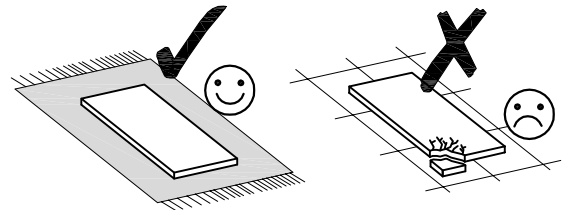
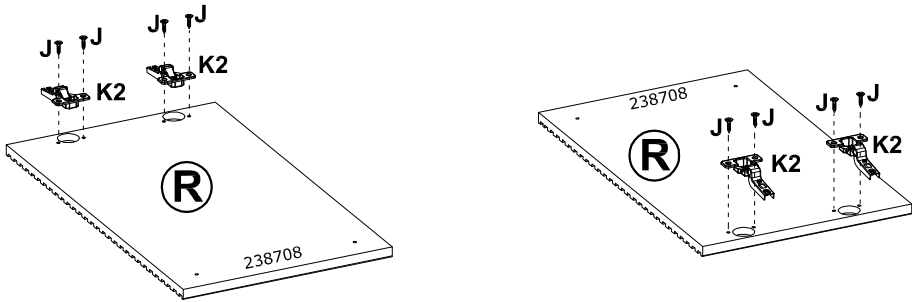
<p>K Ø35 mm, KR15 x4 68850</p> 	<p>J Ø3,0x13 mm x8 3912</p> 	
---	--	---

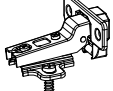

11

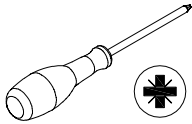
<p>L Ø35 mm , KR8</p>  <p>x4 67350</p>	<p>J Ø3,0x13 mm</p>  <p>x8 3912</p>	
---	--	--

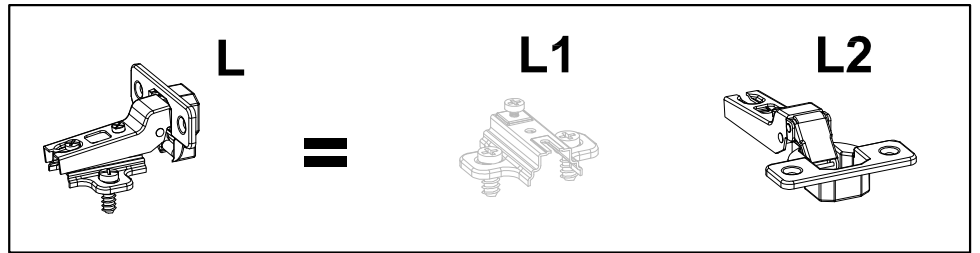
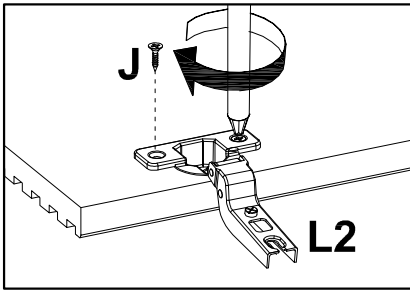
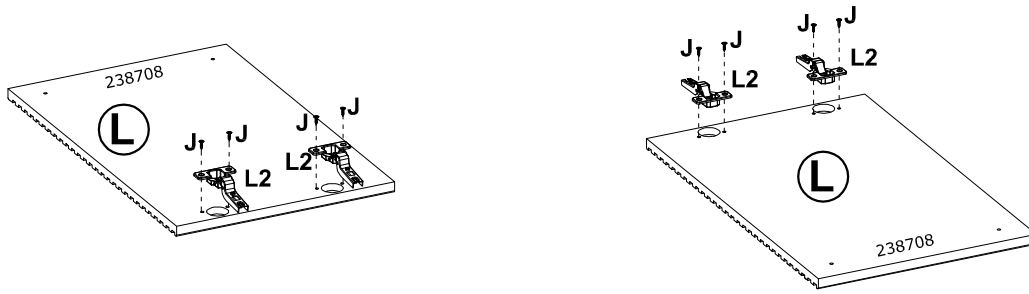

12

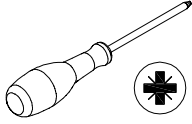
<p>N Ø26x10 mm</p>  <p>x4 237854</p>	
--	--

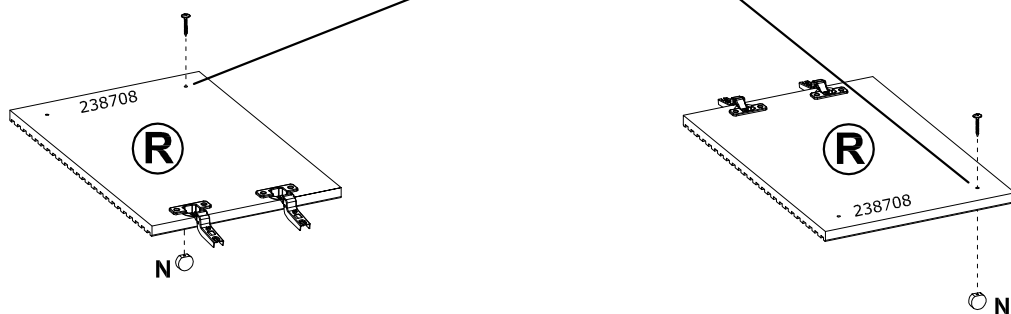
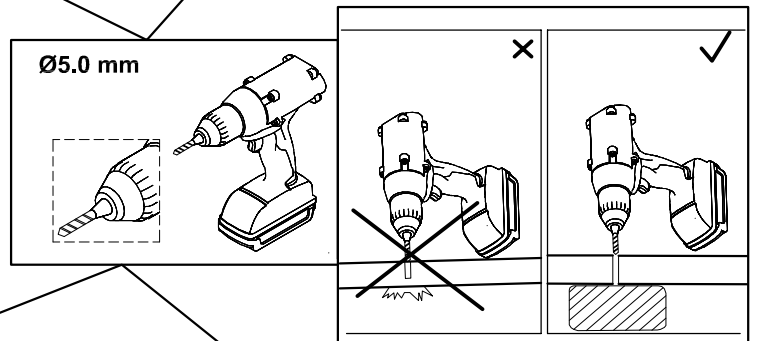
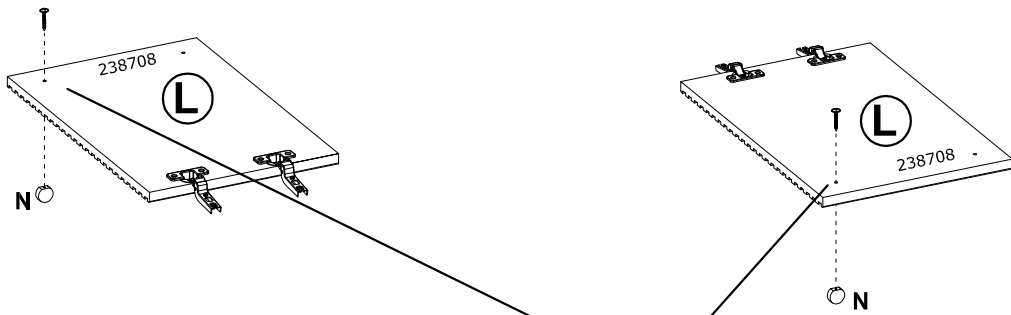

15

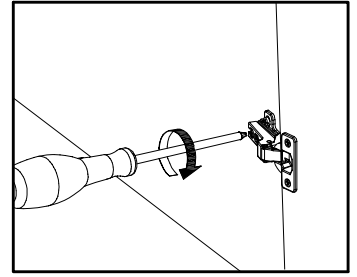
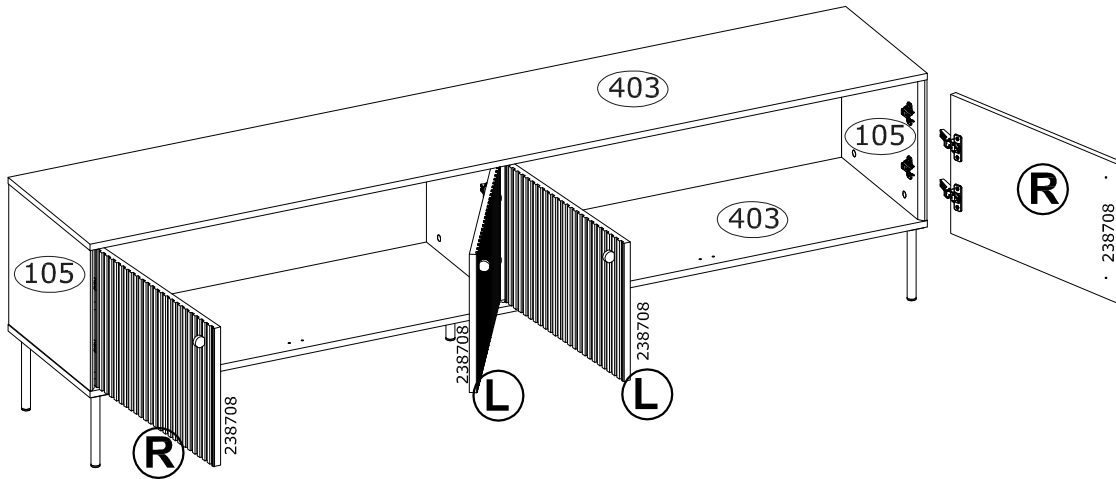
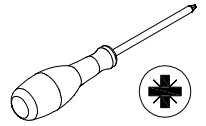

Türen einstellen (Scharniere justieren)
 Adjusting the door (adjusting the hinges)
Régler les portes (ajuster les charnières)
 Sistemare le porte (regolare le cerniere)
 Deuren instellen (scharnieren afstellen)
 Nastawić drzwi (wyregulować zawiasy)
 Vyrovnajte dvířka (seříd'te závěsy)
 Nastavenie dverí (nastavenie závesov)
 Állítsa be az ajtókat (állítsa be a zsanérokat)

Reglare uși (ajustare balamale)
Kapilarin ayarlanması (menteşelerin seviye ayarı)
 Регулировка дверей (регулировка шарнира)
 Поставите врата (подесите шарке)
 Postavite vrata (podesite šarke)
 Nastavenie dverí (nastavenie závesov)
 Sureguliuokite duris (sureguliuokite vyrius)
Pielāgojiet durvis (noregulējiet eņģes)
 Reguleeri uks (reguleeri hinged)

