

R 19

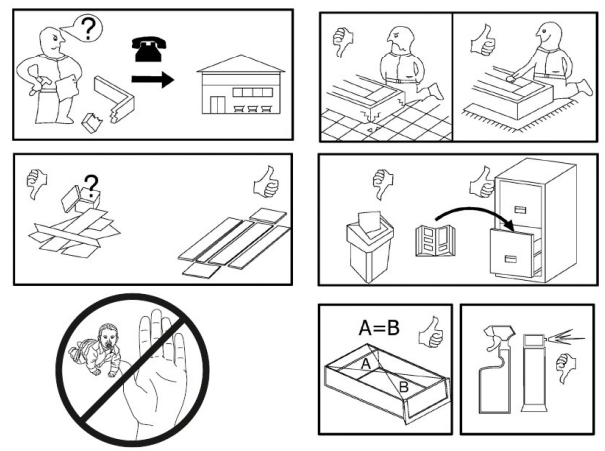
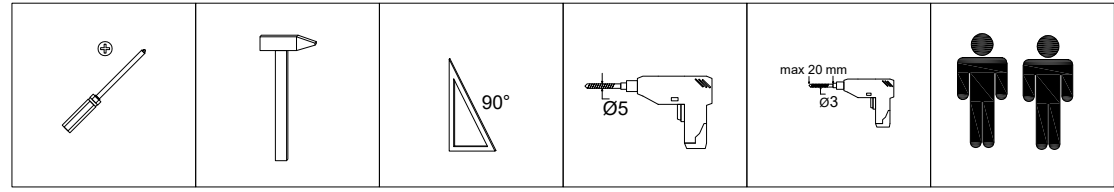
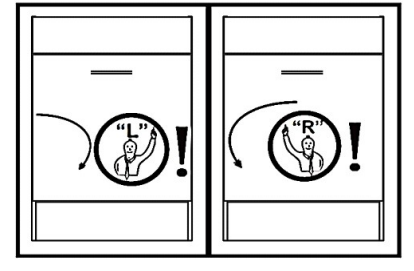

A	x6	B	x5	B1	x4	B3	x4
8x40		8x6x13		8x6x40		15x13	

C2	x22	F	x30	G	x2	H	x5	J1	x1
3,5x16mm									

M1	x4	O3	x8	O9	x1	O11	x8	L	x3
Ø35mm		Ø13mm		4mm		7x50			

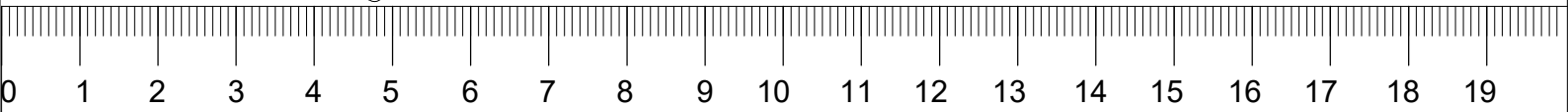
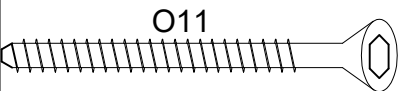



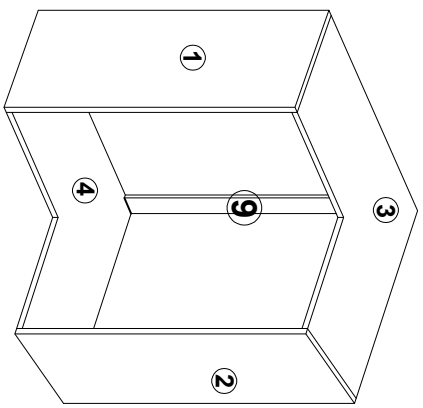

I

6\_RII 19

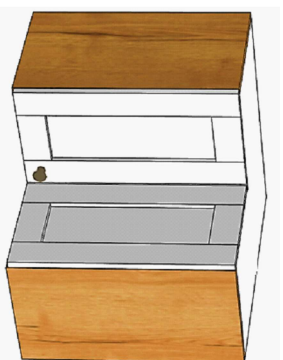
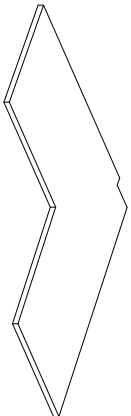

II

