

NOTICE DE MONTAGE
 ASSEMBLING INSTRUCTIONS
 ISTRUZIONI DI MONTAGGIO
 MONTAGEANTEILUNG
 INSTRUCOES DE MONTAGEM
 MANUAL DE MONTAJE
 SASTAVLJANJE UPUTE
 INSTRUKCJA MONTAŻU

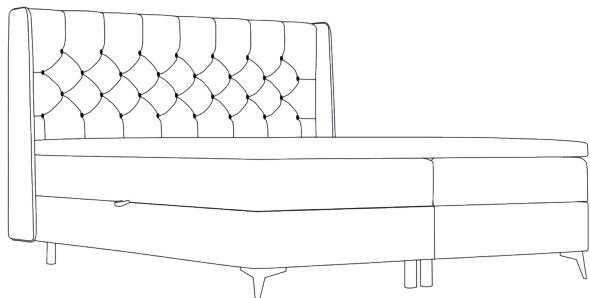



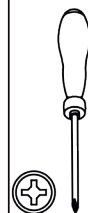

ZARA 140 160 180

2024/05/31



30 MIN

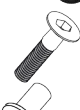

A 13cm  x2	B Ø3,5x25  x8	C 13cm  x6	D Ø8x70mm  x4	E Ø8cm  x4	F Ø8cm  x4	G  x1
-------------------------------------------------------------------------------------------------------------	----------------------------------------------------------------------------------------------------------------	-------------------------------------------------------------------------------------------------------------	-----------------------------------------------------------------------------------------------------------------	---------------------------------------------------------------------------------------------------------------	---------------------------------------------------------------------------------------------------------------	-------------------------------------------------------------------------------------------------------

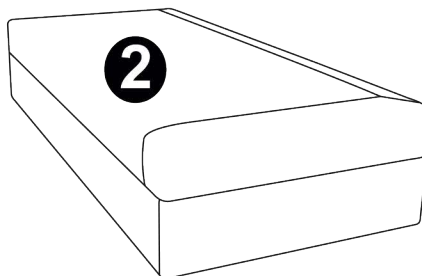
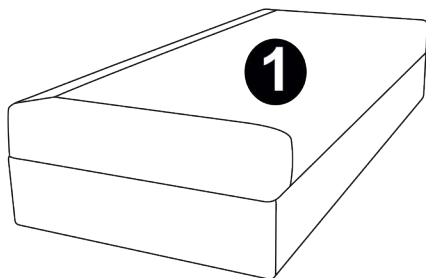
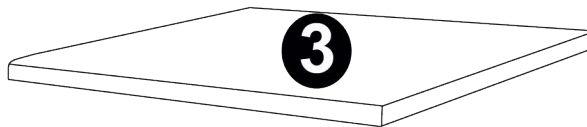
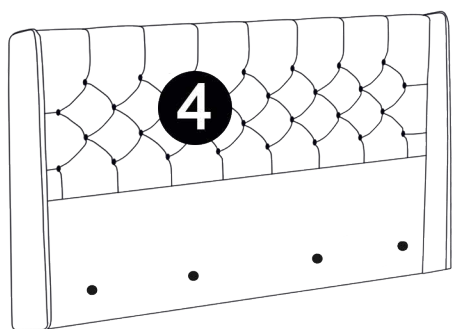

AVANT DE COMMENCER, SE
 REPORTER AUX CONSEILS
 DE MONTAGE EN ANNEXE

BEFORE STARTING REFER
 TO THE ASSEMBLING ADVICE
 IN ANNEX

AVANTI DI COMMINCIARE
 RIPORTATE AGLI CONSIGLI DI
 MONTAGGIO

VOR DIE MONTAGE, BITTE
 BEILIEGENDE ANWEISUNGEN
 FOLGEN

ANTES DE COMERCAR, ADIARSE
 AOS CONSELHOS DE
 MONTAGEM EM ANEXO

ANTES DE EMPEZAR
 CONSULTE LOS CONSEJOS
 PARA EL MONTAJE

PRJE POČETKA OBRATITE
 U okupljanje savjet u DODA TKU

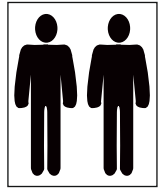
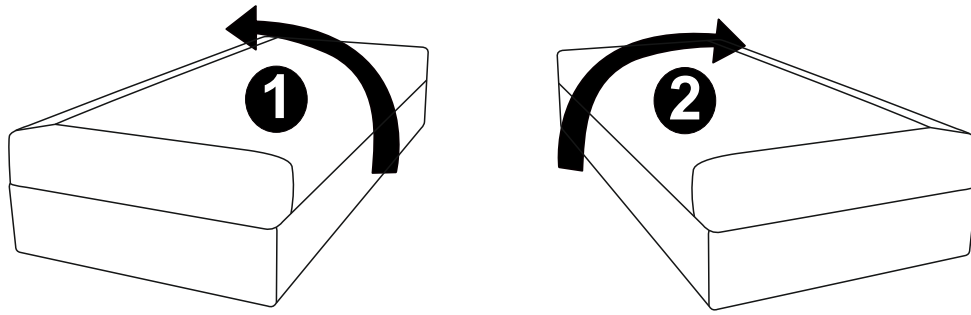

PROSZĘ ZAPOZNAĆ SIĘ Z INSTRUKCJĄ
 PRZED ROZPOCZĘCIEM MONTAŻU

I

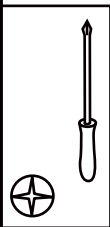
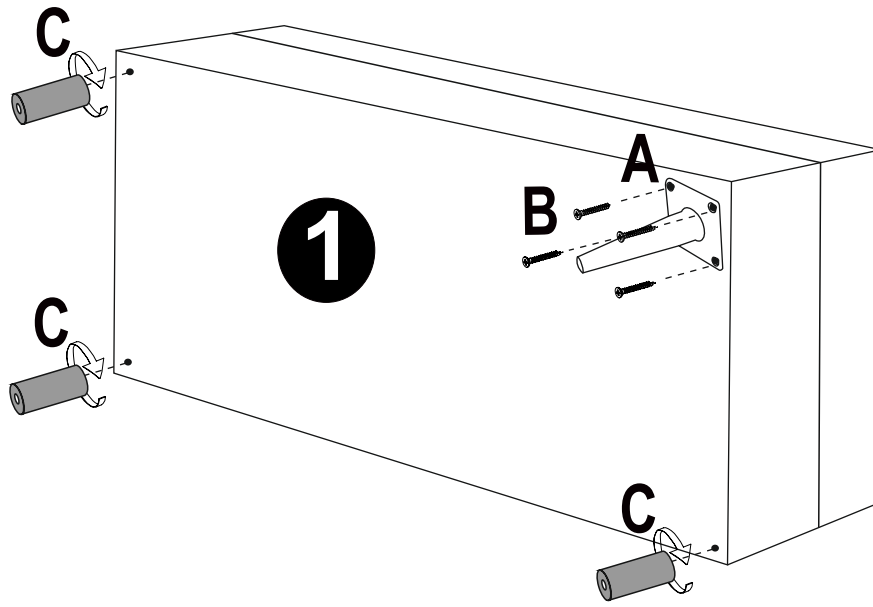

II

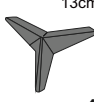

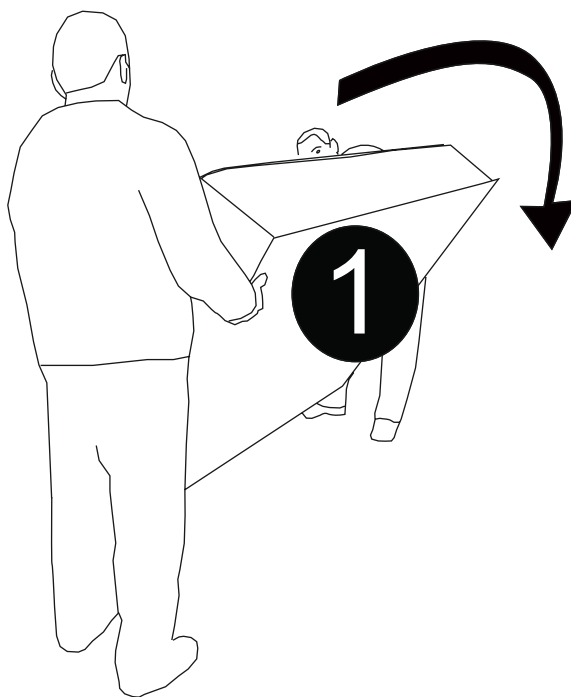

A 13cm  x1	B Ø3,5x25  x4	C 13cm  x3
-----------------------------------------------------------------------------------------------------------------	--------------------------------------------------------------------------------------------------------------------	-----------------------------------------------------------------------------------------------------------------

III

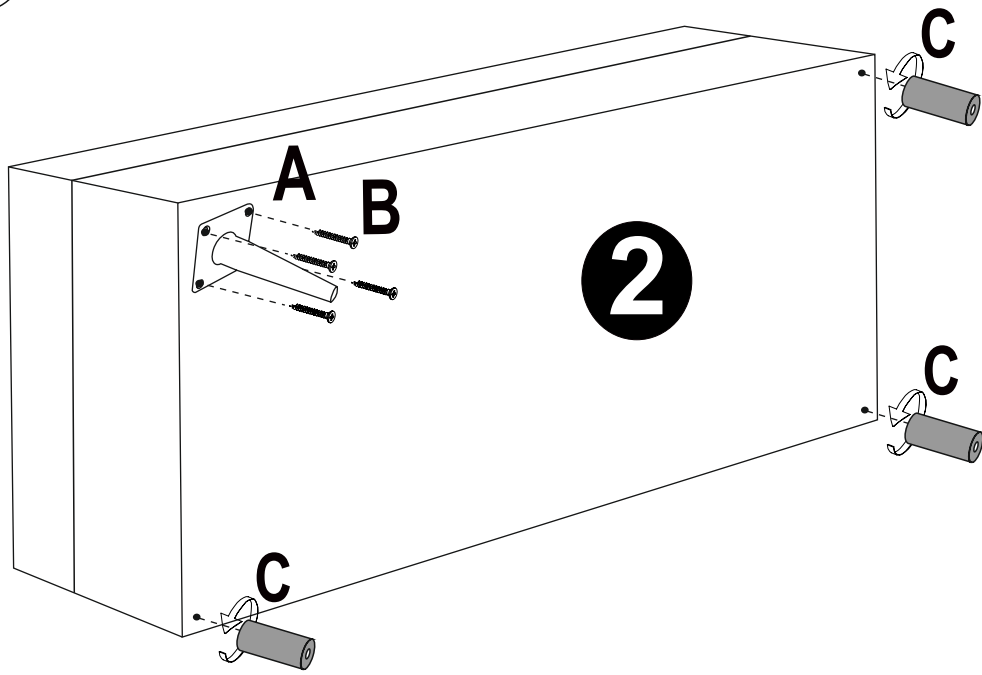

IV

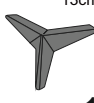

A 13cm  x1	B Ø3.5x25  x4	C 13cm  x3
-----------------------------------------------------------------------------------------------------------------	--------------------------------------------------------------------------------------------------------------------	-----------------------------------------------------------------------------------------------------------------

V

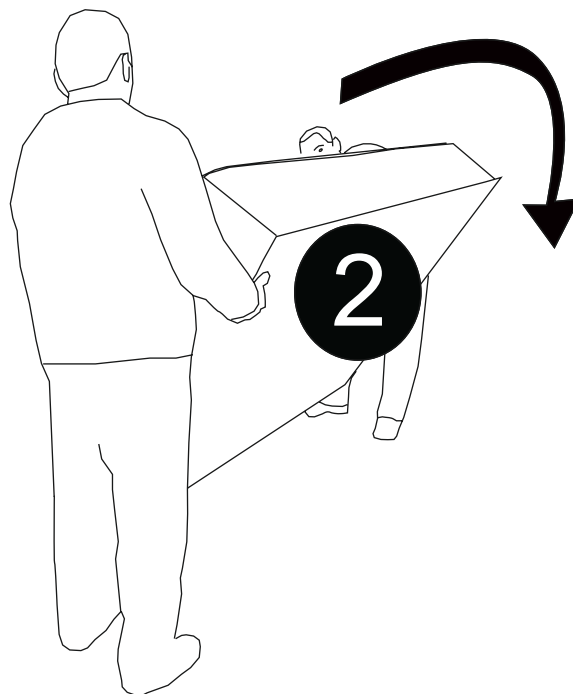



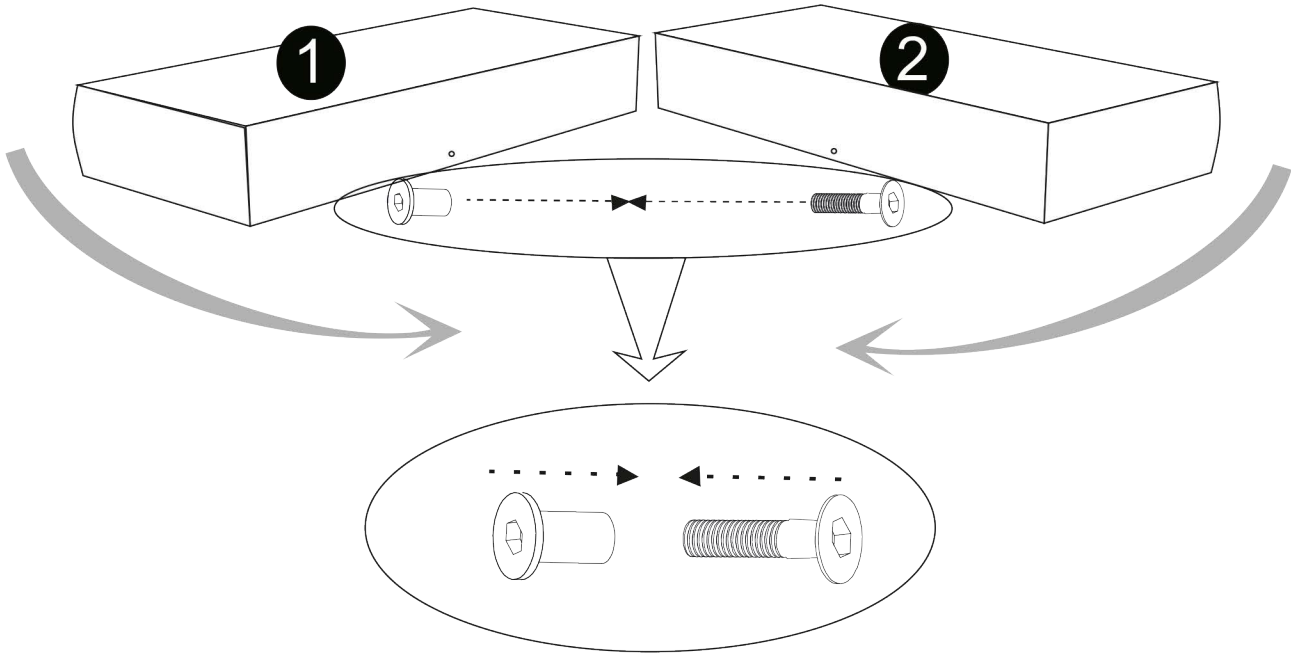

VI

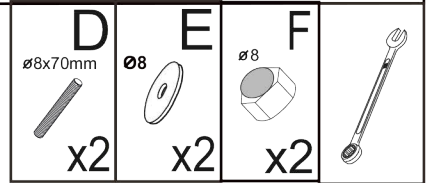
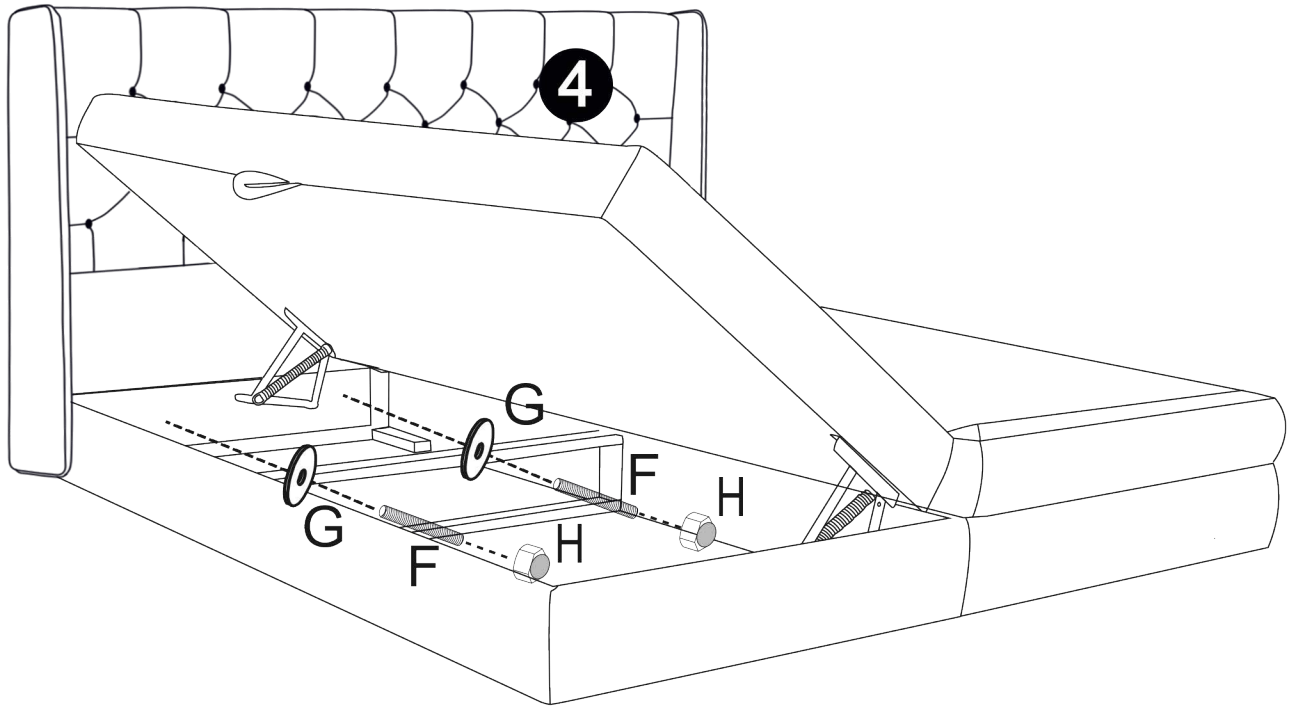

VII



VIII

D ø8x70mm  x2	E ø8  x2	F ø8  x2	
-----------------------------------------------------------------------------------------------------------------	------------------------------------------------------------------------------------------------------------	------------------------------------------------------------------------------------------------------------	------------------------------------------------------------------------------------

