

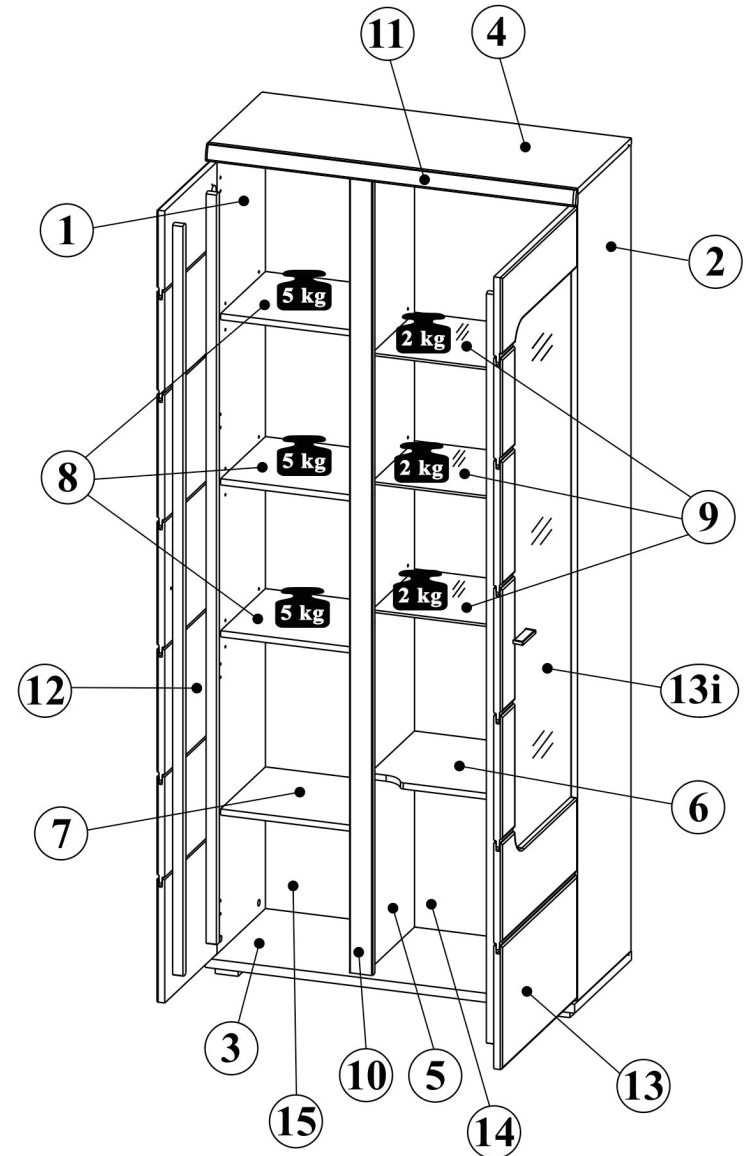

B - 901mm
 H - 2022mm
 T - 380mm

1	1962	358	1	2
2	1962	358	1	2
3	900	380	1	1
4	900	358	1	1
5	1962	322	1	2
6	504	355	1	1
7	346	300	1	1
8	345	300	3	1
9	503	290	3	1
10	1962	55	1	3
11	902	40	1	1
12	1932	350	1	3
13	1932	506	1	3
13i	1348	442	1	3
14	1973	515	1	3
15	1973	359	1	2

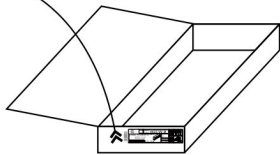



NR 1

B1  ϕ 8x30 x26

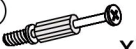
M1  ϕ 15x12mm x27

T1  x27

W1  x12

W13  12

NR 2

J23  x22

F1  x7

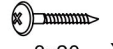
P2  3x20 x11

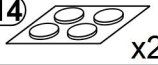
C14  x27

C15  x6

NR 3

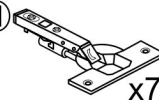
X11  x7

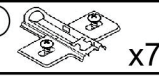
PH  x7

S8  3,5x13 x14

NR 4

N20  x5

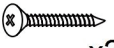
S2  4x30 x20

NR 5

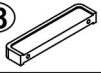
U188  x2

A2  M4x25 x2

A4  M4x12 x2

G4  L-4,5 ϕ 7 x2

NR 6

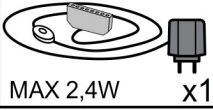
O21  MAX 2,4W x1

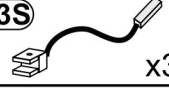
S3S  x3

LED-Beleuchtung:
Zeta S 3S

NR 7

J11  x1

P13  3,5x13 x2

T13  8x50 mm x1

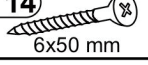
T14  6x50 mm x1

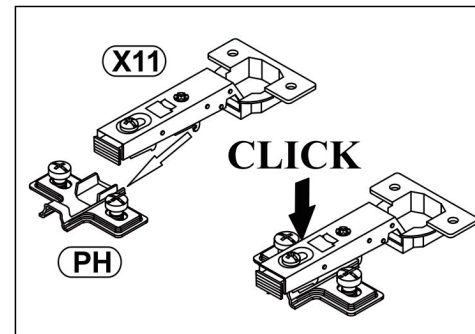
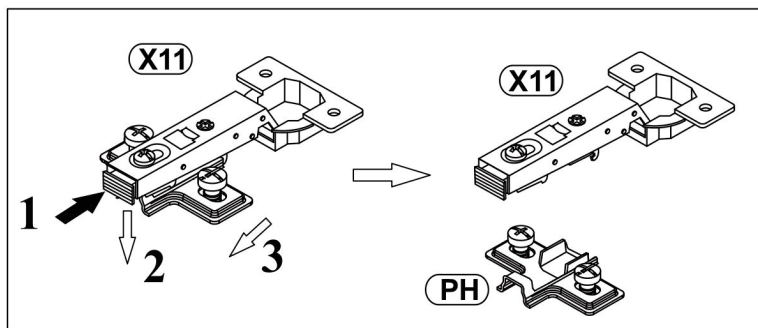

1

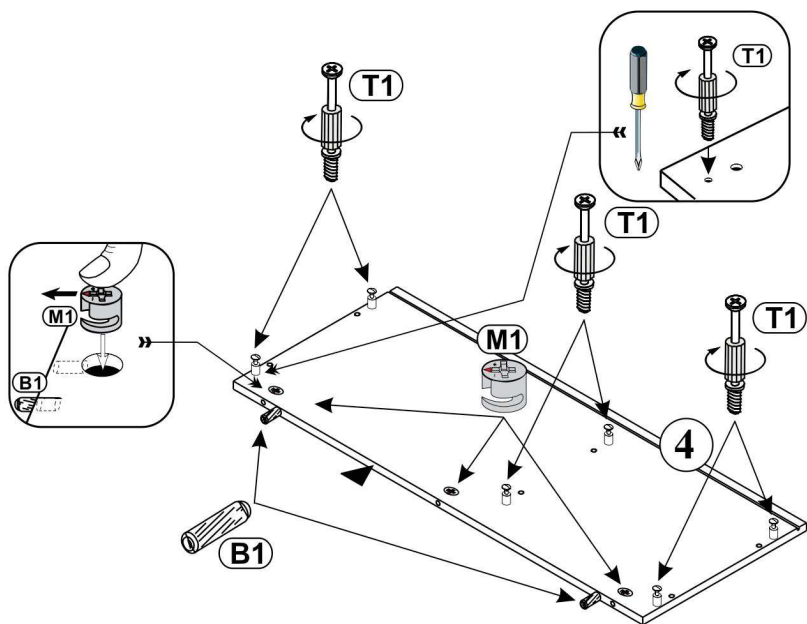
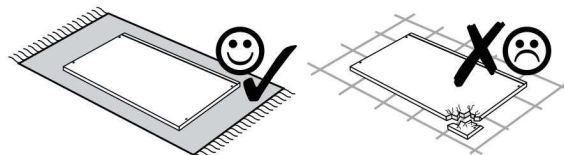
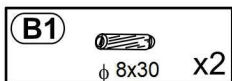
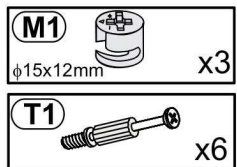

2

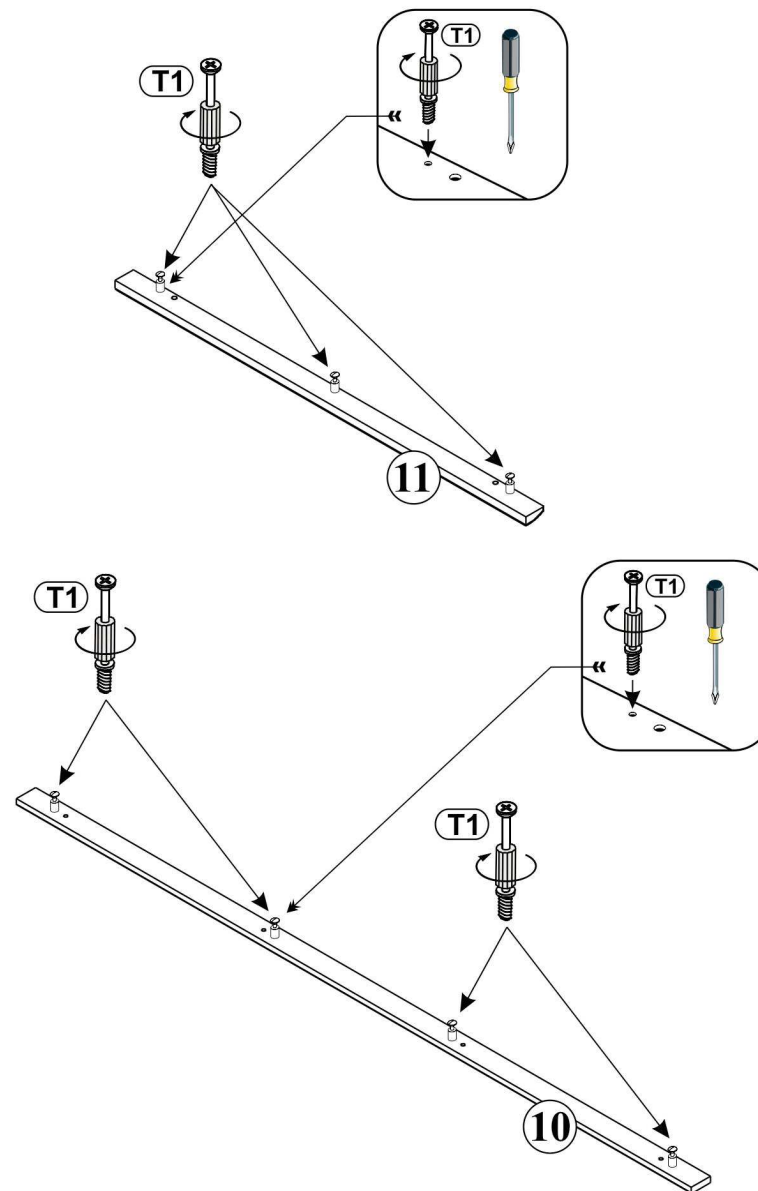
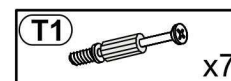

3

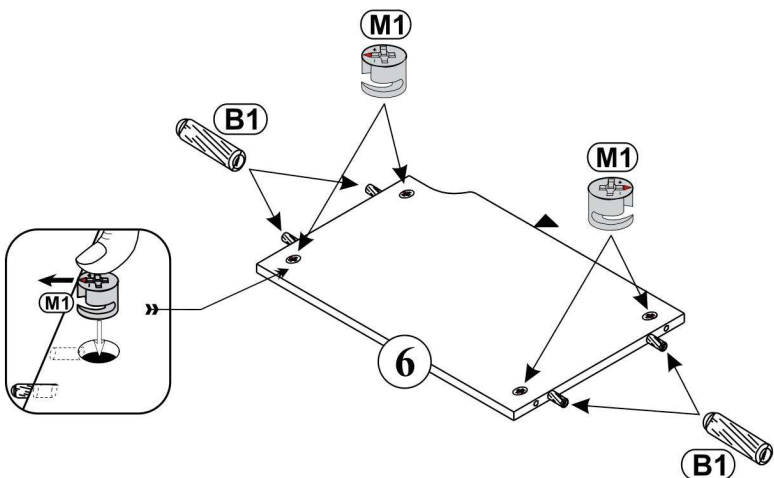
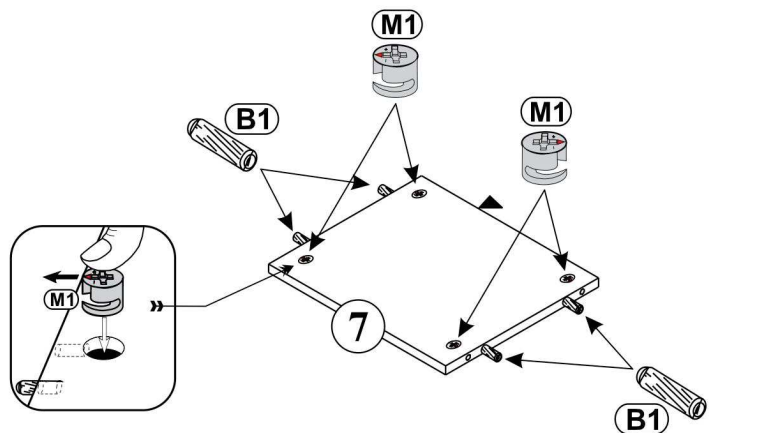
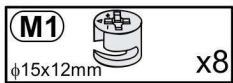
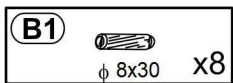

4

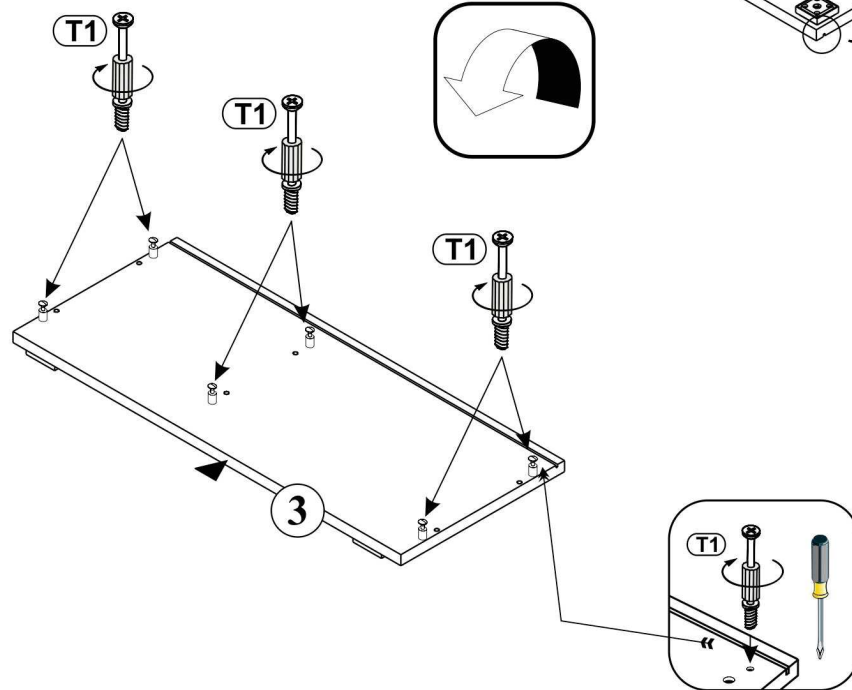
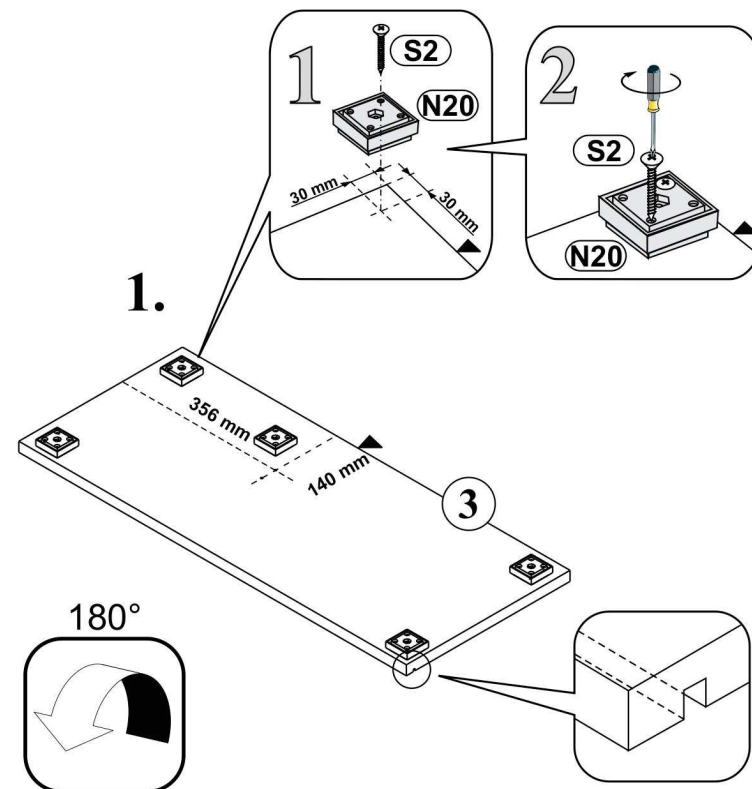
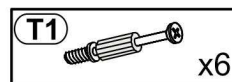
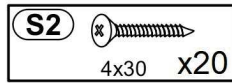
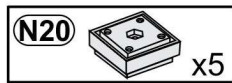

5

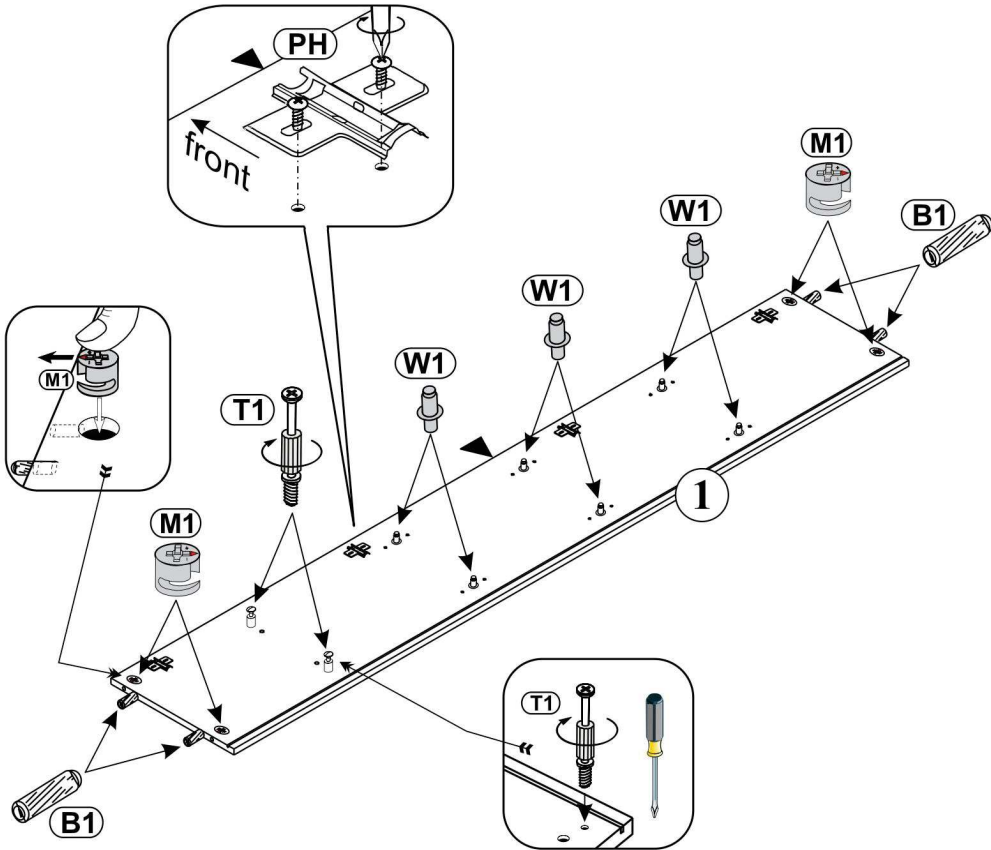
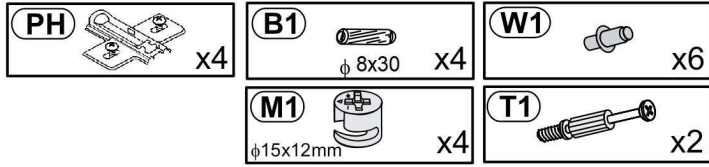

6

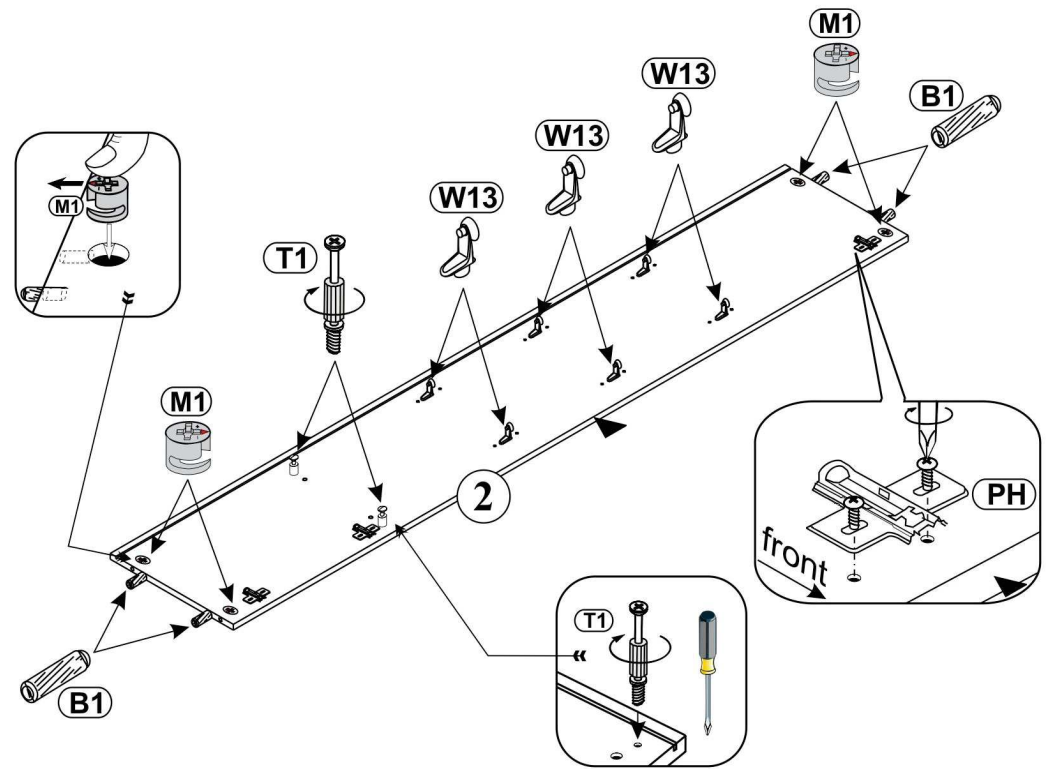
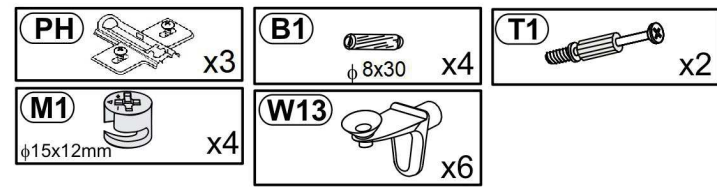

7

- | | | |
|--------------------------|-----------------|------------------|
| B1
φ 8x30 x8 | W1
x6 | W13
x6 |
| M1
φ15x12mm x8 | T1
x4 | |

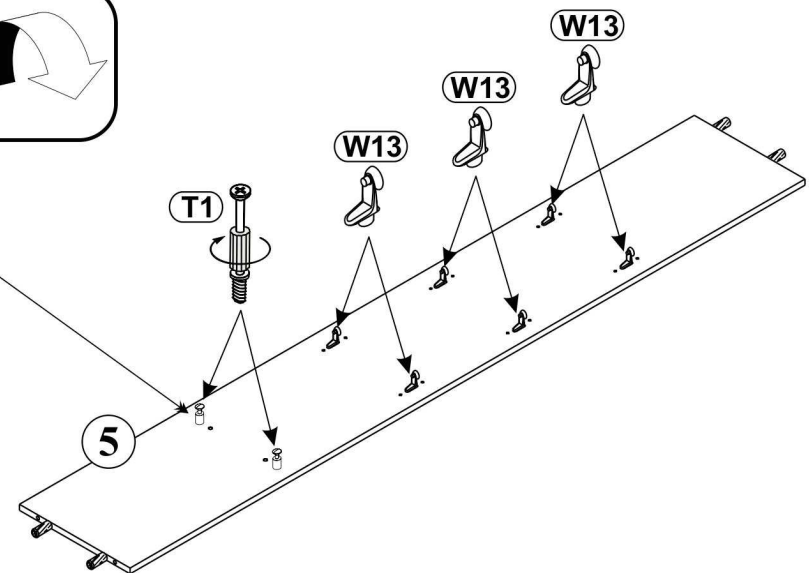
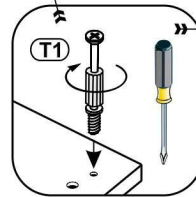
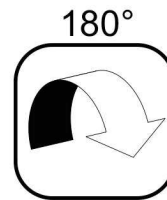
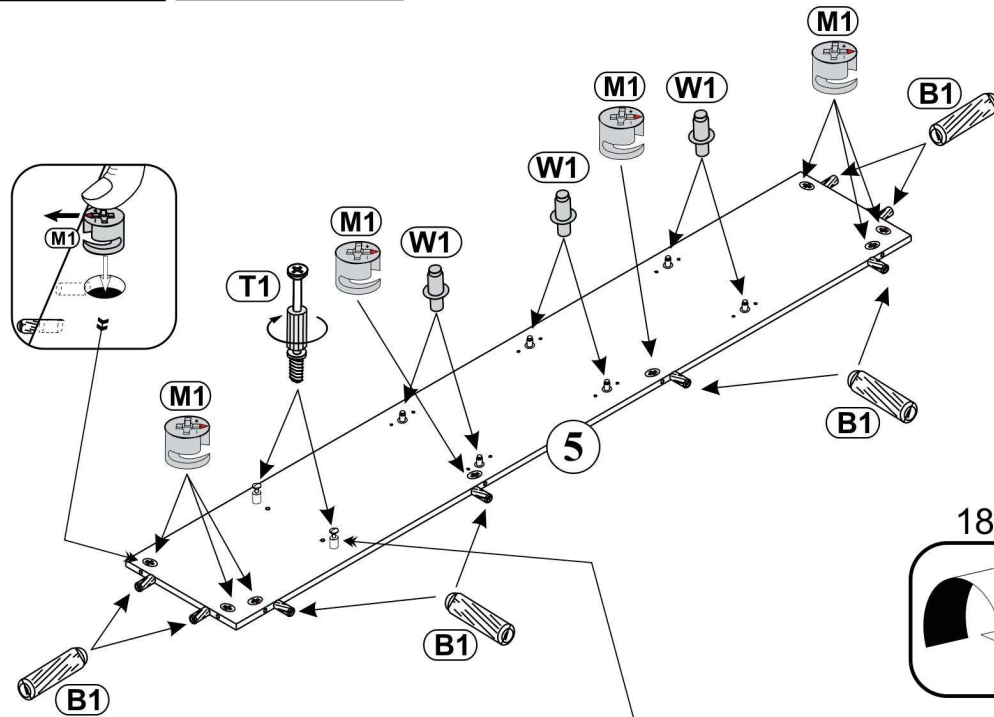
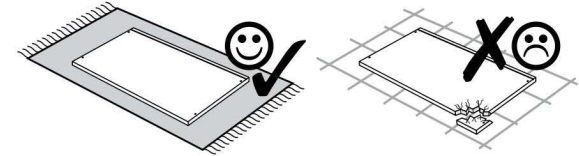

8

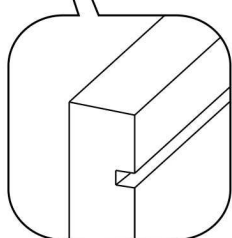
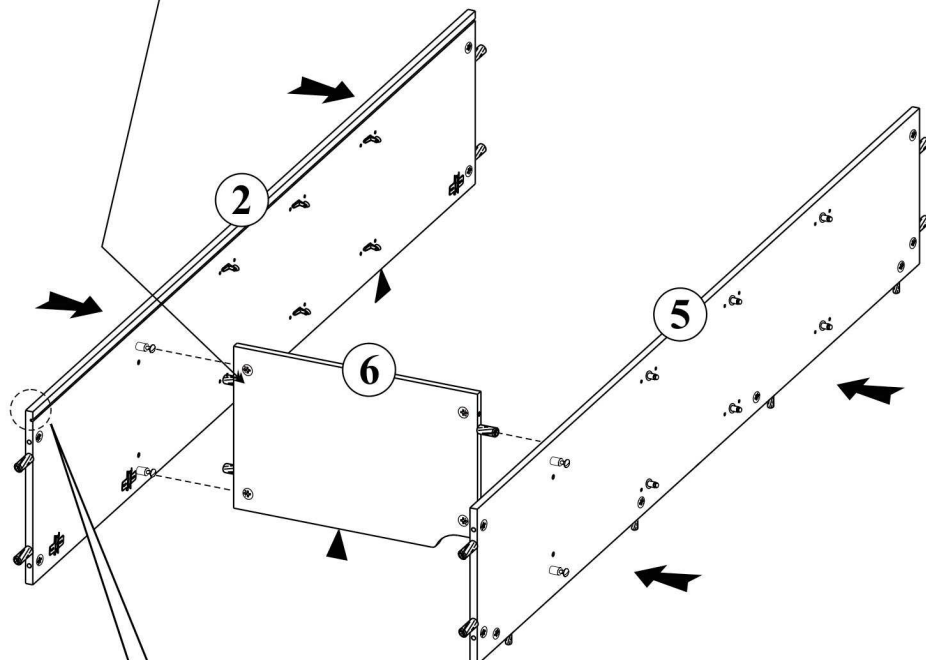
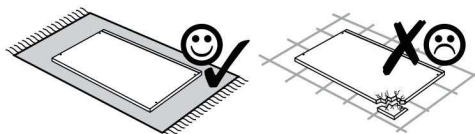
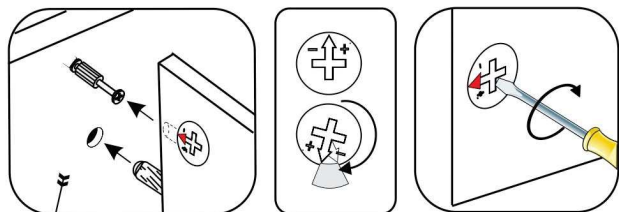

9

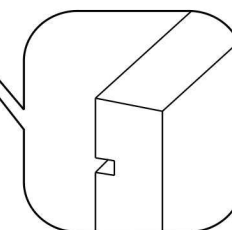
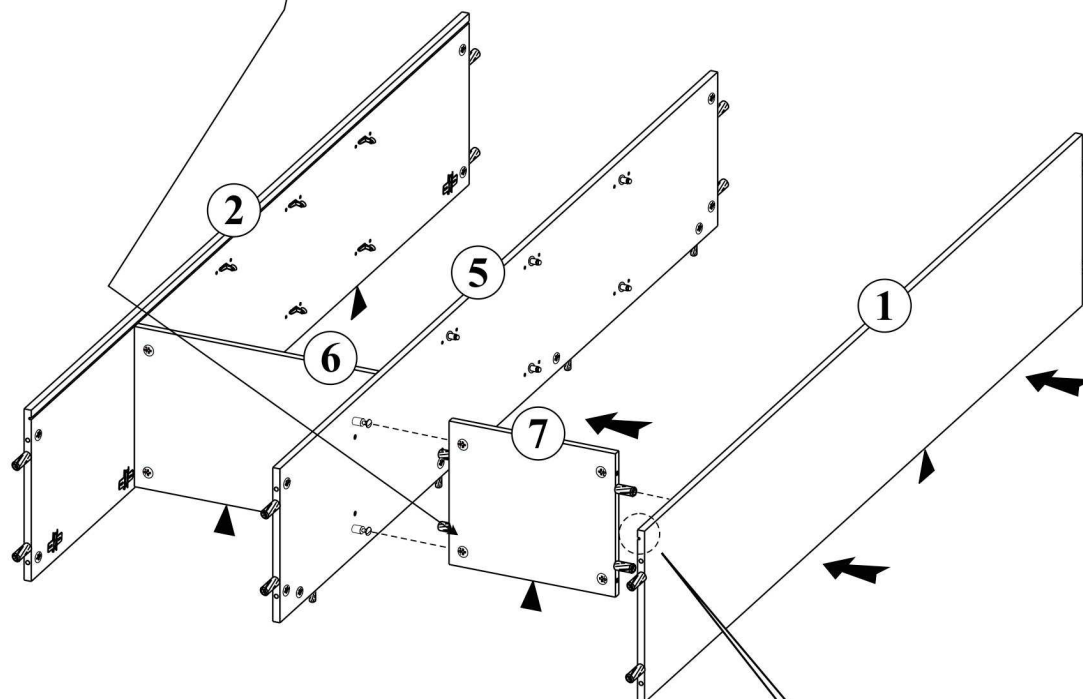
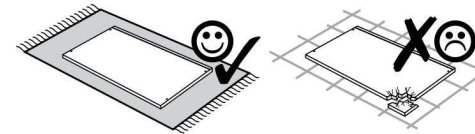
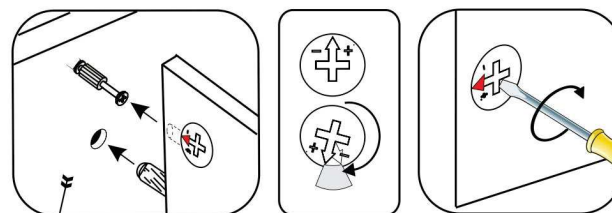

10

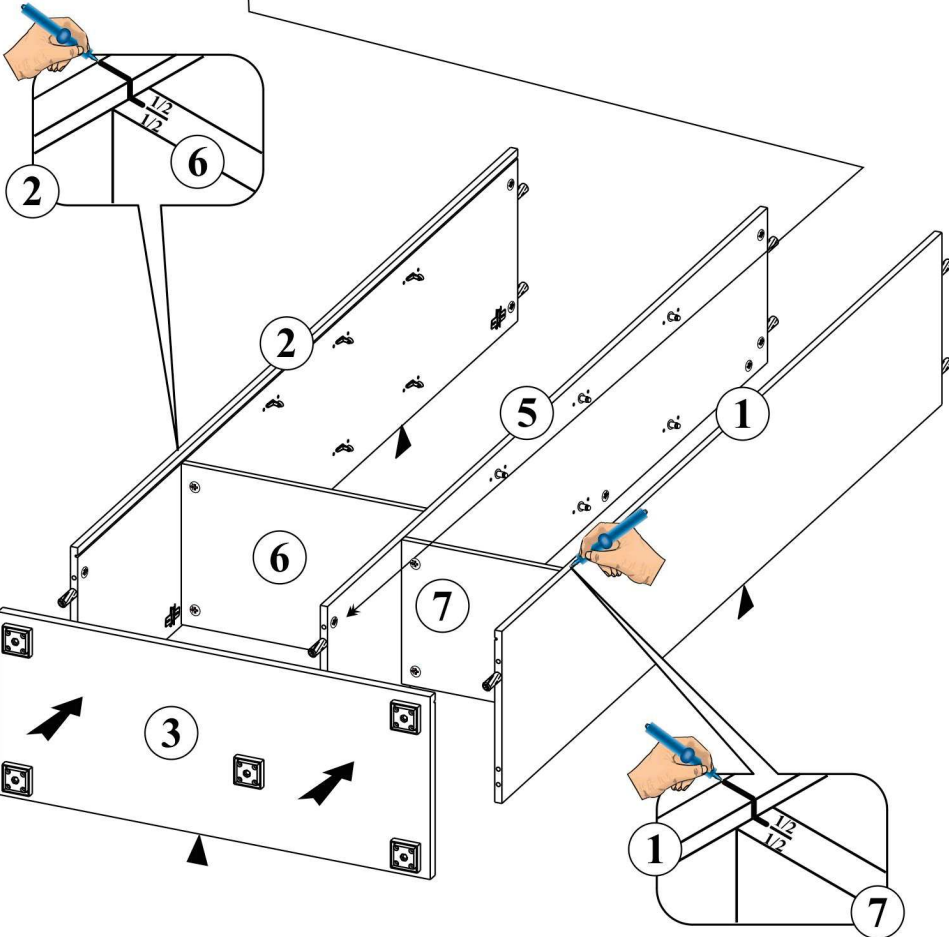
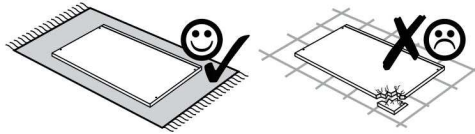
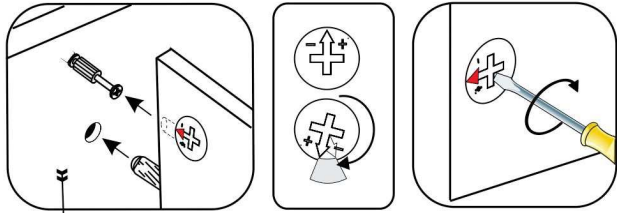

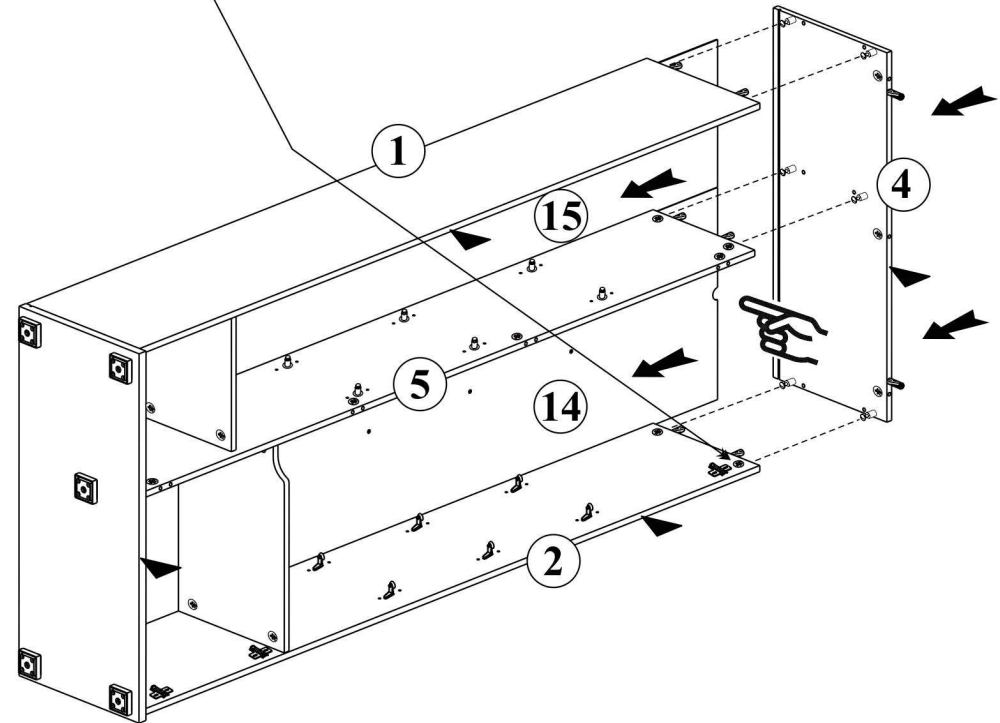
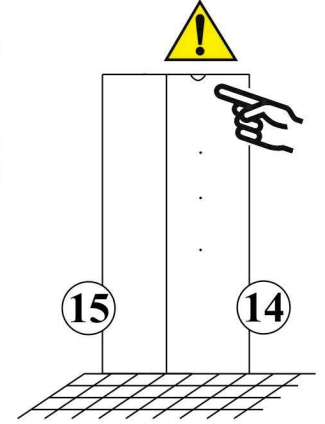
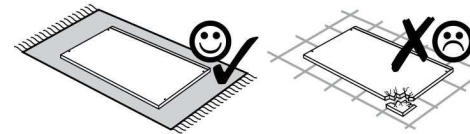
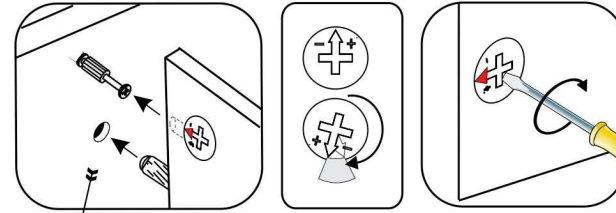

11

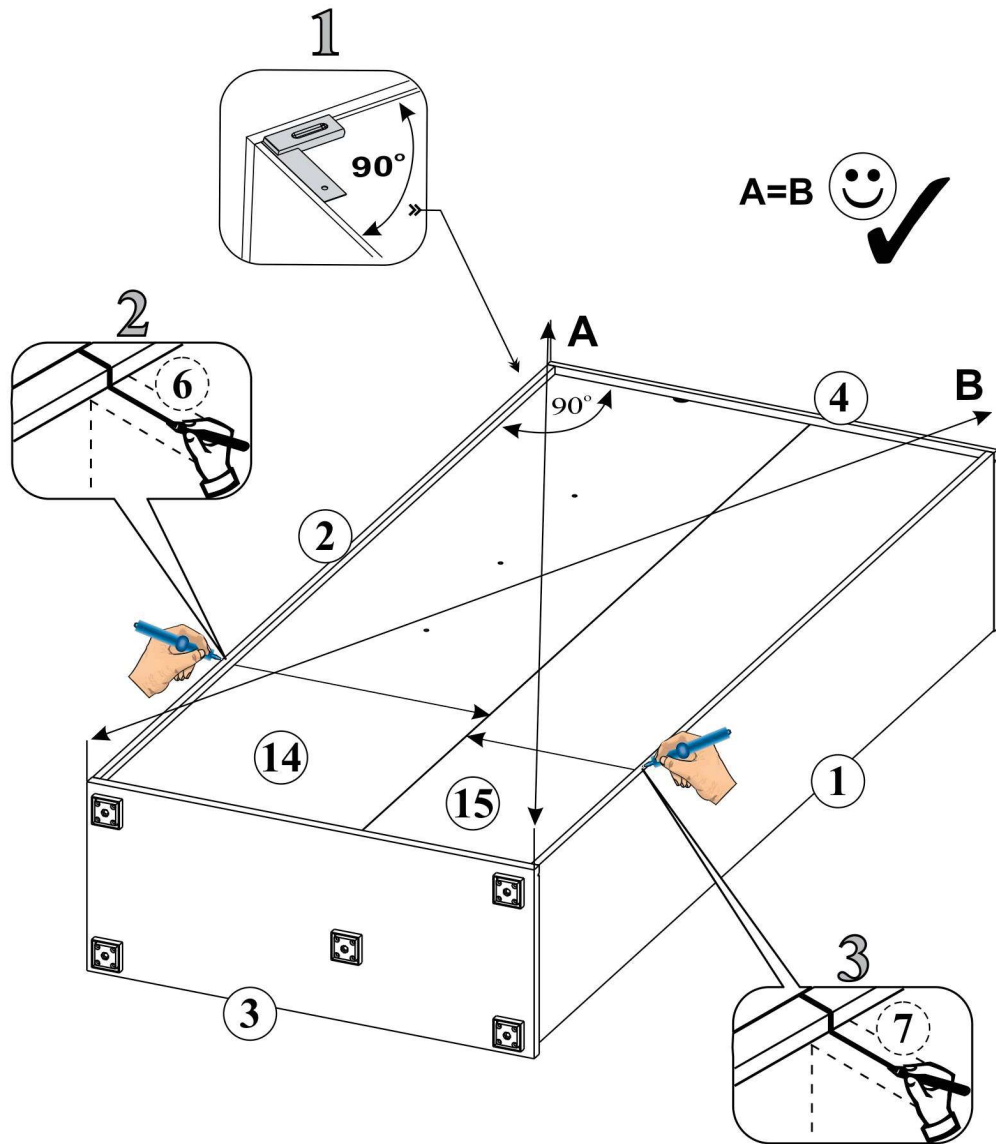

12



13

- J23**  x22
- F1**  x7
- P2**  3x20 x11

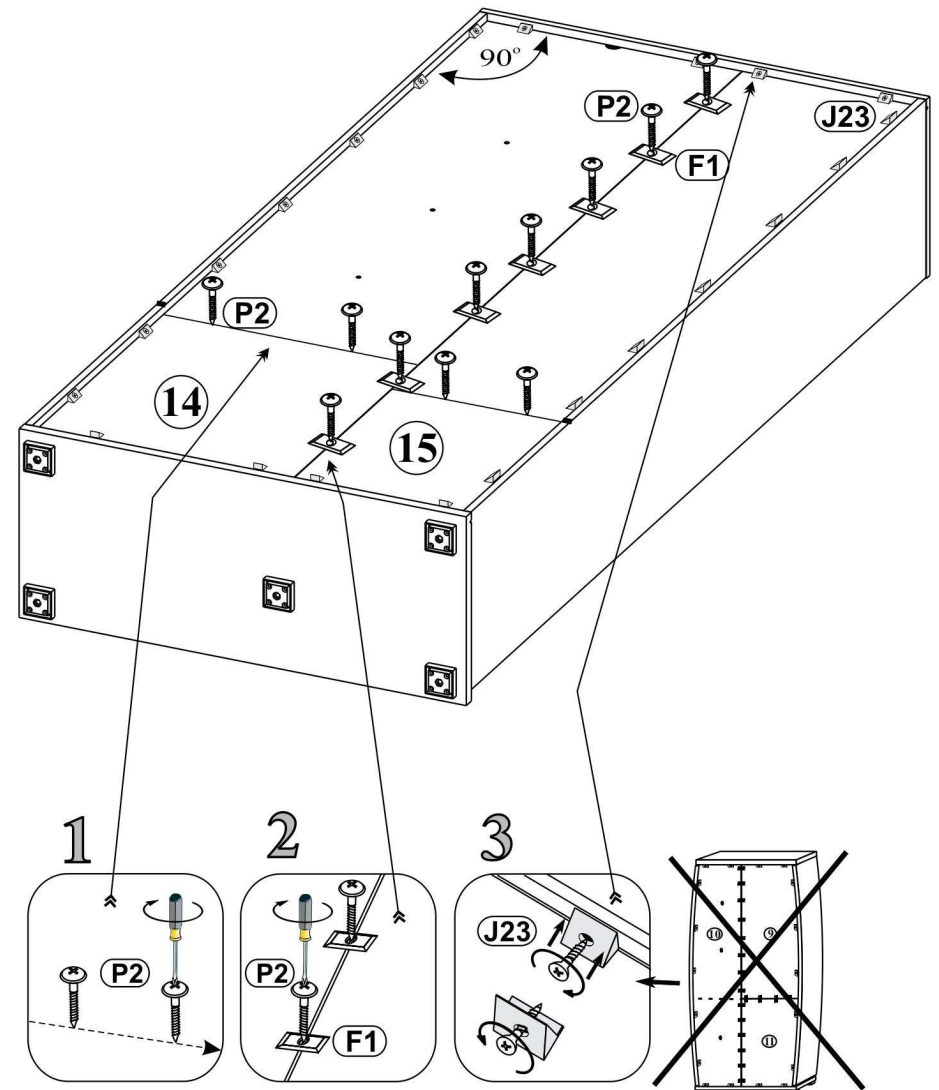

14

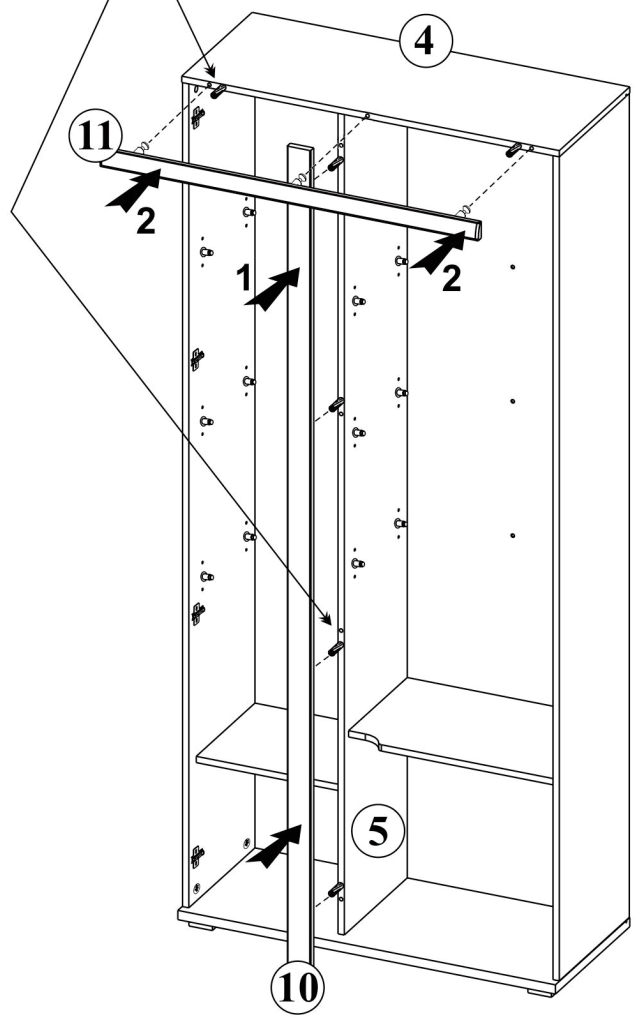
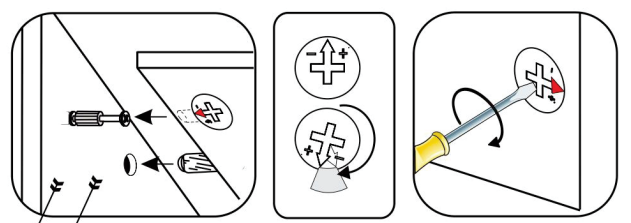

15

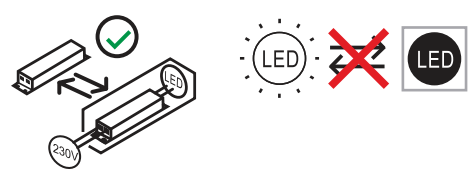
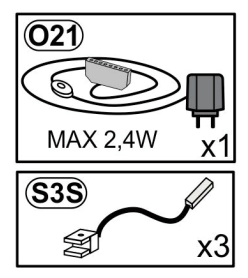

LED-osv. tlení/osvetlenie
Zeta S 3S

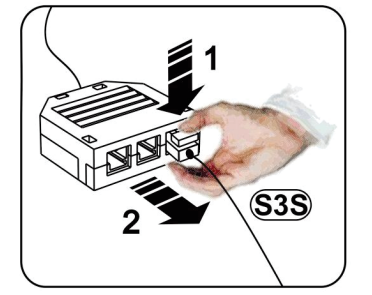
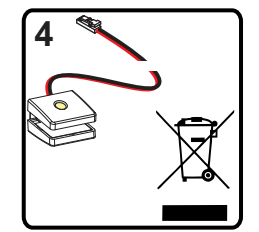
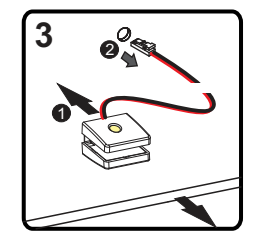
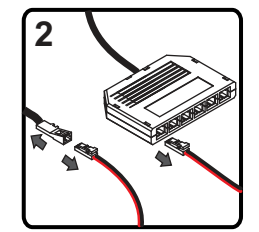
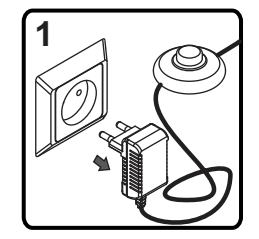
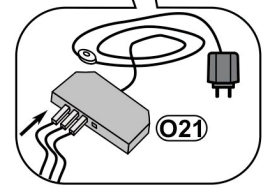
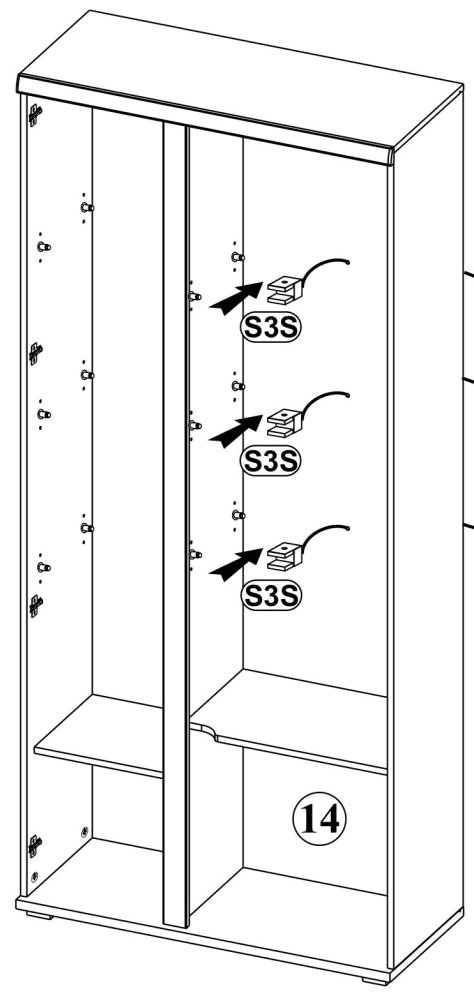

16

- J11  x1
- P13  3,5x13 x2
- T13  8x50 mm x1
- T14  6x50 mm x1

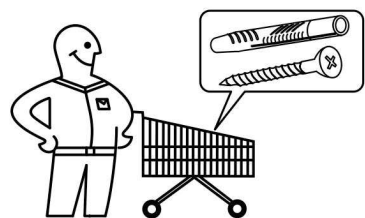
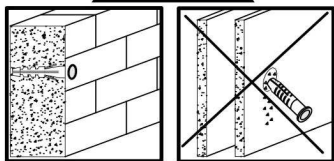
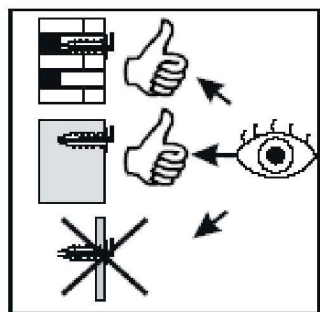

17

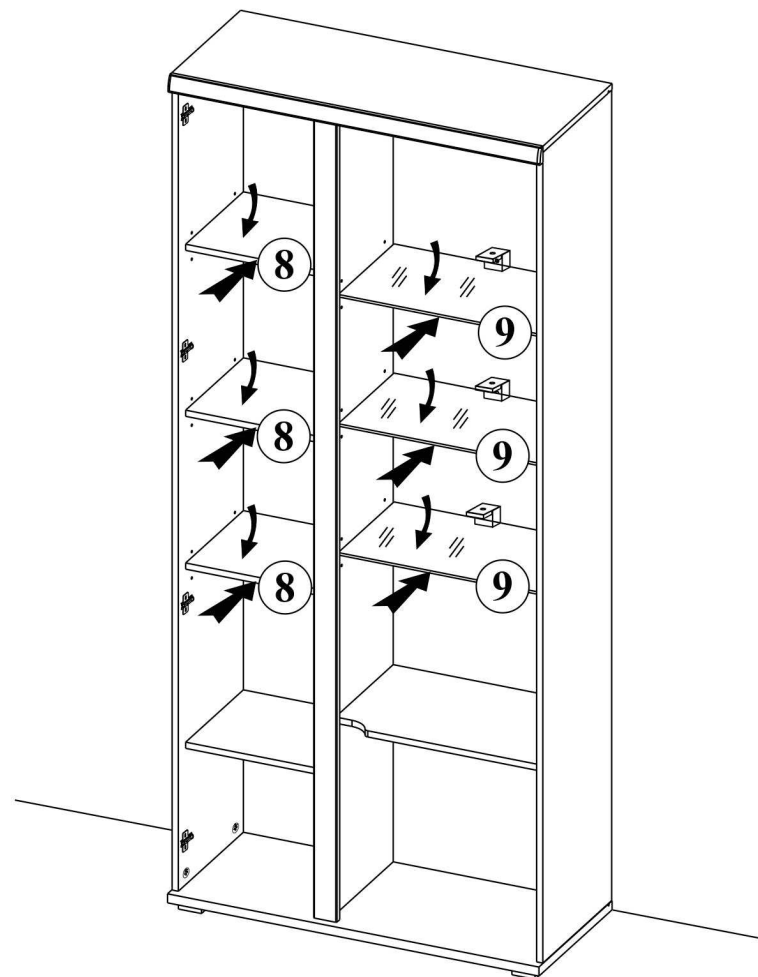

18

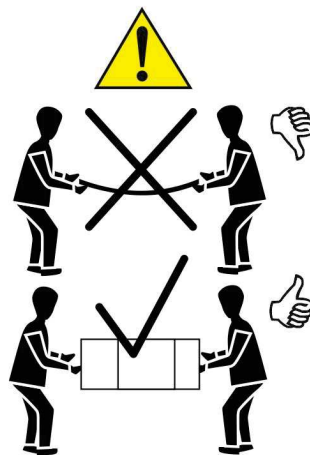
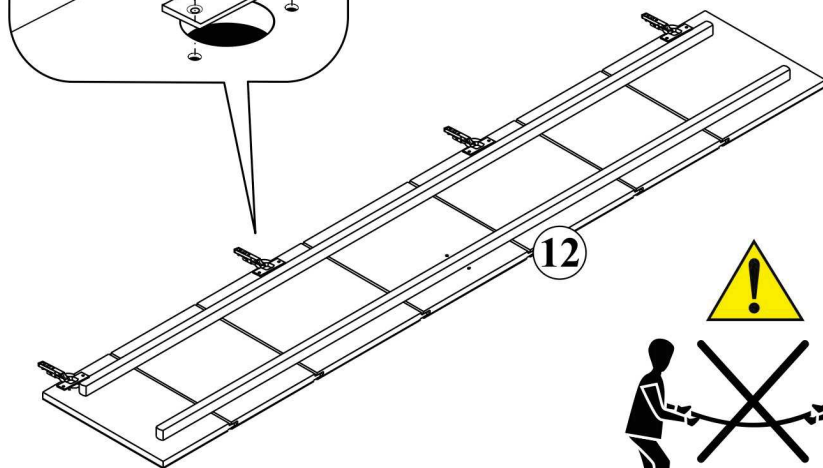
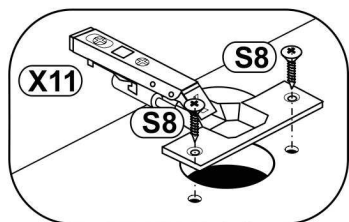
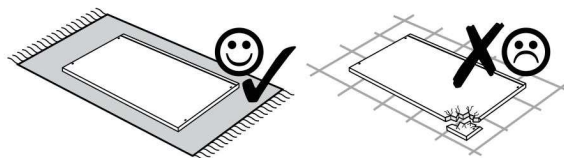
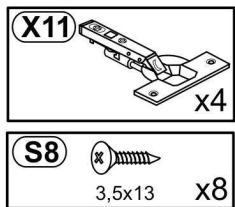



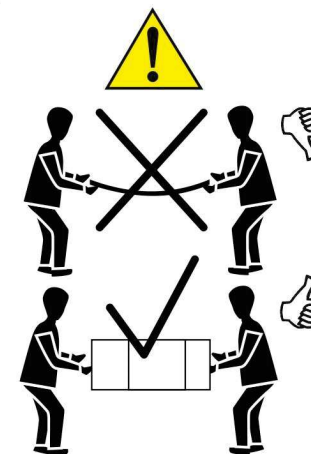
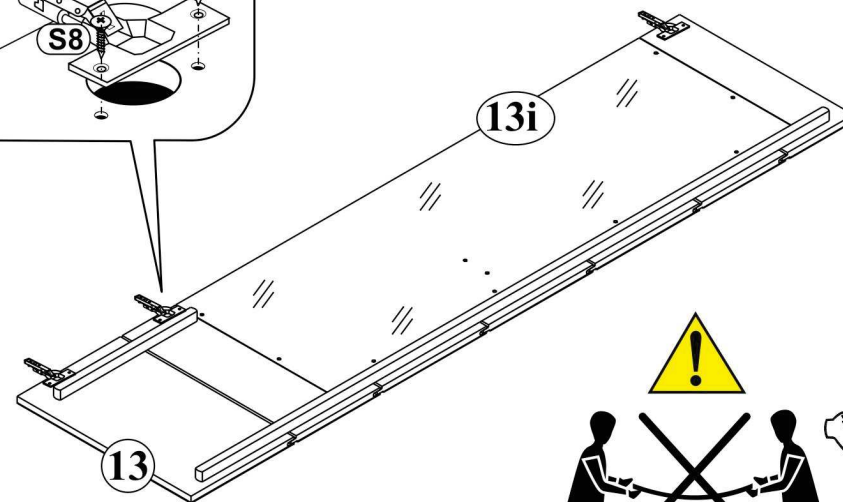
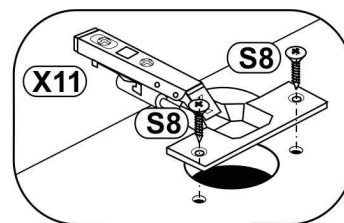
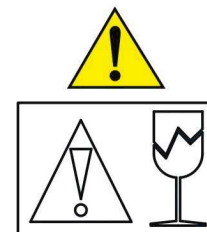
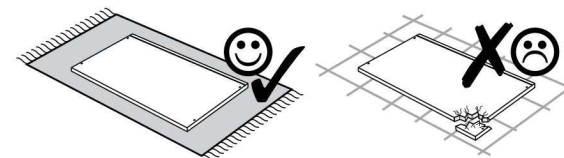
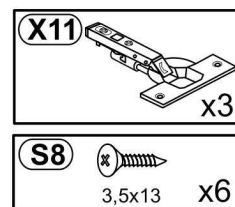

19

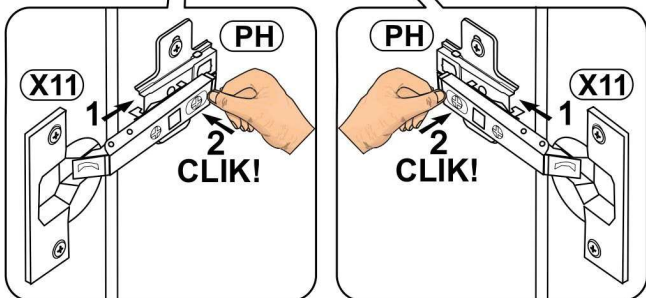
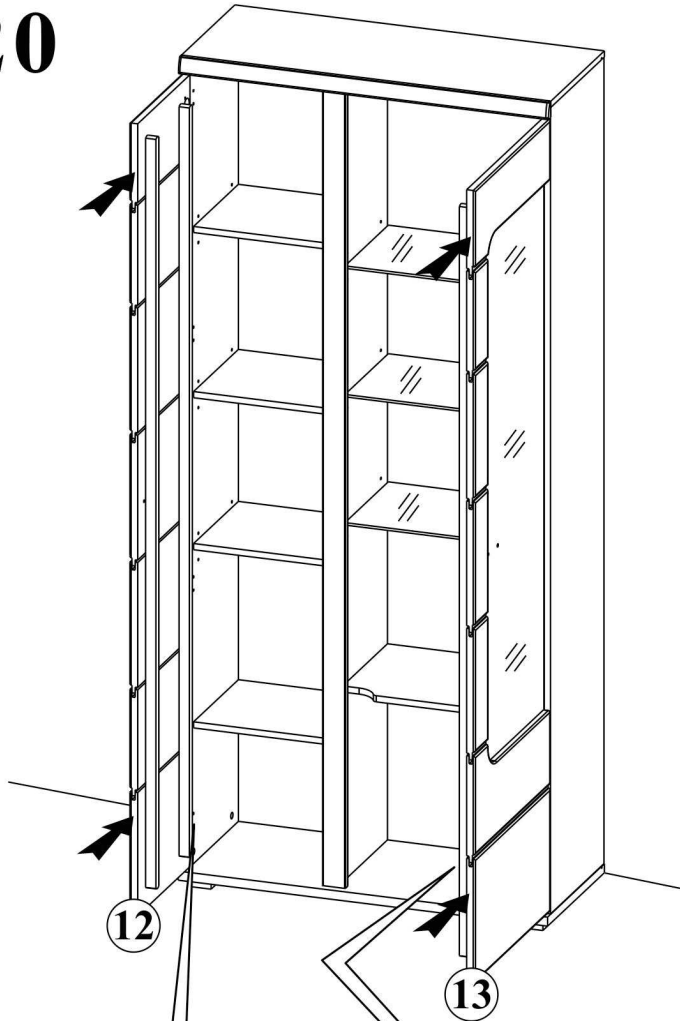

20

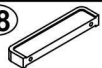

21

- U188**  x2
- A2**  M4x25 x2
- A4**  M4x12 x2
- G4**  L-4,5 φ7 x2
- C14**  x27

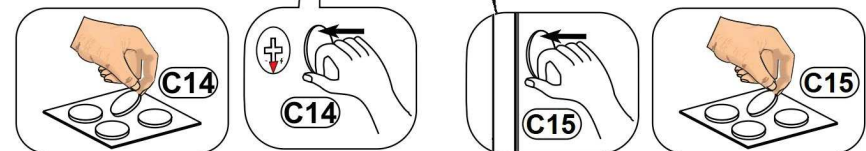
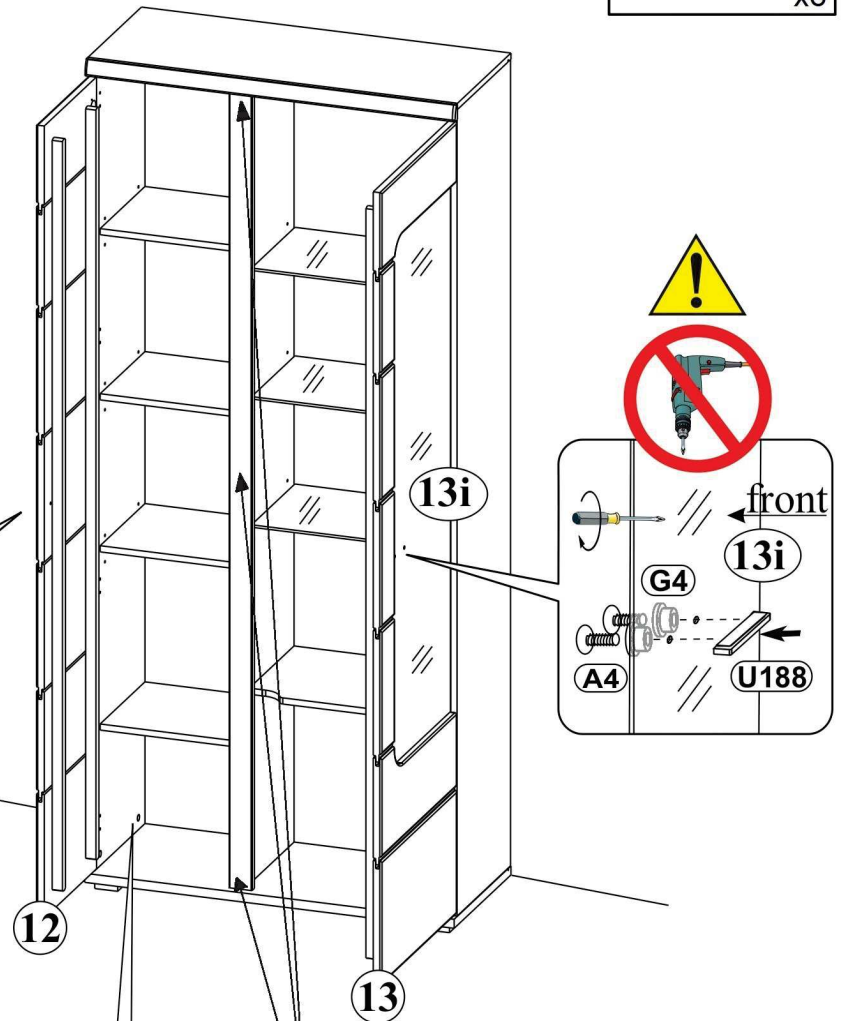
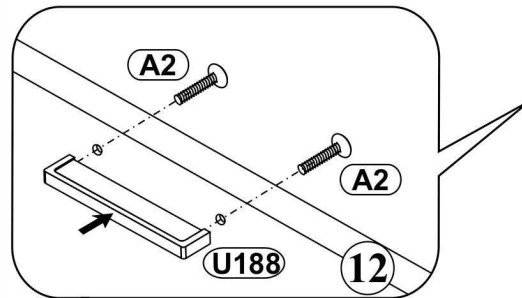

22

