

1

2

3

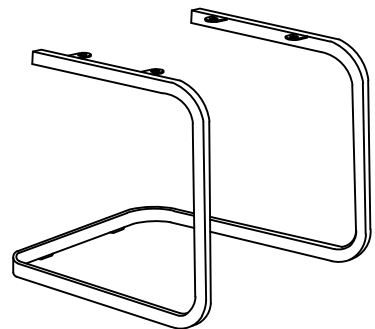
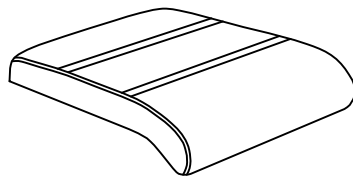
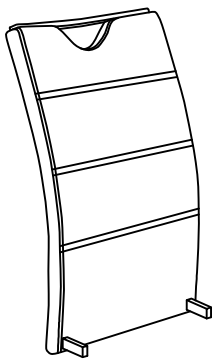

1	1x
2	1x
3	1x

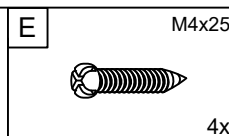
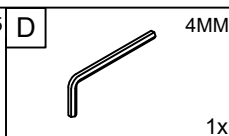
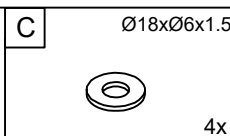
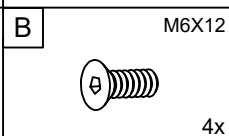
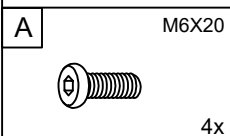
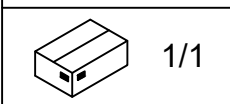

**I.**

**1**

E M4x25  
4x

F  
2x

100%

**2**

B M6x12  
4x

D 4MM  
1x

75%

**3**

A M6X20  
4x

C Ø18xØ6x1.5  
4x

D 4MM  
1x

75%

**4**

D 4MM  
1x

100%



Séparez les éléments avant de trier