

1

2

3

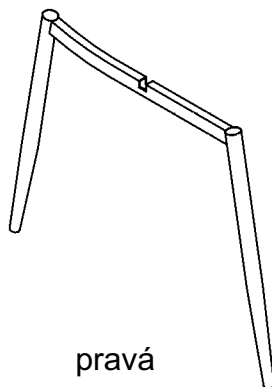
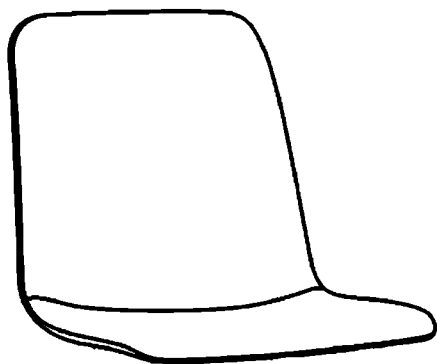

pravá

R

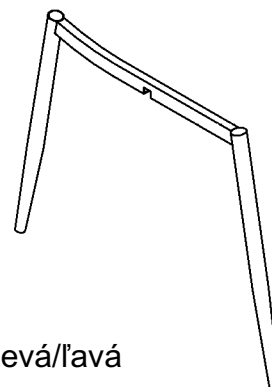

levá/lavá

L



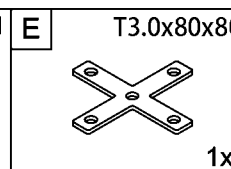
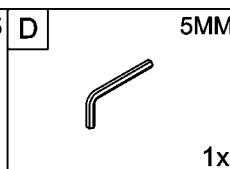
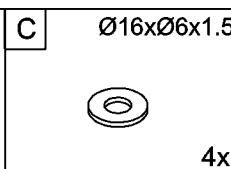
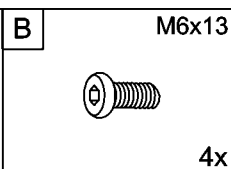
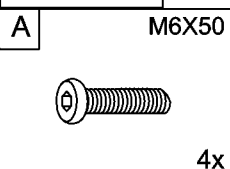
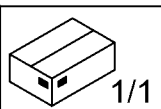

1	1 x
2	1 x
3	1 x

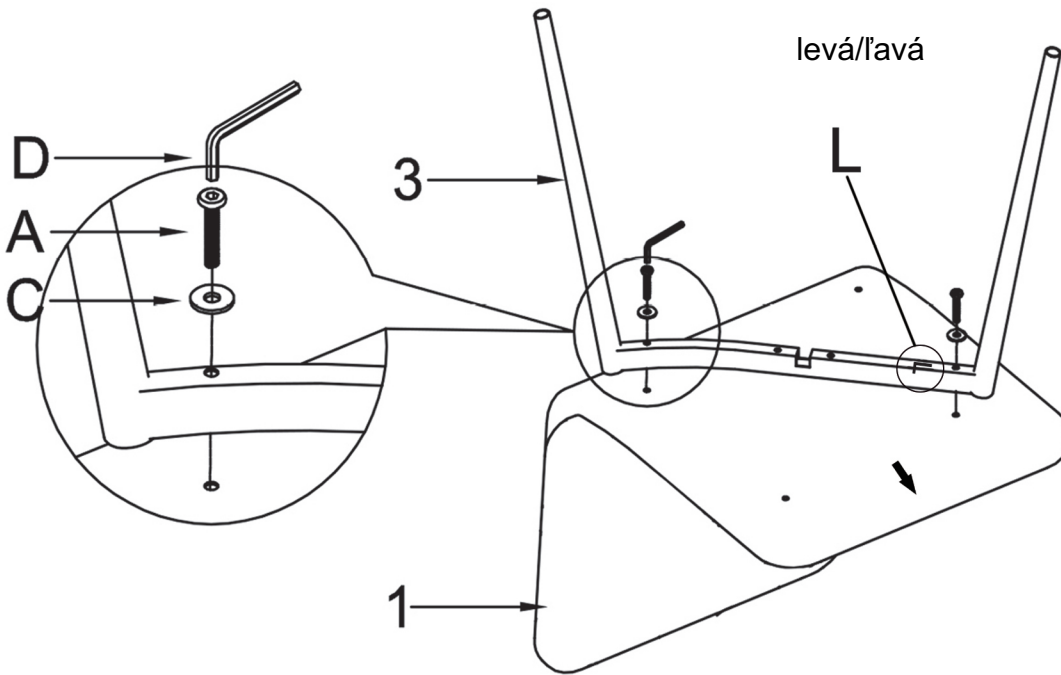

I.

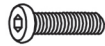



1

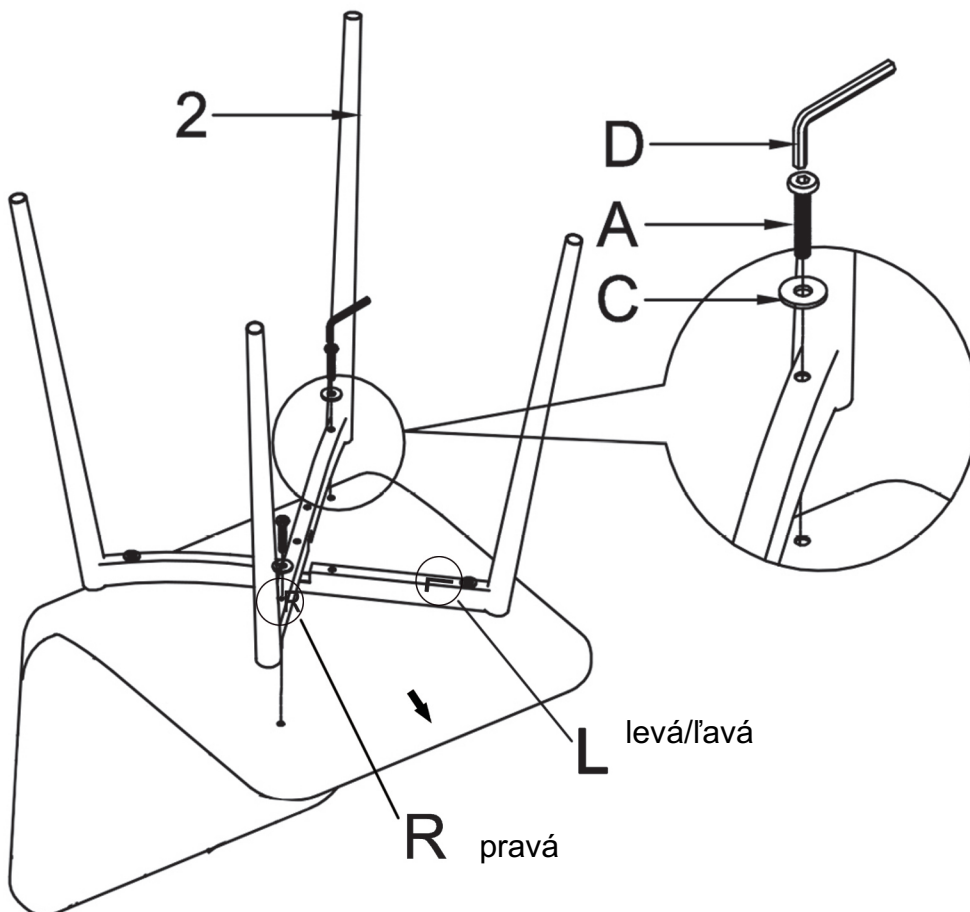

A	M6x50
	2x
C	Ø16xØ6x1.5
	2x
D	5MM
	1x
	

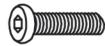
2





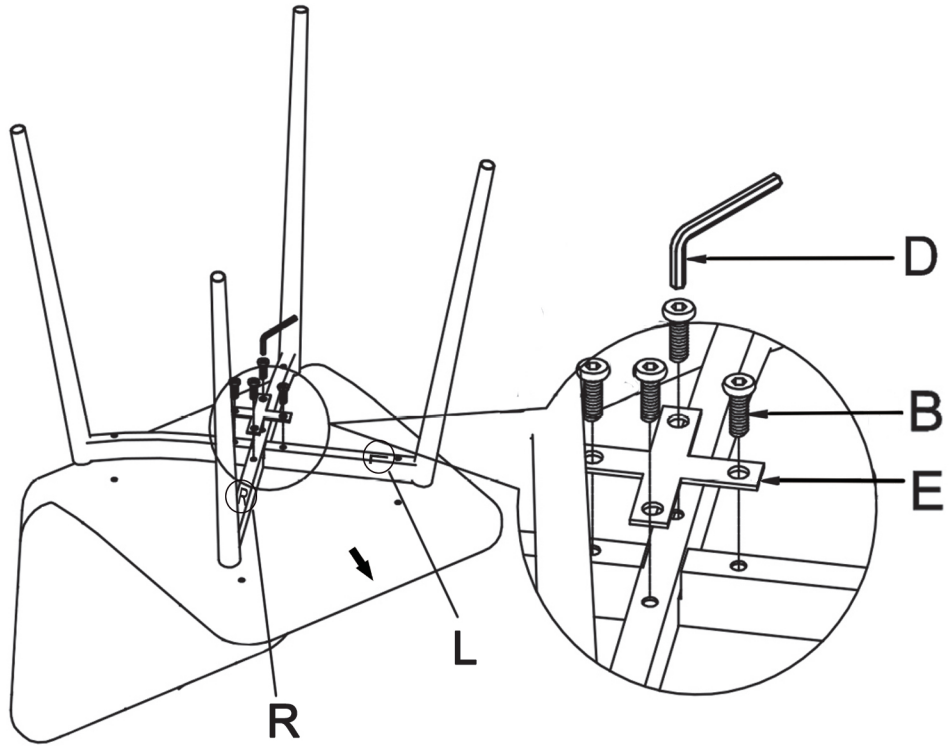

A	M6x50
	2x
C	Ø16xØ6x1.5
	2x
D	5MM
	1x
	

II.



3



- B** M6x13
 4x
 - D** 5MM
 1x
 - E** T3.0x80x80
 1x
- 

4



- E** 5MM
 1x
- 



LE TRI + FACILE

