

1

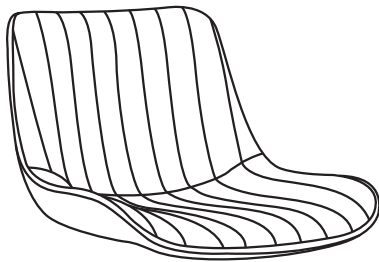

2

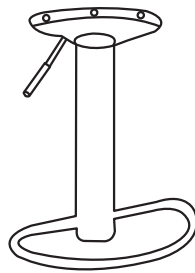

3



4

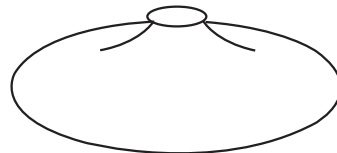

1	1x
2	1x
3	1x
4	1x



1/1

A



1X

B



4X

M6X16

C

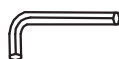

1X

I.

1.

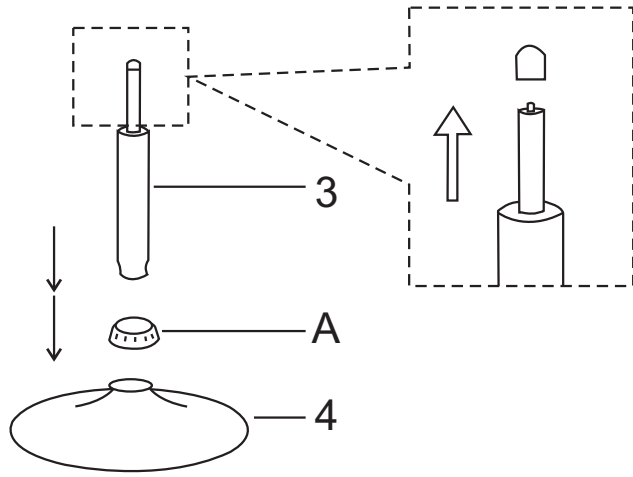

A

1X

75%

2.

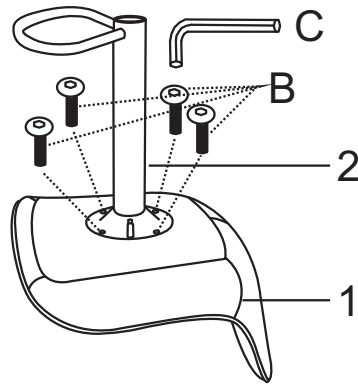

B

M6X16

4X

C

1X

100%



3.

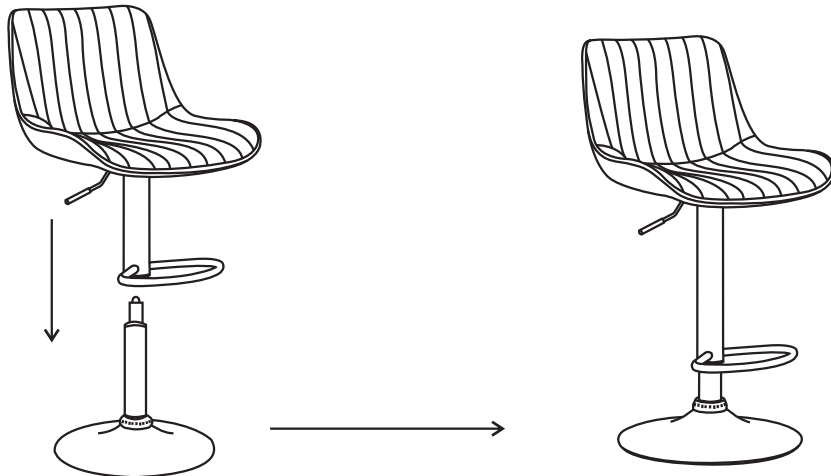

Séparez les éléments avant de trier