

A	B	C		D
1	VT2 -401	1777	670	1/2
2	VT2 -402	1777	61	1/2
3	VT2 -409	670	34	1/2
4	VT2 -410	1777	61	1/2

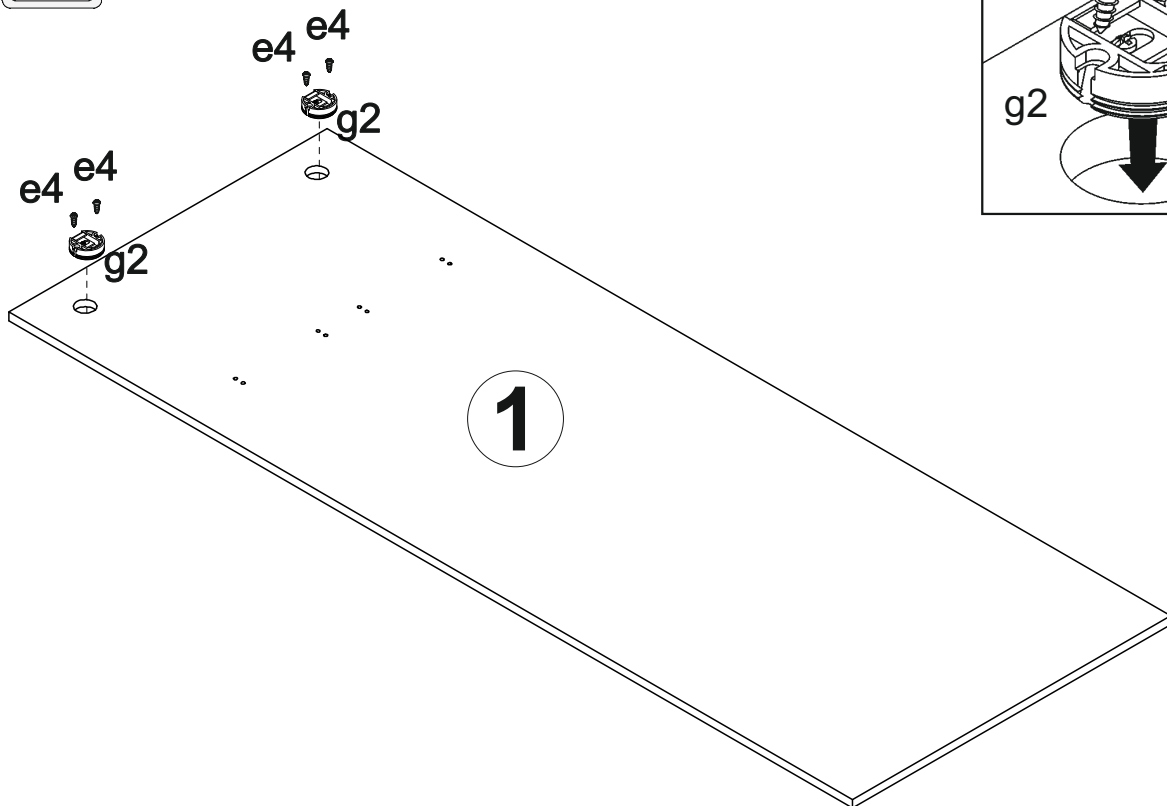

2

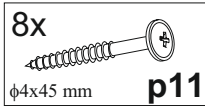
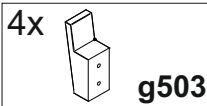
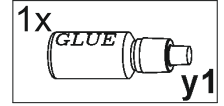
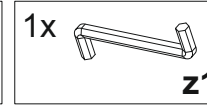
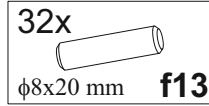
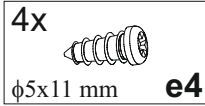
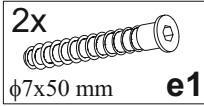
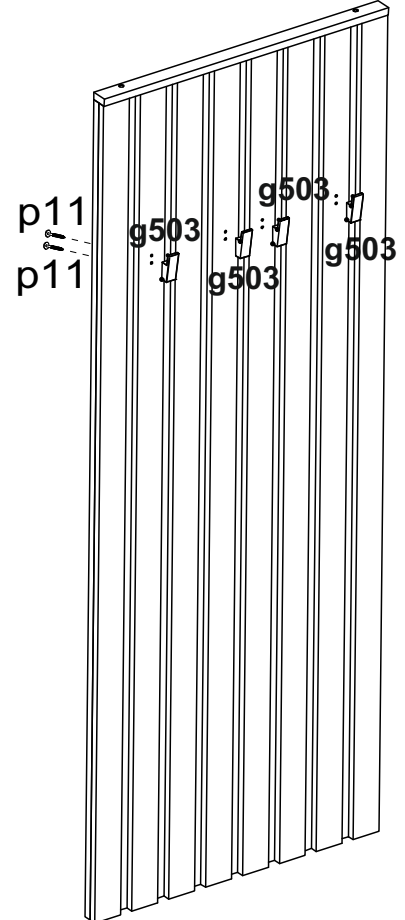
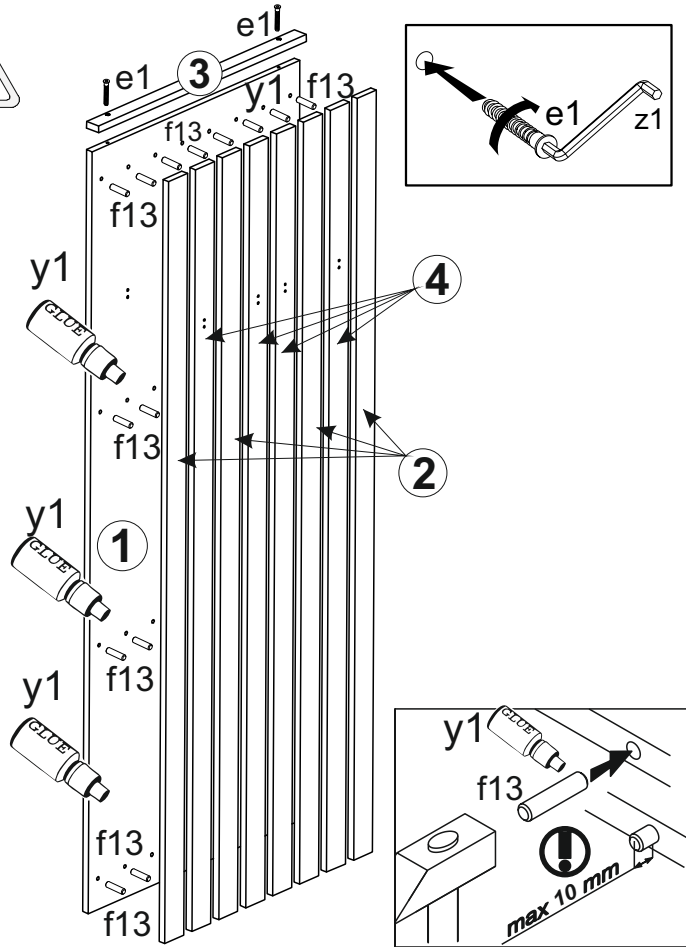

3

