

1

2

3

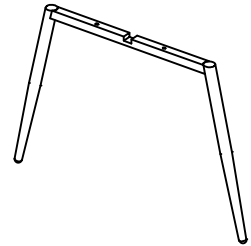
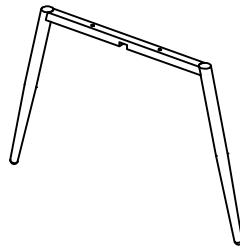
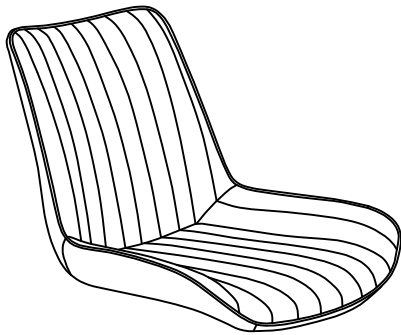

4

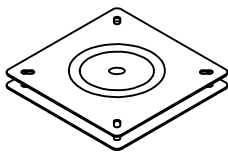

DT 266 N 160x160mm

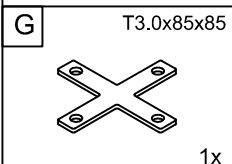
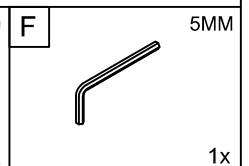
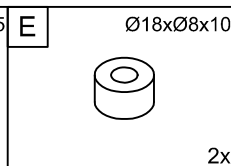
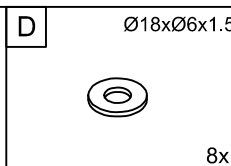
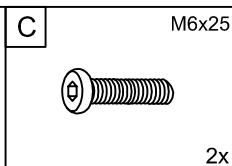
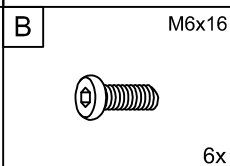
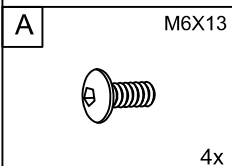
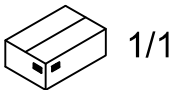

1	1 x
2	1 x
3	1 x
4	1 x



I.

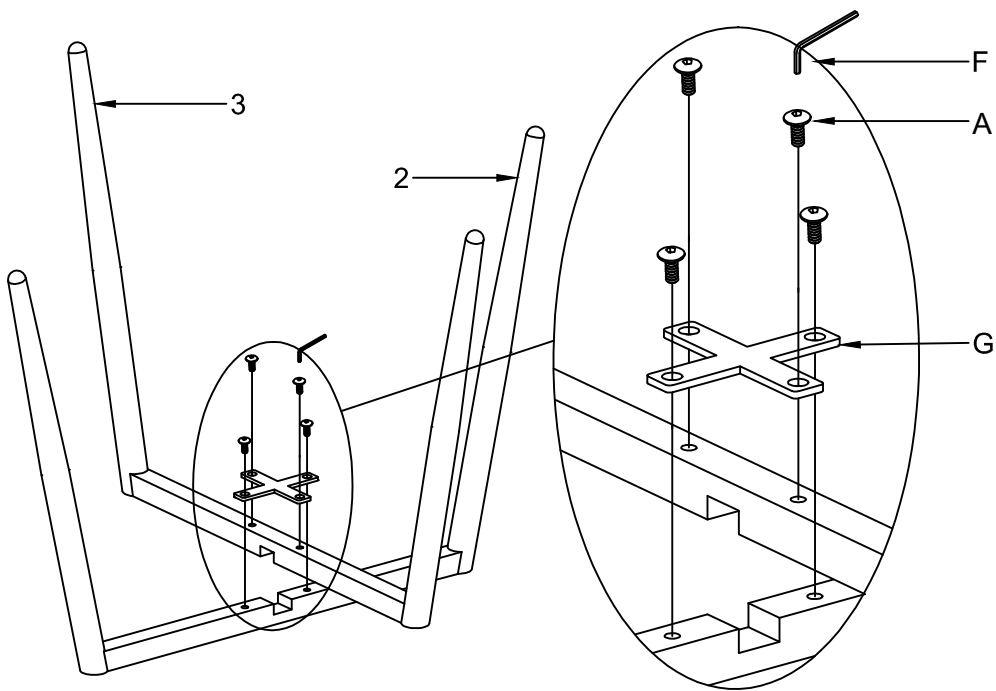

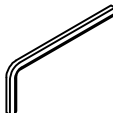
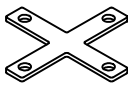

1

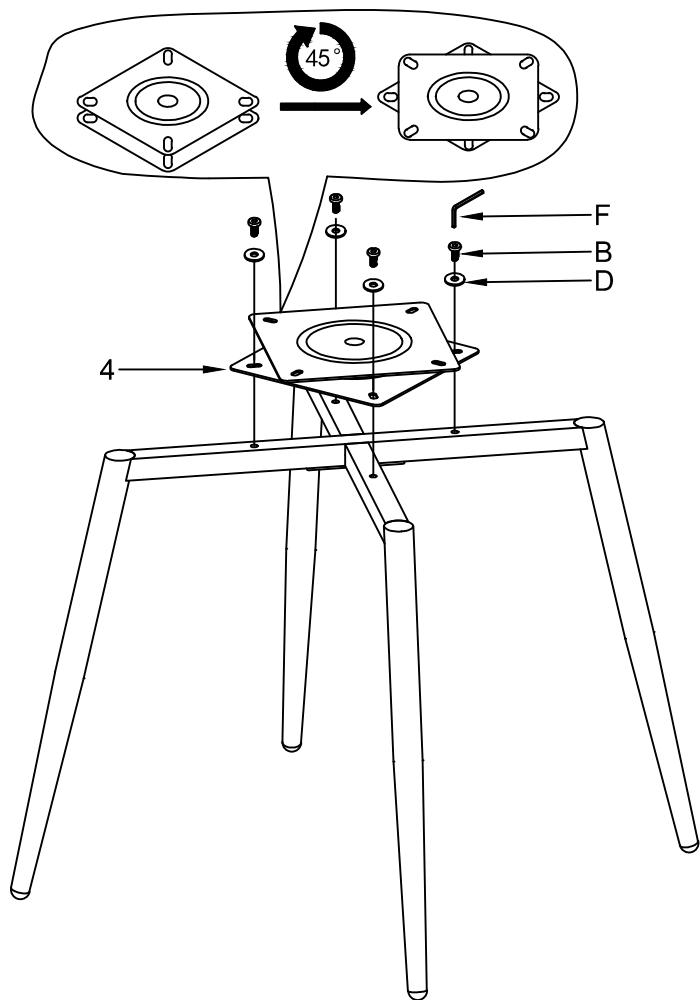

A	M6x13		4x
F	5MM		1x
G	T3.0x85x85		1x
			

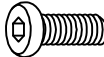
2

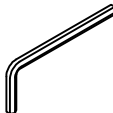





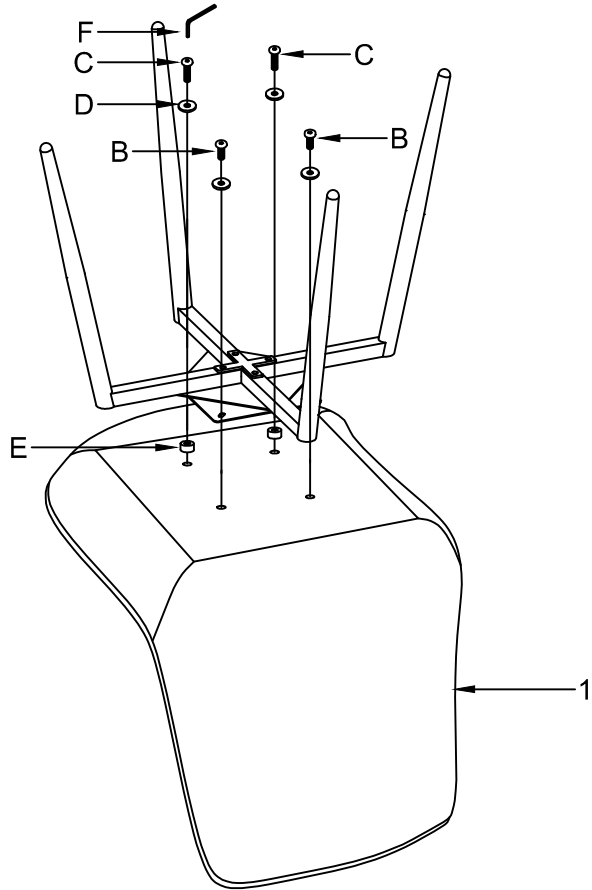

B	M6x16		4x
D	Ø18xØ6x1.5		4x
F	5MM		1x
			

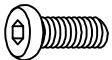
II.

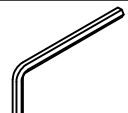

3

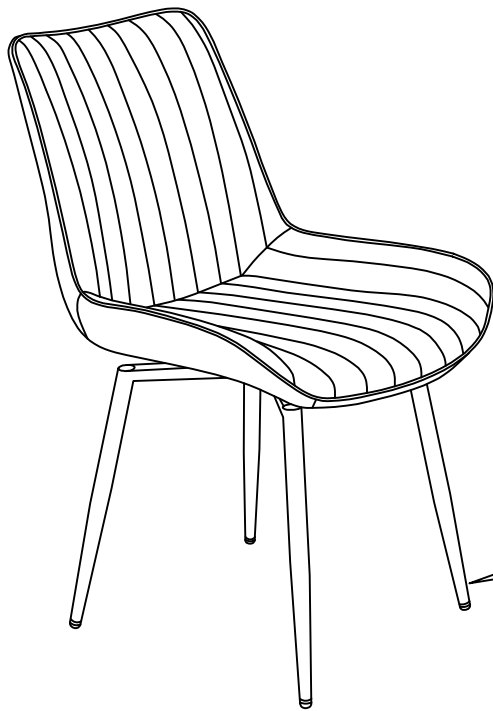

B	M6X16		2x
C	M6X25		2x
D	Ø18xØ6x1.5		4x
E	Ø18xØ8x10		2x
F	5MM		1x
			

4

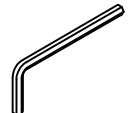

F	5MM		1x
			



LE TRI
+ FACILE



Séparez les éléments avant de trier