

CELINA

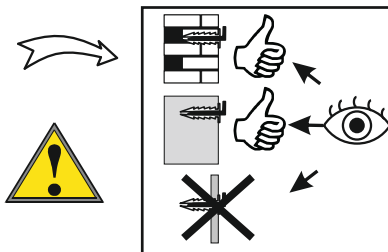

LEVÁ/ AVÁ PRAVÁ

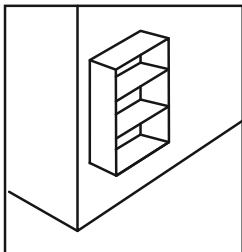
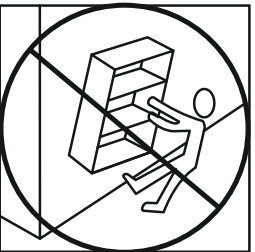
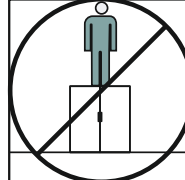
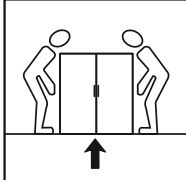
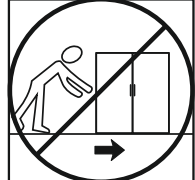
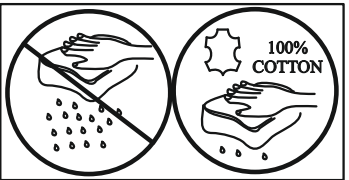
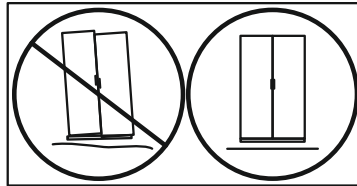
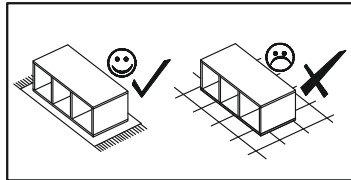
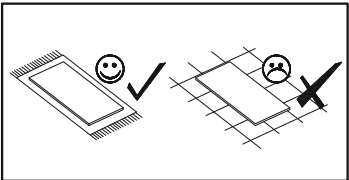
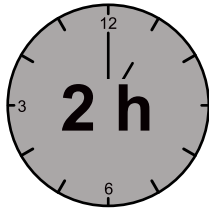
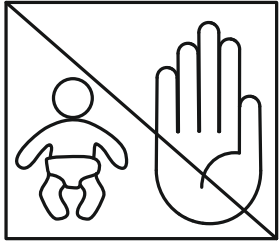
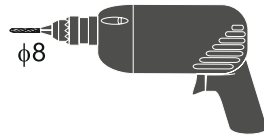
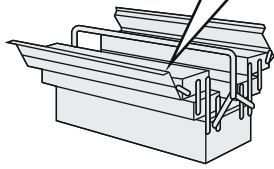
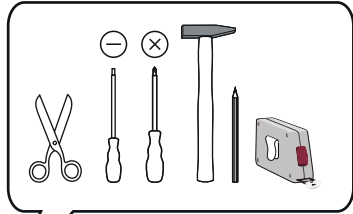
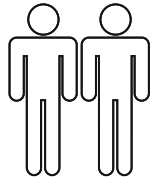
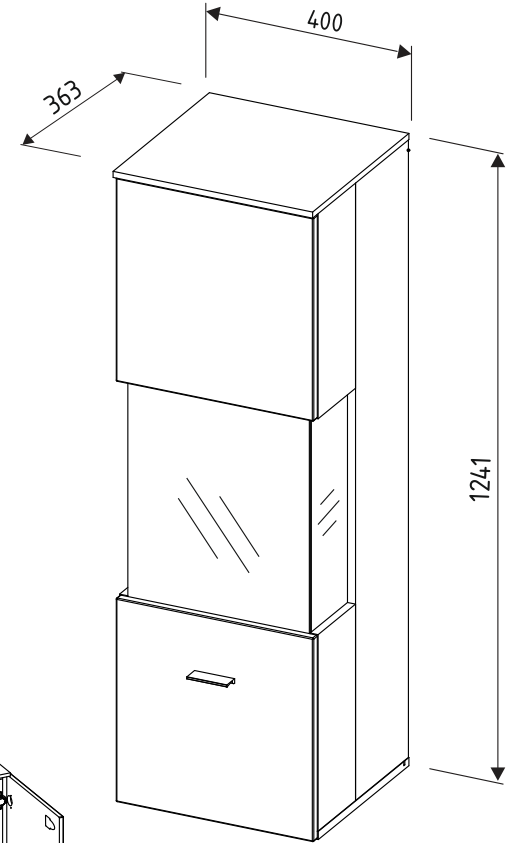
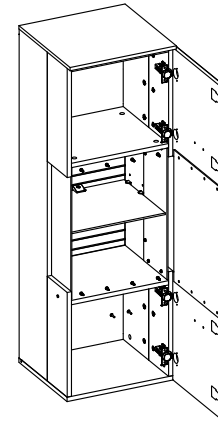
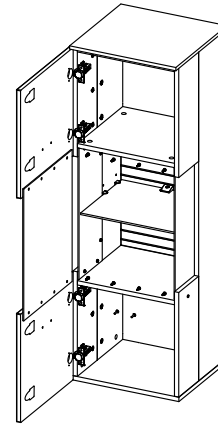

LE TRI + FACILE



FR
Donnez ou recyclez vos meubles.



ou



ou





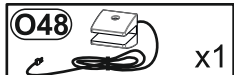
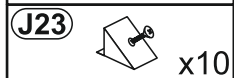
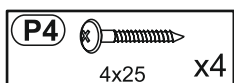
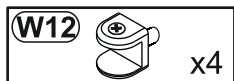
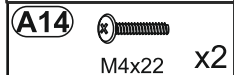
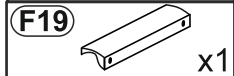
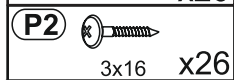
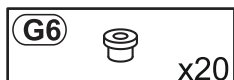
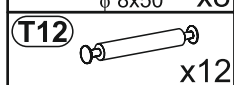
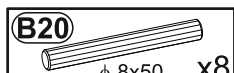
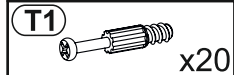
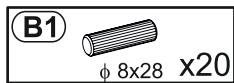

<https://quefairedemesdechets.fr>

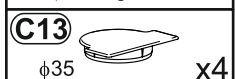
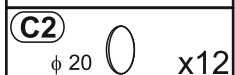
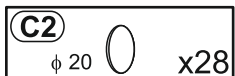
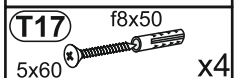
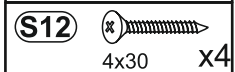
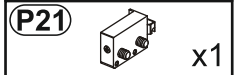
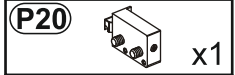
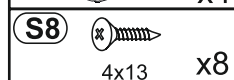
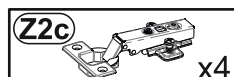

**SOK-OSW
-026-1**



Nr				pcs	
1	1213	205	16	1	2
2	404	134	16	1	1
3	385	134	16	1	1
4	1213	205	16	1	2
5	404	134	16	1	1
6	385	134	16	1	1
7	366	318	16	1	1
8	400	340	16	1	1
9	366	314	16	2	1
10	354	285	6	1	1
11	484	364	4	1	1
12	400	363	12	1	1
13	380	370	2	1	1
14	366	486	16	1	1
15	380	364	2	1	1
16	474	159	4	2	1
17	400	396	16	1	2
18	400	396	16	1	2

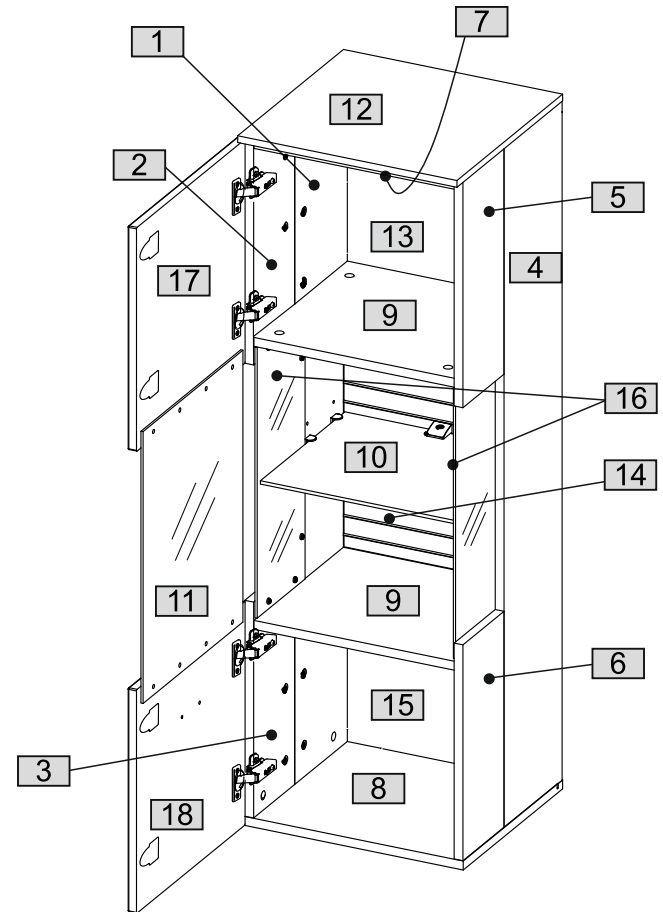

1

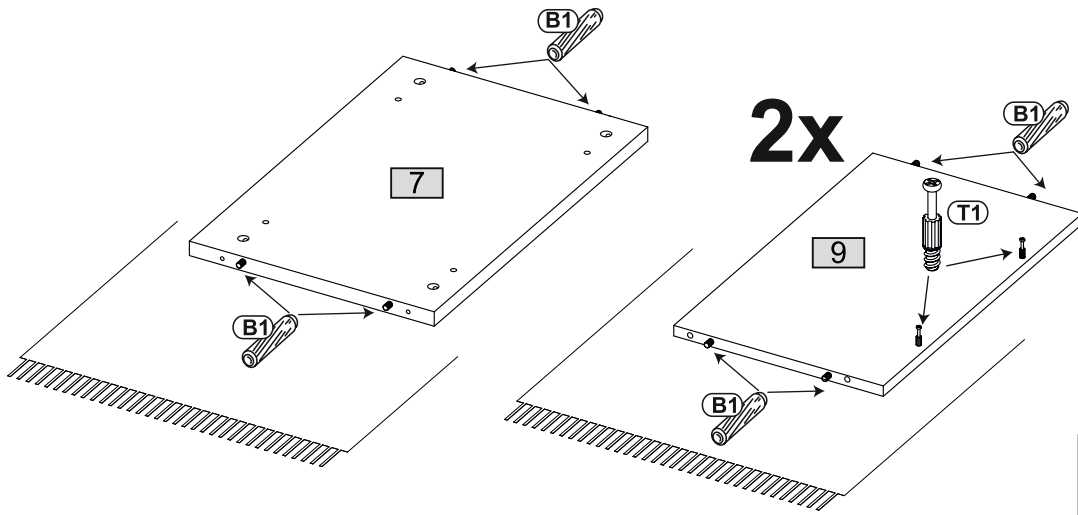
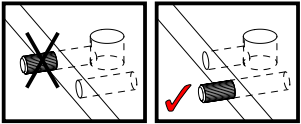
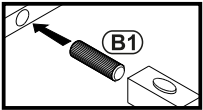
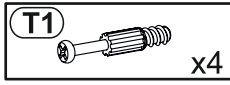
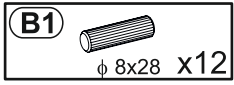

2

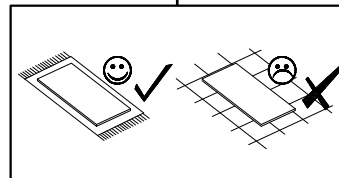
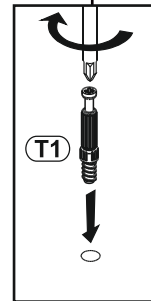
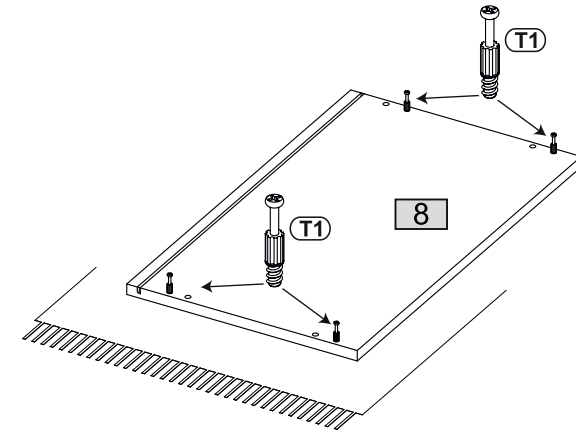
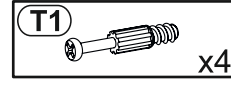

3

- S12** 4x30 x4
- P20** x1
- P21** x1

- T1** x6
- B1** ϕ 8x28 x4

- B20** ϕ 8x50 x4

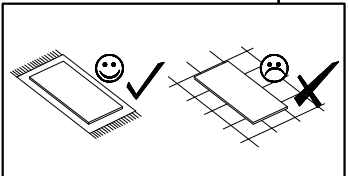
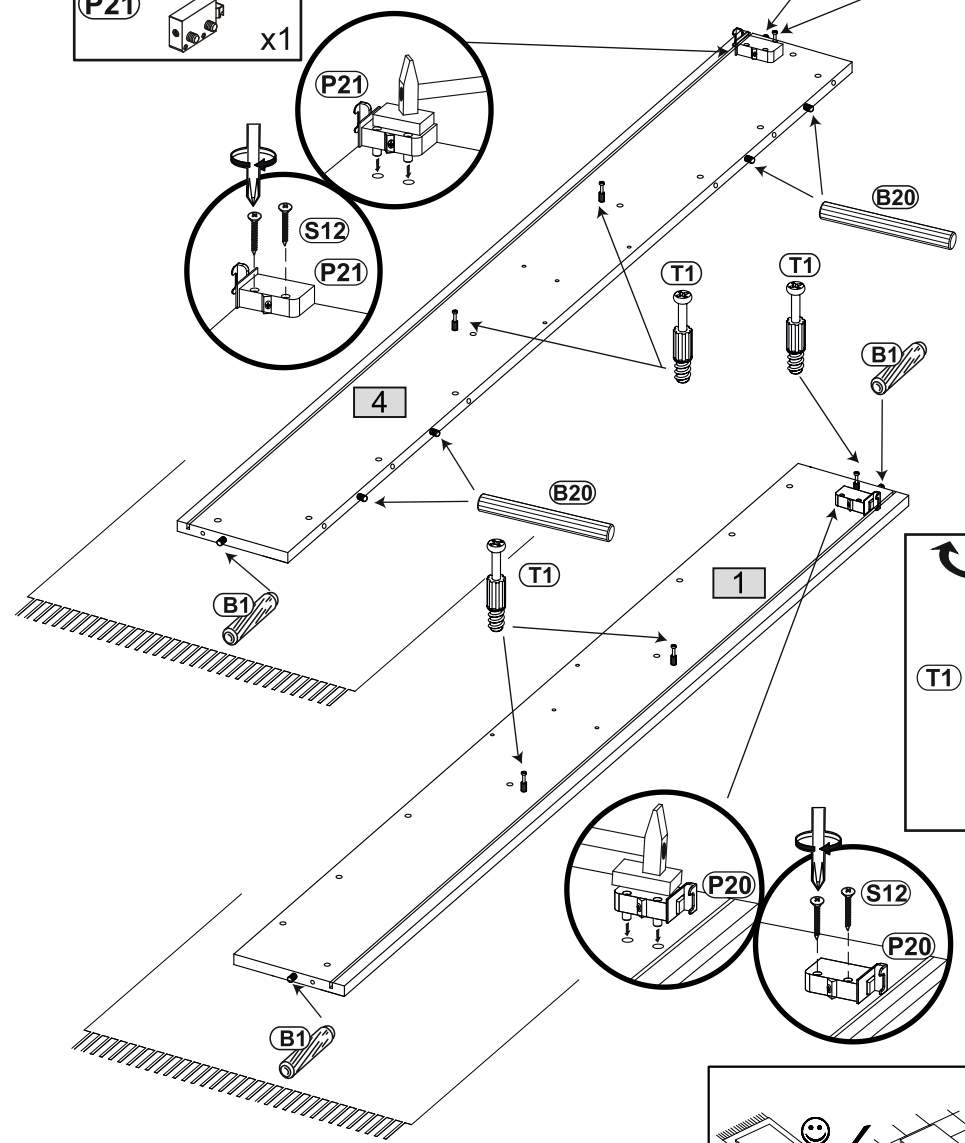

4

- B1** ϕ 8x28 x4
- B20** ϕ 8x50 x4

- T1** x6

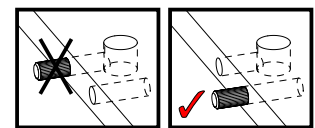
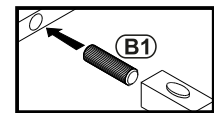
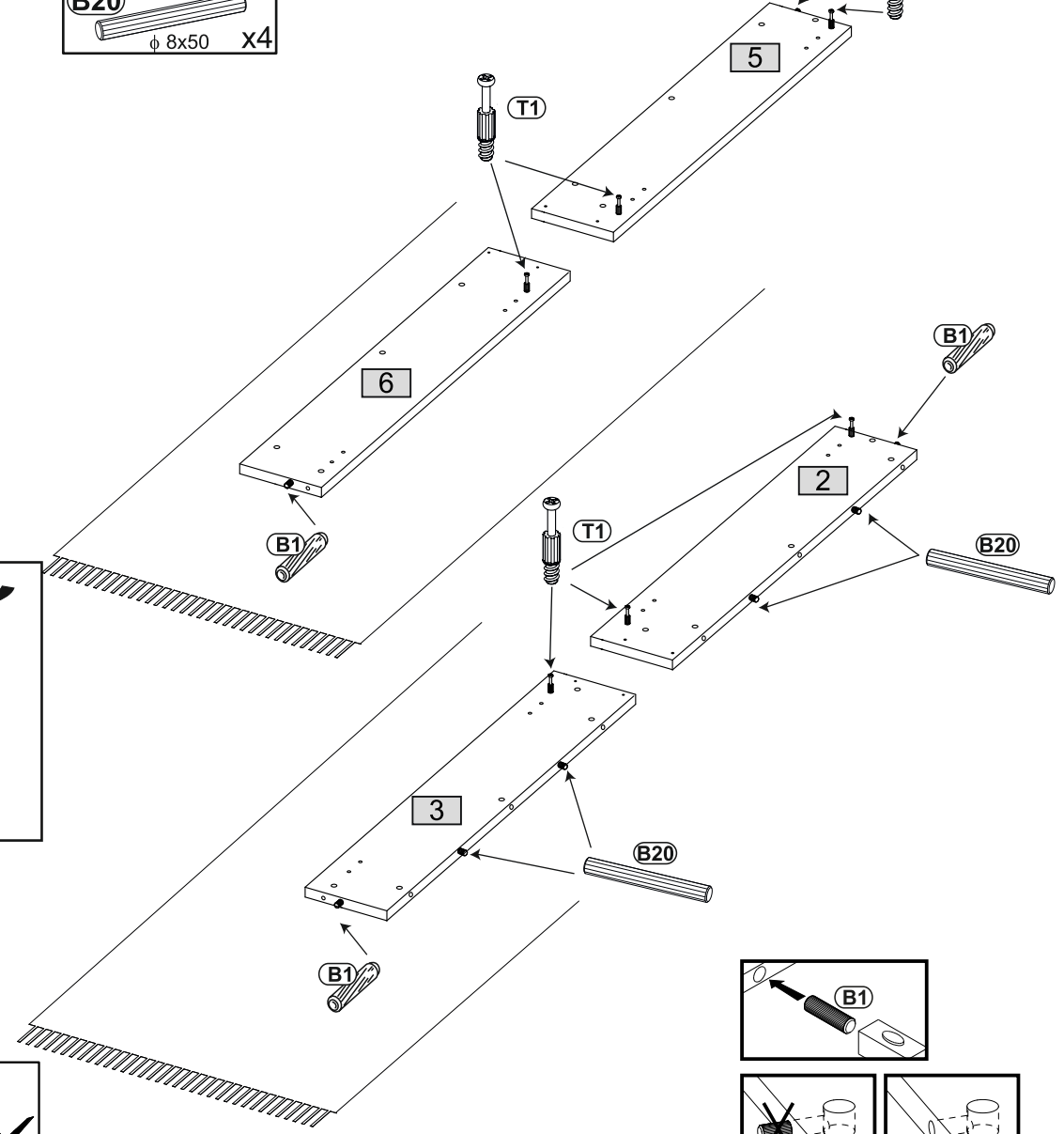

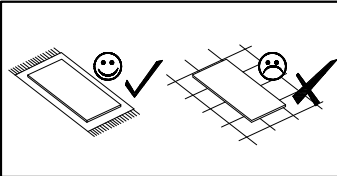
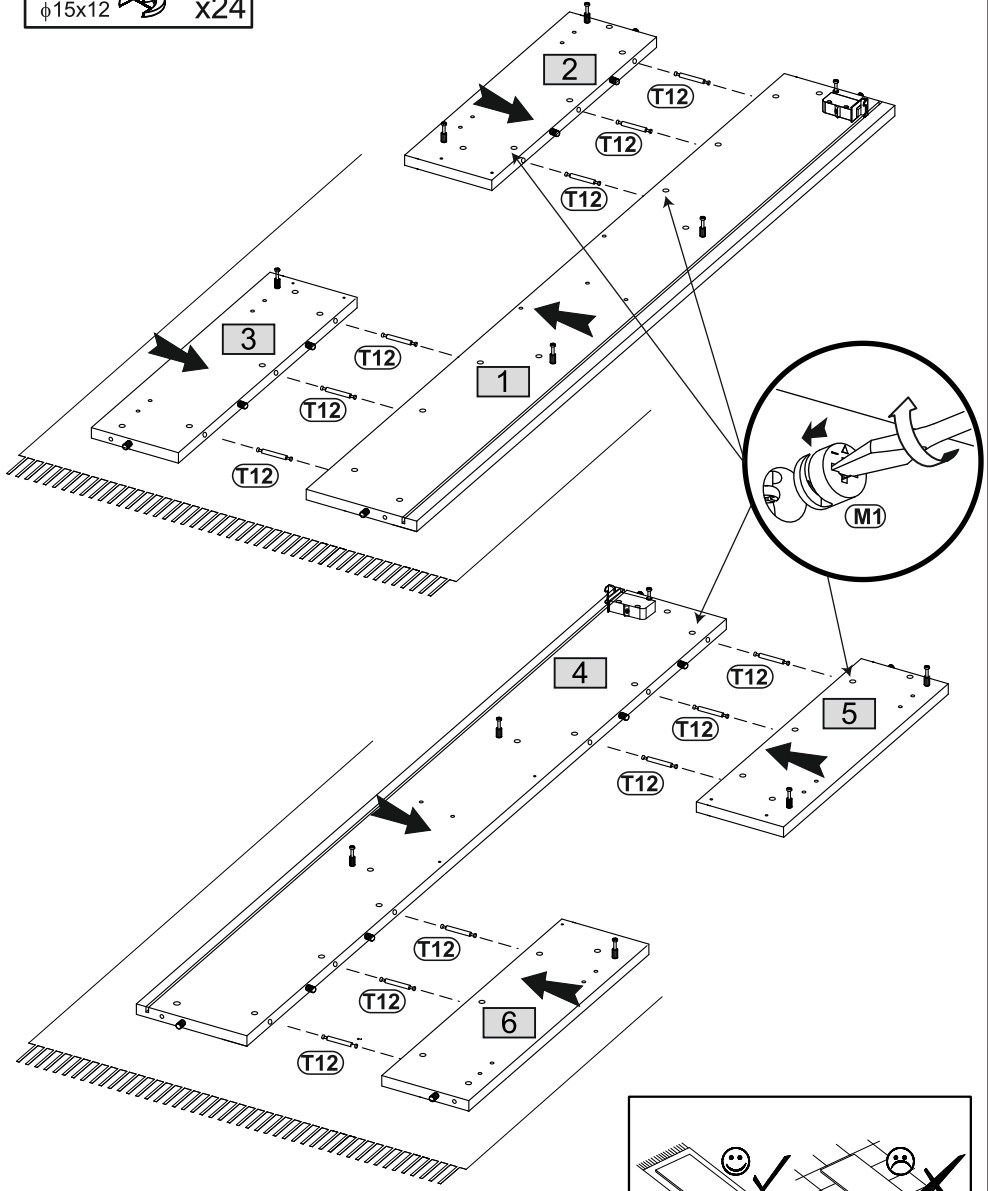
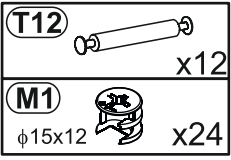

5

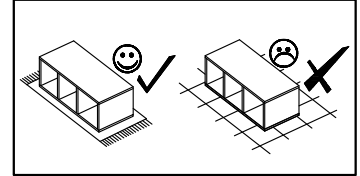
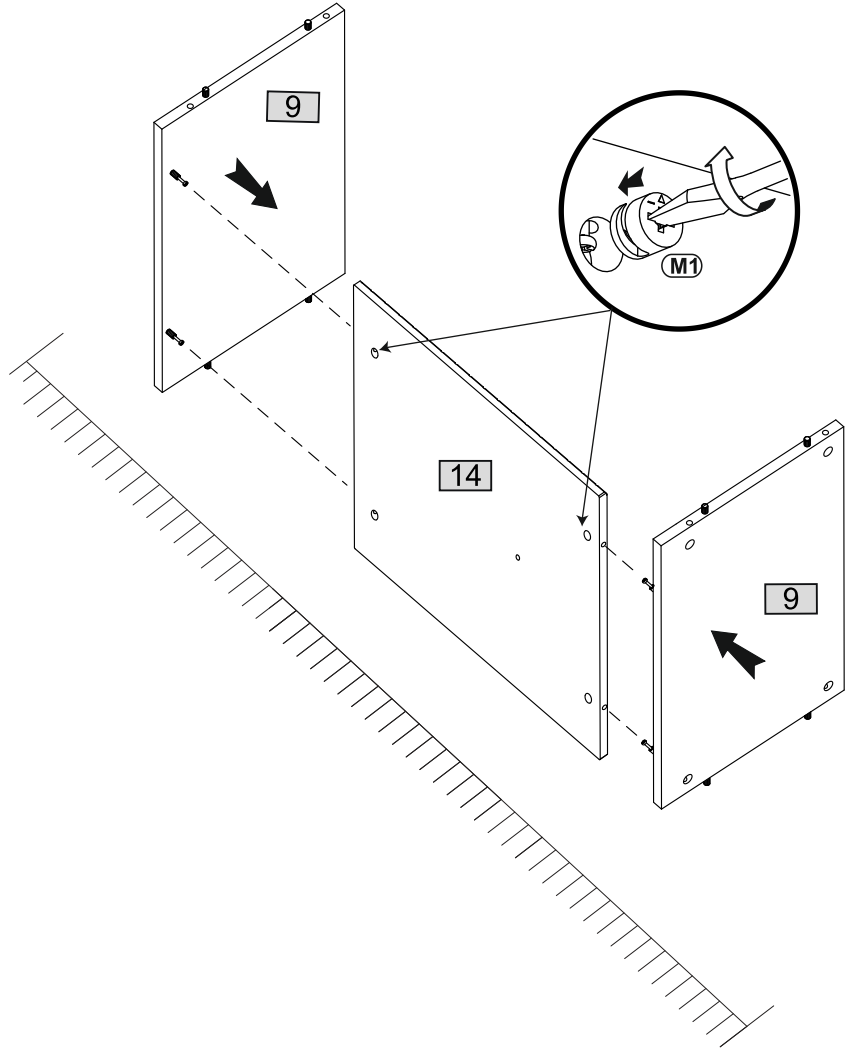

6





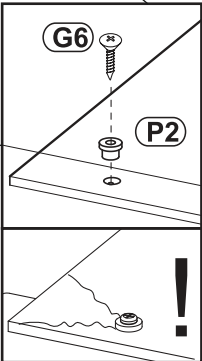
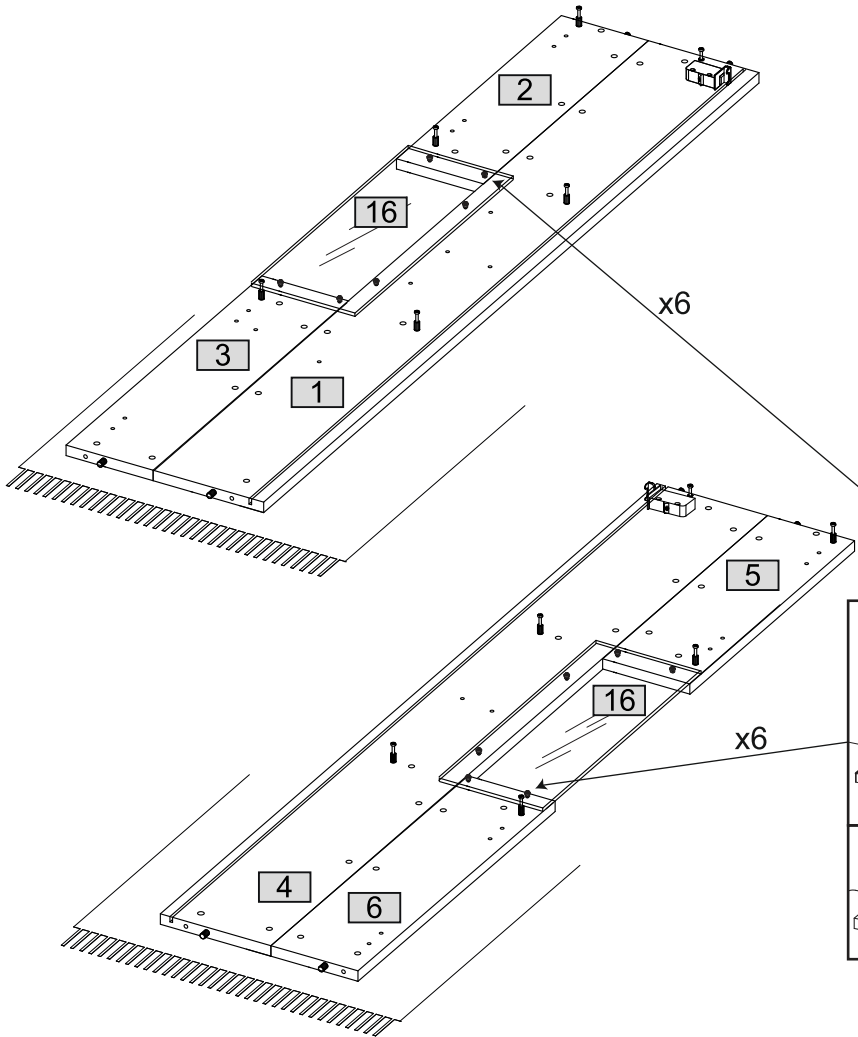
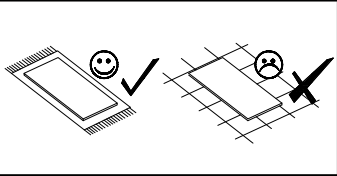

7

- G6**  x12
- P2**  3x16 x12



8

- Z2c**  x4
- S8**  4x13 x8

- G6**  x8
- P2**  3x16 x8
- C13**  $\phi 35$ x4

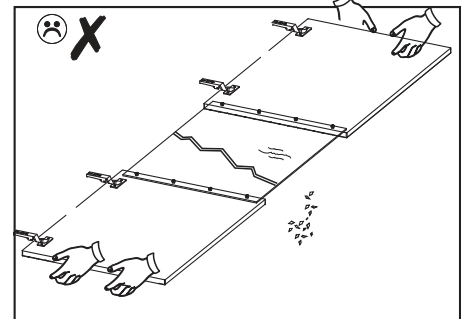
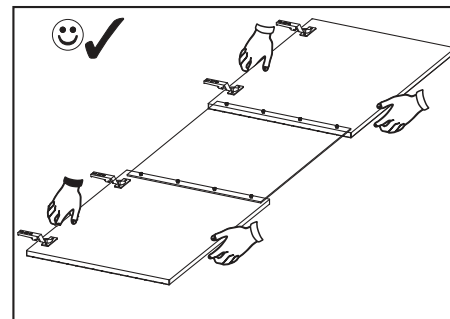
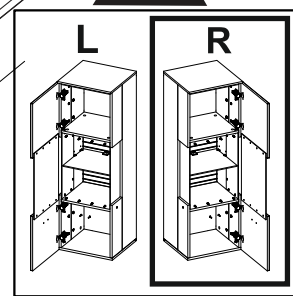
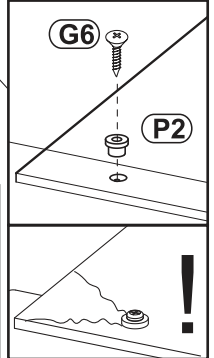
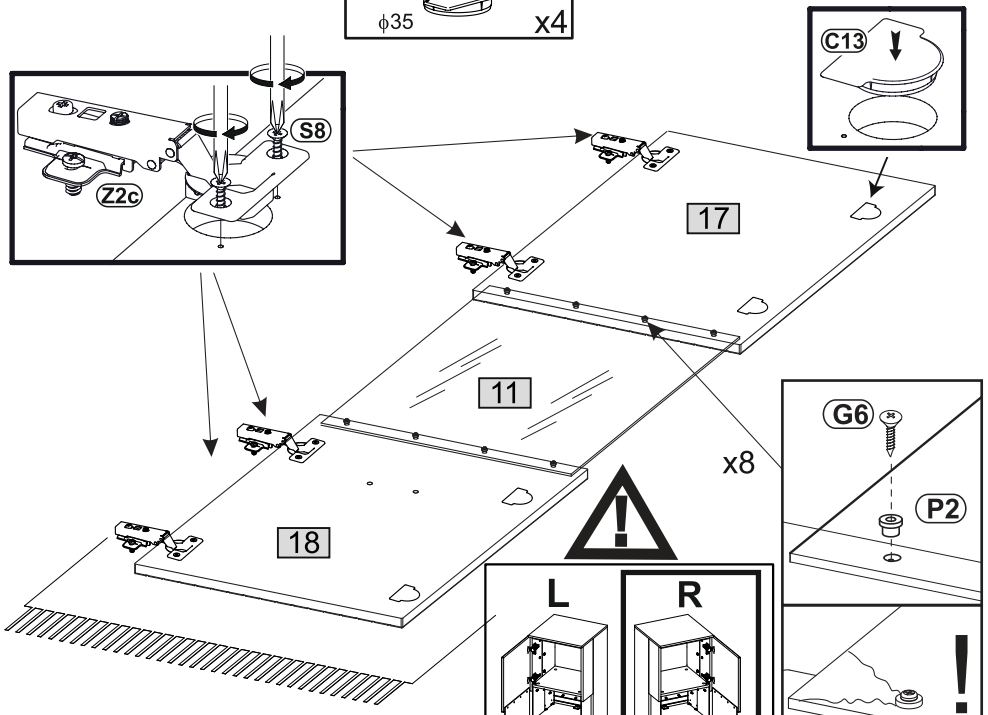
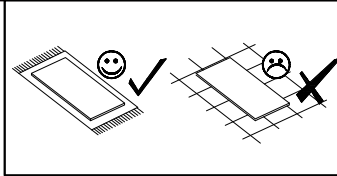

9

M1
φ15x12
x4

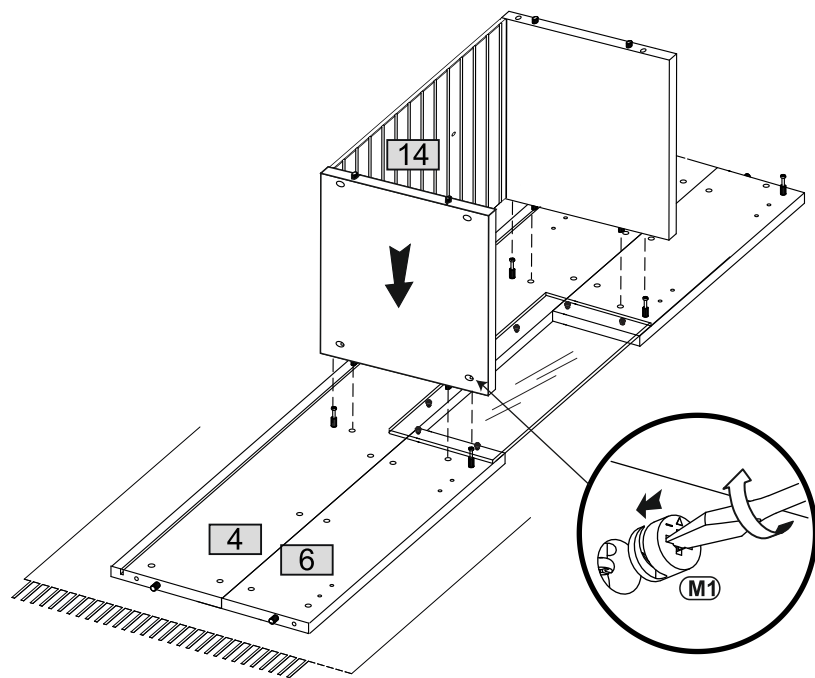

10

M1
φ15x12
x2

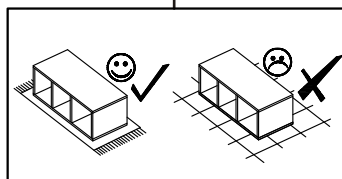
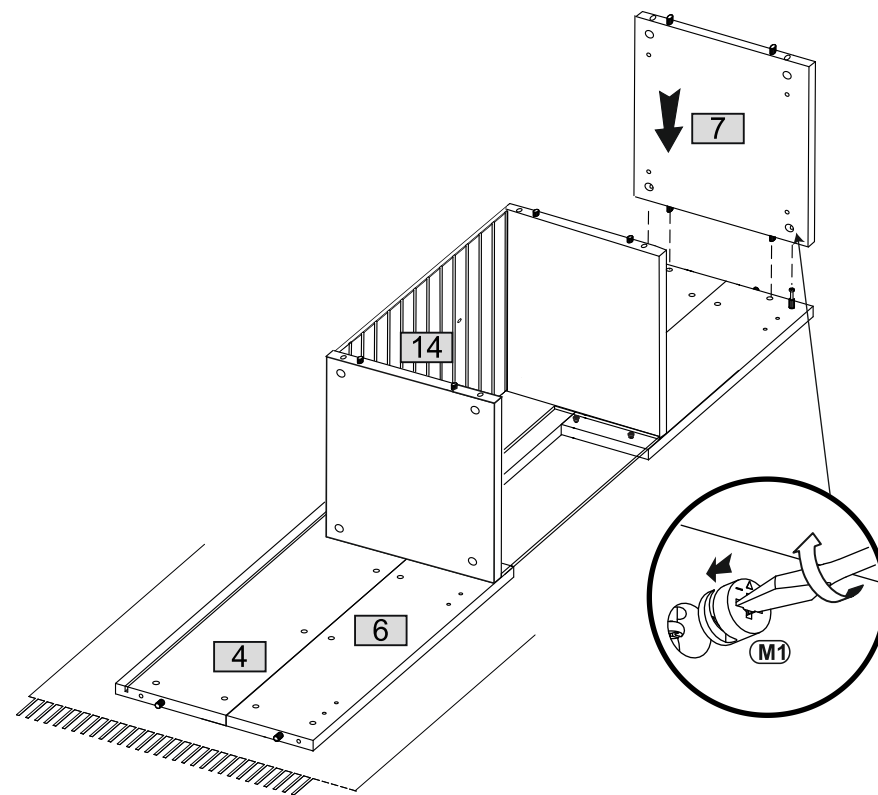

11

M1
φ15x12
x6

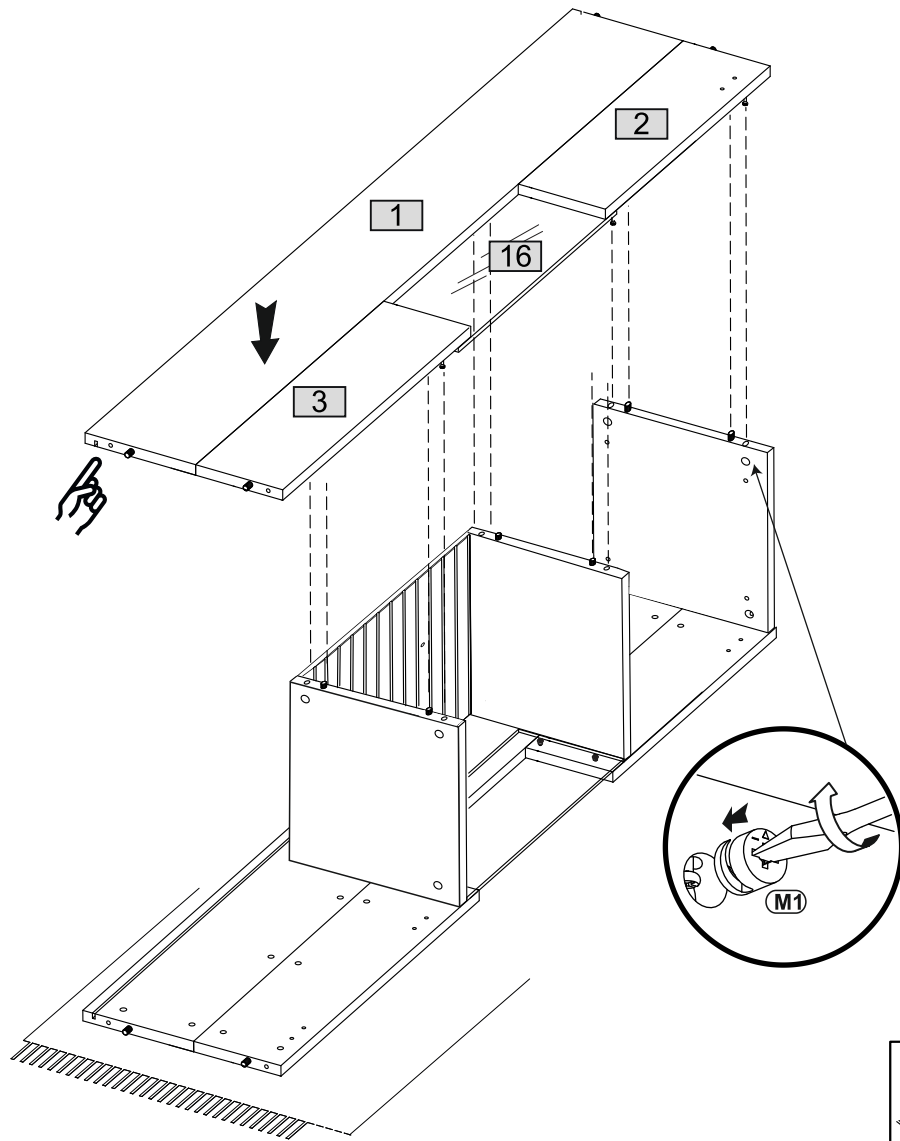

12

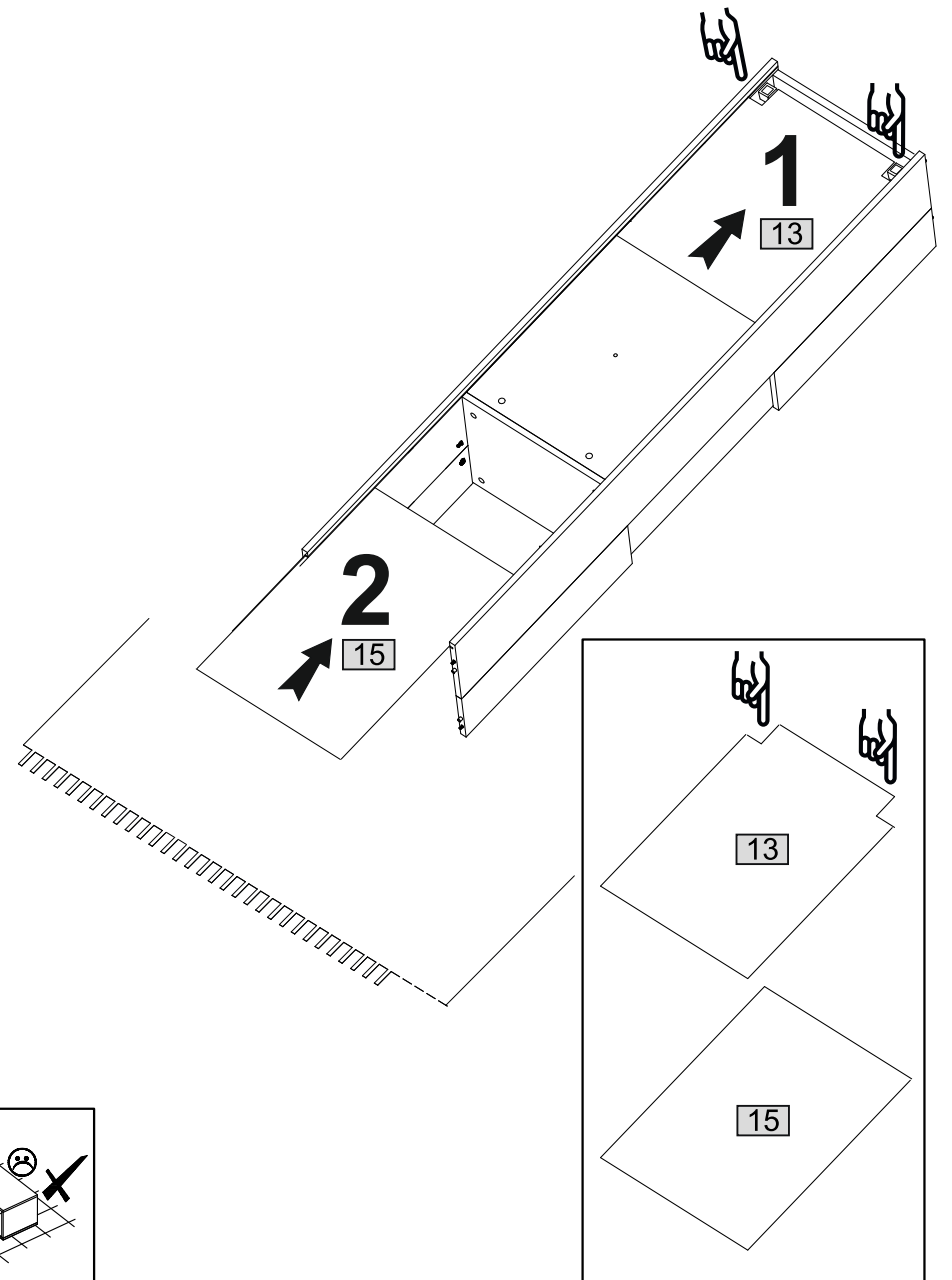

13

M1
φ15x12 x4

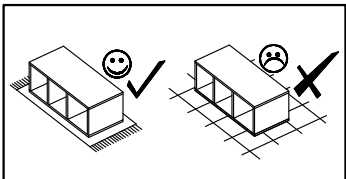
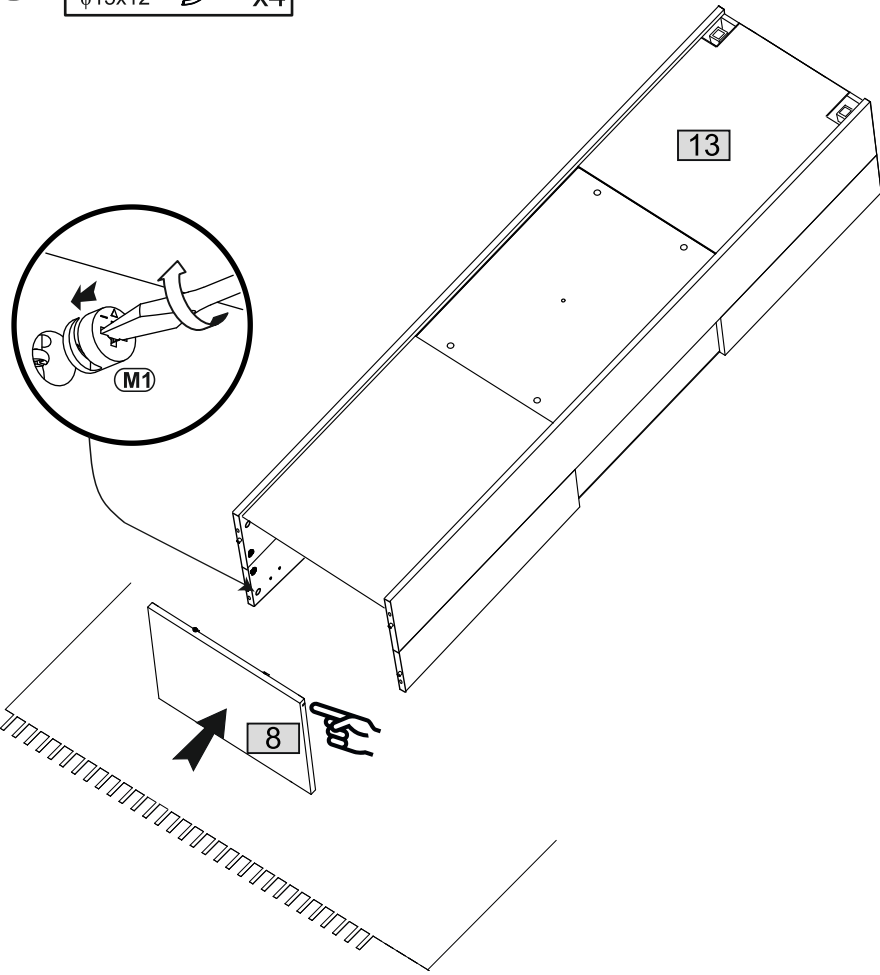

14

J23 x10
P2 3x16 x6

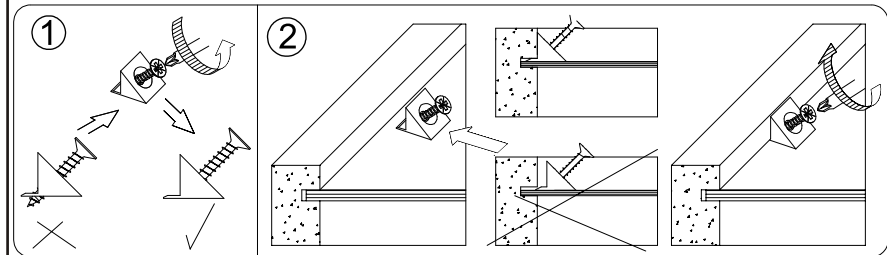
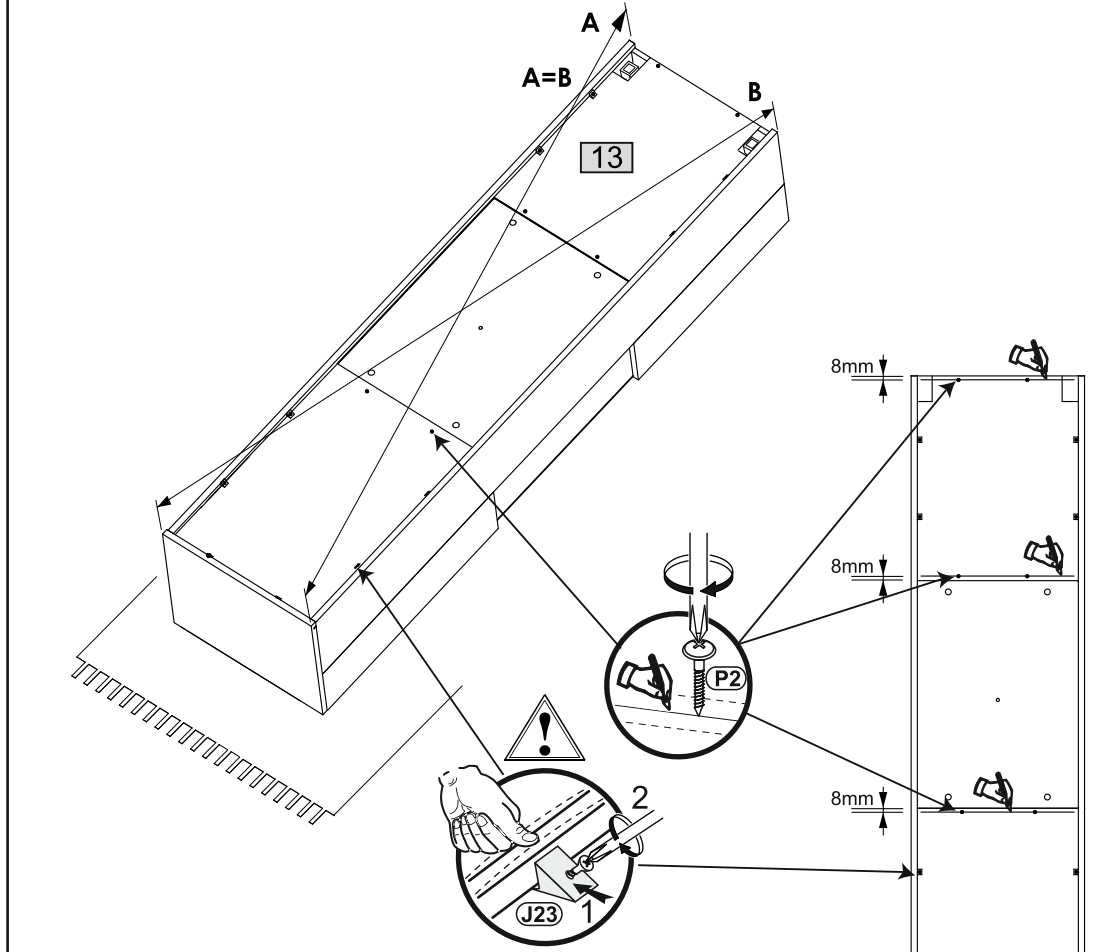
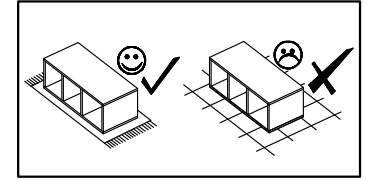

15 **P4** 4x25 x4

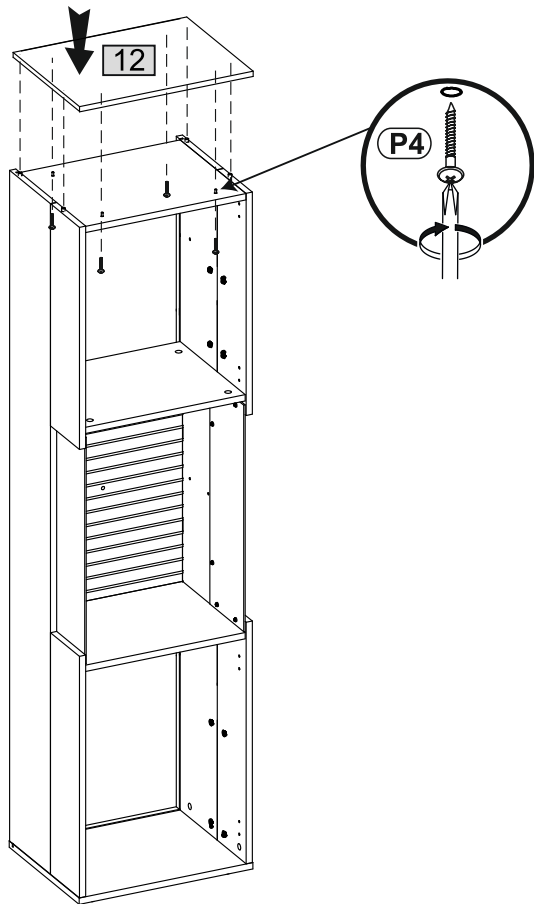

16 **W12** x4
C2 ϕ 20 x28
C2 ϕ 20 x12

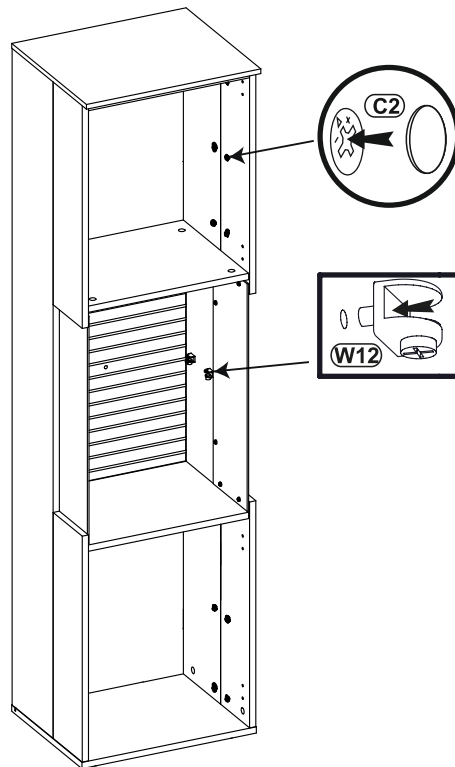

17 **O48** x1
O51 x1
SOK-OSW -026-1

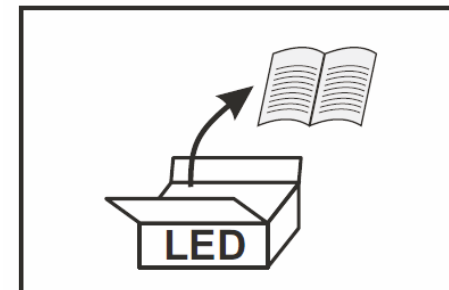
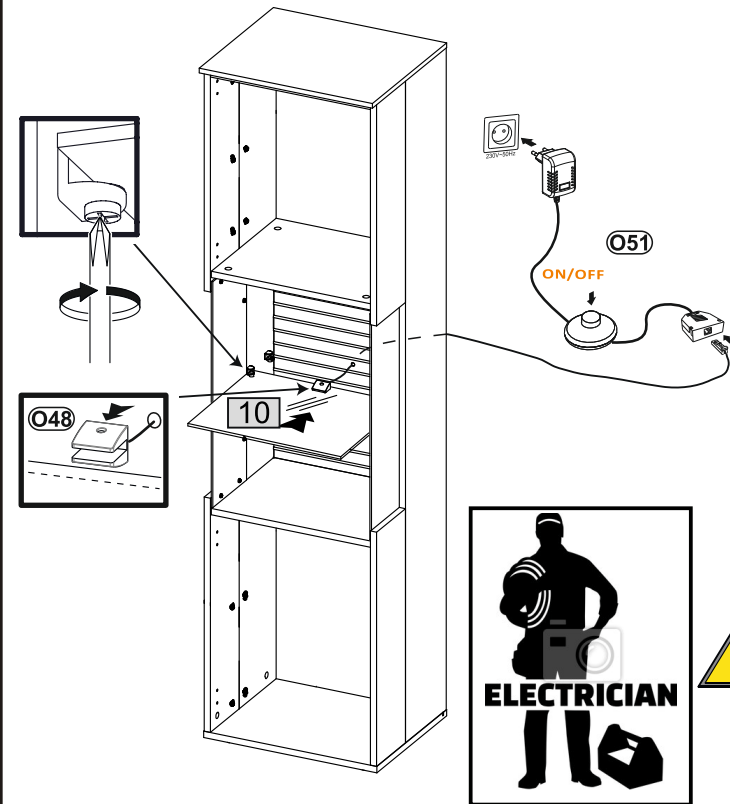

18

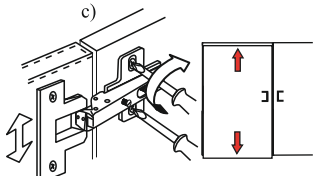
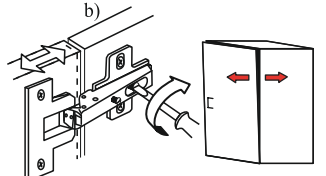
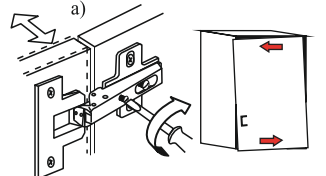
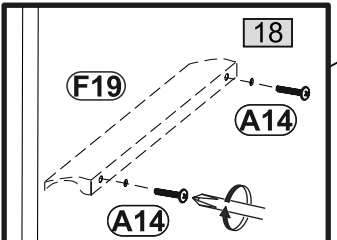
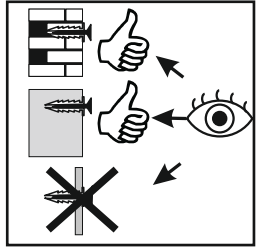
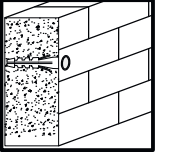
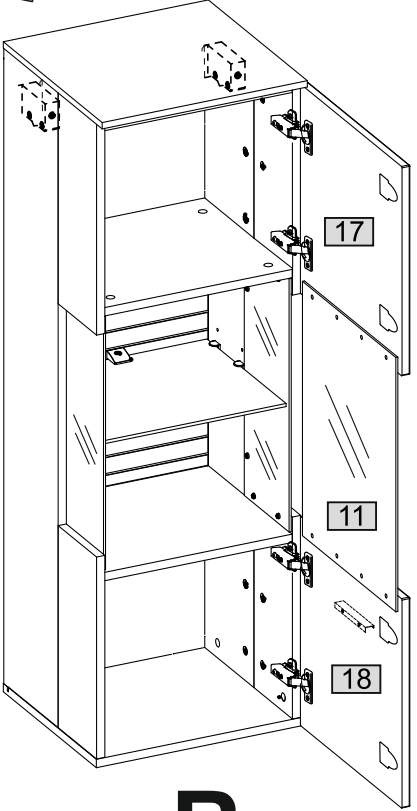
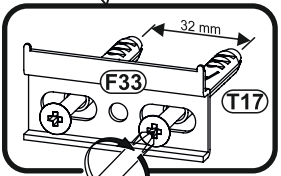
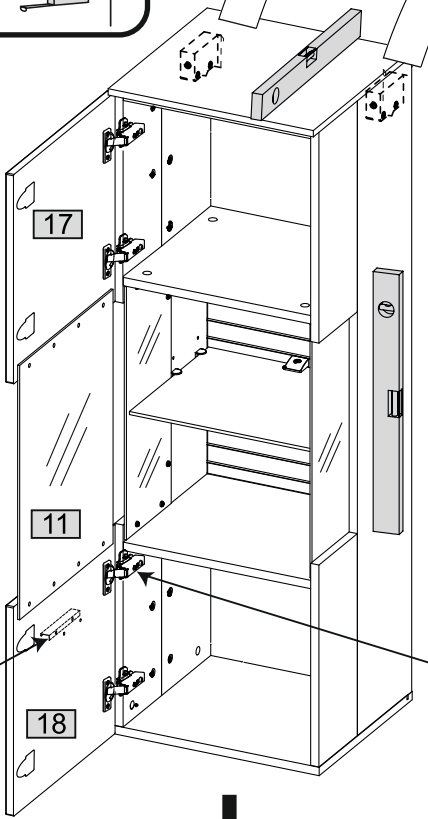
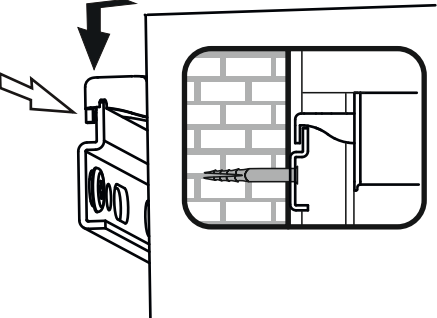
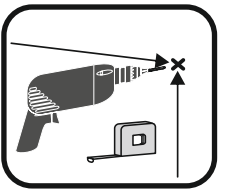
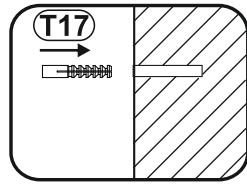
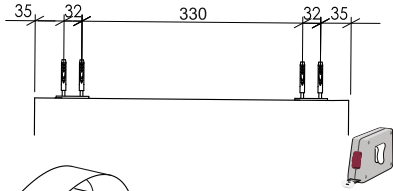
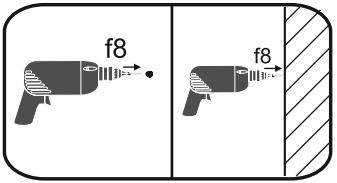
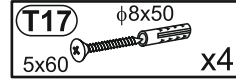
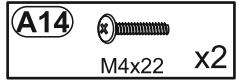
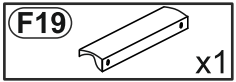

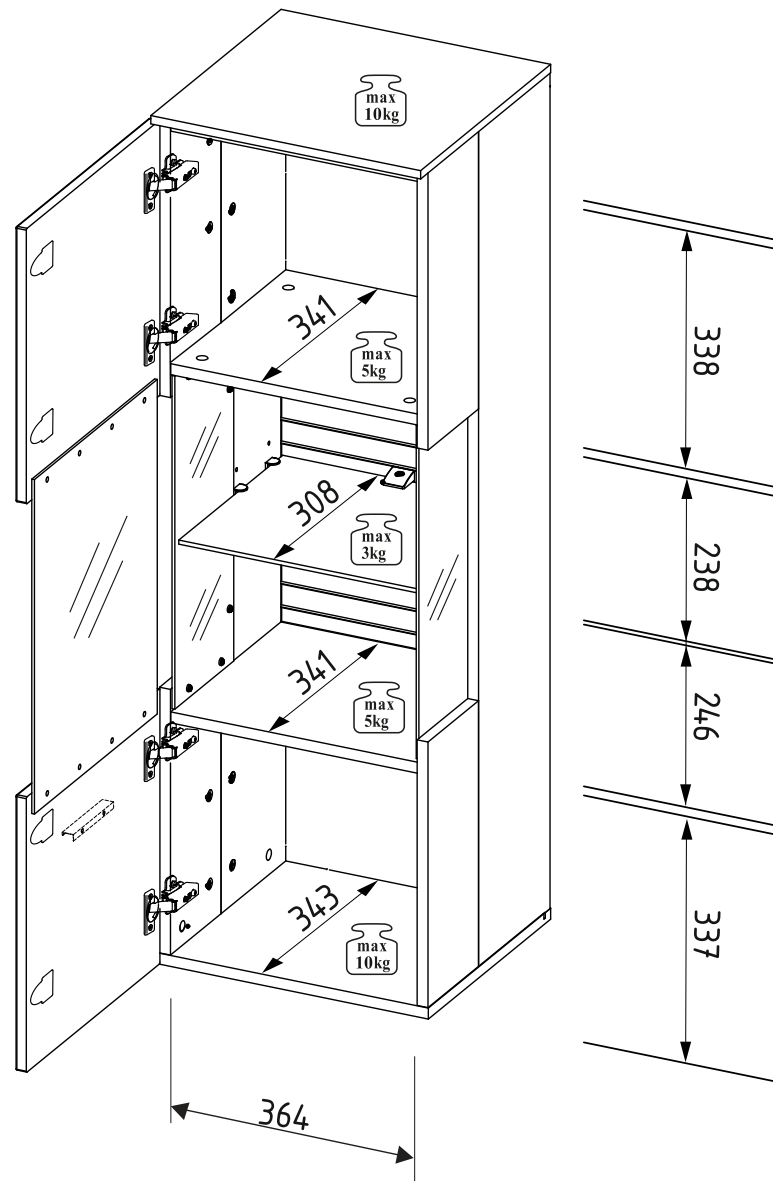

SOK-OSW-026-1

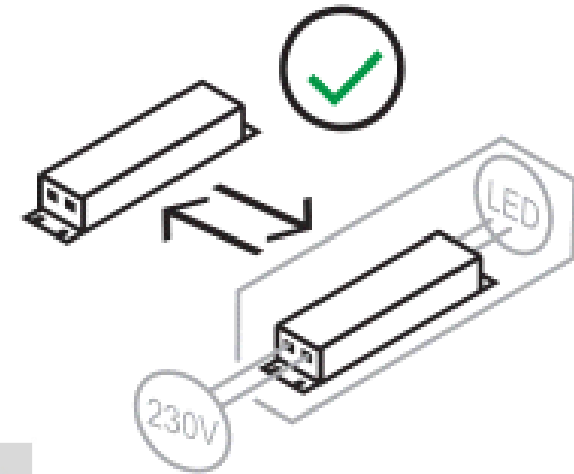
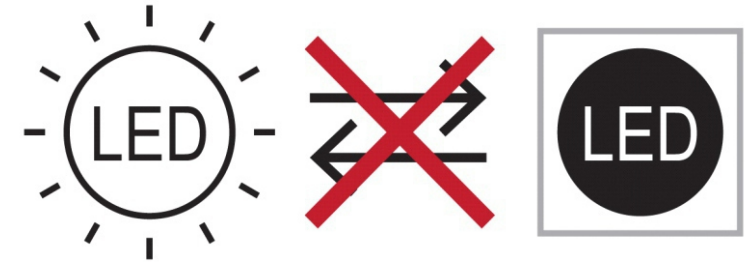
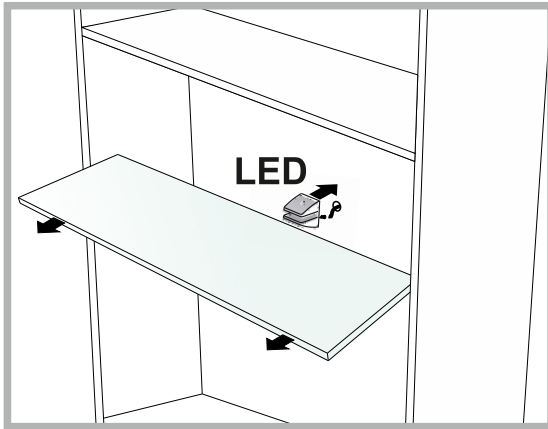

PL- Produkty te zawierają źródła światła, które ze względu na swoje właściwości nie podlegają rozporządzeniu (UE) 2019/2015	DE- Diese Produkte enthalten Lichtquellen, die aufgrund ihrer Eigenschaften nicht unter die Verordnung (EU) 2019/2015 fallen	CS- Tyto výrobky obsahují světelné zdroje, které vzhledem ke svým vlastnostem nespadají do oblasti působnosti nařízení (EU) 2019/2015
DA- Disse produkter indeholder lyskilder, som på grund af deres egenskaber er uden for anvendelsesområdet for forordning (EU) 2019/2015	EL- Αυτά τα προϊόντα περιέχουν πηγές φωτός οι οποίες, λόγω των ιδιοτήτων τους, δεν εμπίπτουν στο πεδίο εφαρμογής του κανονισμού (UE) 2019/2015	EN- These products contain light sources which, due to their properties, are out of the scope of Regulation (EU) 2019/2015
ES- Estos productos contienen fuentes de luz que, por sus propiedades, quedan fuera del ámbito de aplicación del Reglamento (UE) 2019/2015.	ET- Need tooted sisaldavad valgusallikaid, mis oma omaduste tõttu jäävad määruse (UE) 2019/2015 reguleerimisalast välja	FI- Nämä tuotteet sisältävät valonlähteitä, jotka ominaisuuksiensa vuoksi eivät kuulu asetuksen (EU) 2019/2015 soveltamisalaan
FR- Ces produits contiennent des sources lumineuses qui, en raison de leurs propriétés, n'entrent pas dans le champ d'application du règlement (UE) 2019/2015	HU- Ezek a termékek olyan fényforrásokot tartalmaznak, amelyek tulajdonságaik miatt nem tartoznak az (EU) 2019/2015 rendelet hatálya alá	IT- Questi prodotti contengono sorgenti luminose che, per le loro proprietà, esulano dal campo di applicazione del Regolamento (UE) 2019/2015
LT- Šiuose gaminių yra šviesos šaltiniai, kurie dėl savo savybių nepatenka į Reglamento (UE) 2019/2015 taikymo sritį	LV- Šie produkti satur gaismas avotus, kas to īpašību dēļ ir ārpus Regulas (UE) 2019/2015 darbības jomas	RU- Эти продукты содержат источники света, которые из-за своих свойств не подпадают под действие Регламента (ЕС) 2019/2015.
PT- Estes produtos contêm fontes de luz que, devido às suas propriedades, estão fora do âmbito do Regulamento (UE) 2019/2015	RO- Aceste produse conțin surse de lumină care, datorită proprietăților lor, nu intră în domeniul de aplicare al Regulamentului (UE) 2019/2015	NL- Deze producten bevatten lichtbronnen die vanwege hun eigenschappen buiten het toepassingsgebied van Verordening (EU) 2019/2015 vallen
SK- Tieto výrobky obsahujú svetelné zdroje, ktoré vzhľadom na svoje vlastnosti nepatria do rozsahu pôsobnosti nariadenia (EÚ) 2019/2015	SLO- Ti izdelki vsebujejo svetlobne vire, ki zaradi svojih lastnosti ne spadajo na področje uporabe Uredbe (EU) 2019/2015	SV- Dessa produkter innehåller ljuskällor som på grund av sina egenskaper inte omfattas av förordning (EU) 2019/2015
TR- Bu ürünler, özellikleri nedeniyle (UE) 2019/2015 Yönetmeliğinin kapsamı dışında kalan ışık kaynakları içerir.	HR- Ovi proizvodi sadrže izvore svjetlosti koji zbog svojih svojstava nisu obuhvaćeni Uredbom (EU) 2019/2015	BG- Тези продукти съдържат източници на светлина, които поради своите свойства са извън обхвата на Регламент (ЕС) 2019/2015