

Nr				pcs	
1	1207	418	16	1	3
2	1207	418	16	1	3
3	1232	398	16	1	1
4	1266	418	16	1	3
5	709	397	16	1	2
6	1191	398	16	1	2
7	738	418	16	2	2
8	738	418	16	1	2
9	418	246	16	1	1
10	418	246	16	1	1
11	350	140	12	4	1
12	350	140	12	4	1
13	357	140	12	3	1
14	367	348	2	3	1
15	397	388	16	2	1
16	819	398	16	1	2
17	410	1214	2	1	3
18	420	1214	2	1	3
19	1266	440	12	1	3
20	232	150	16	1	1
21	418	225	16	1	1
22	418	246	16	1	1
23	366	140	12	1	1
24	376	348	2	1	1
25	410	1214	2	1	3
26	406	388	16	1	1
27	218	397	16	1	1
28	819	398	16	1	2

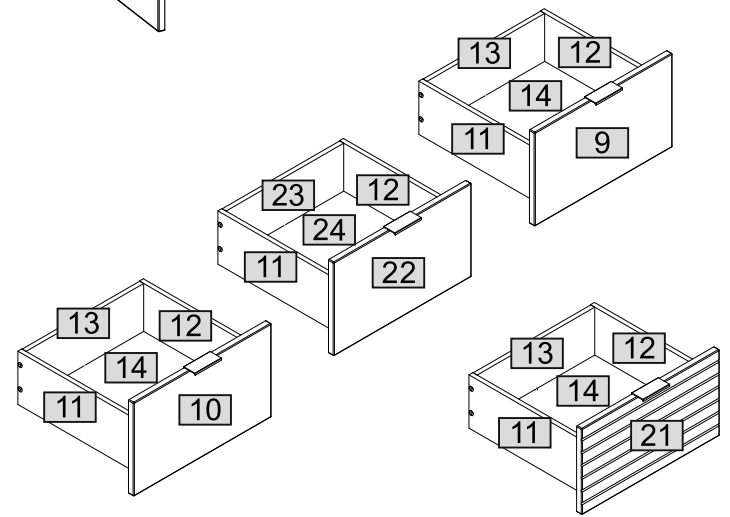

4

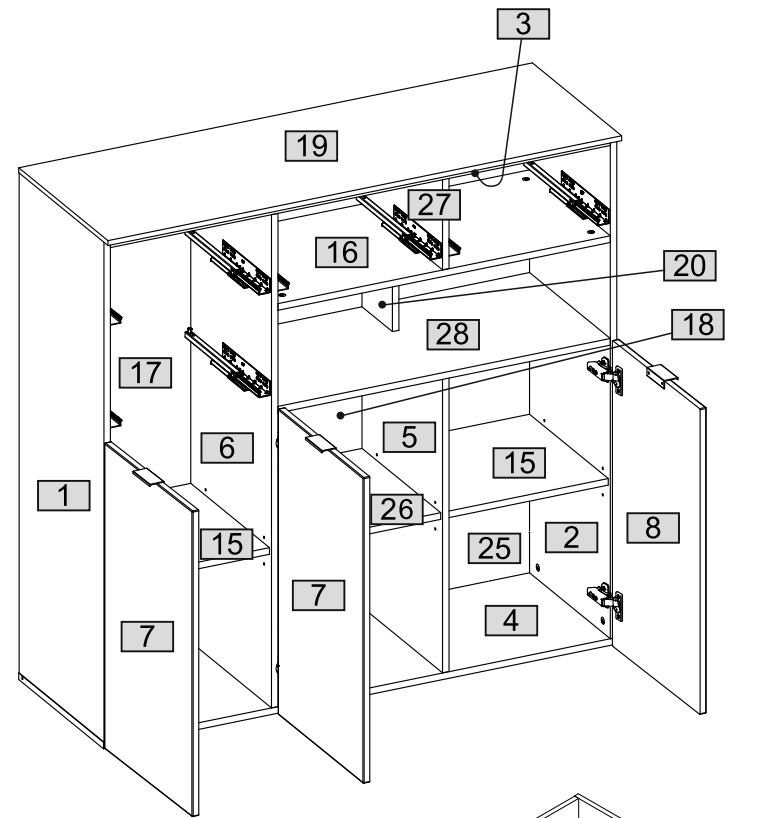
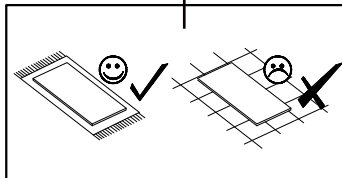
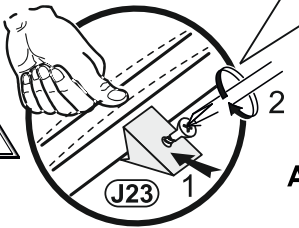
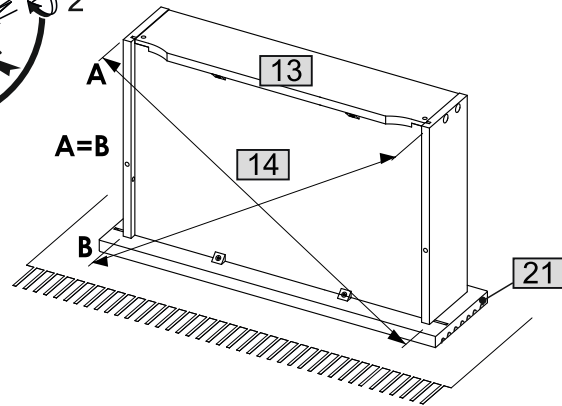
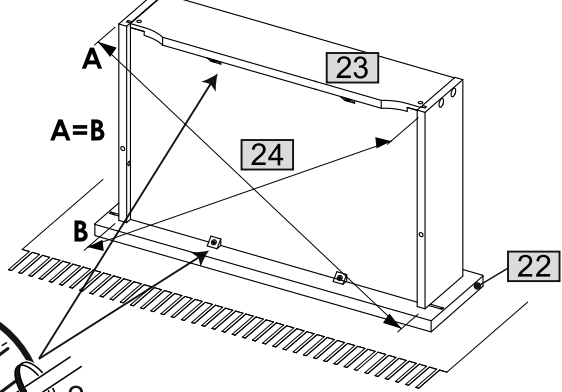
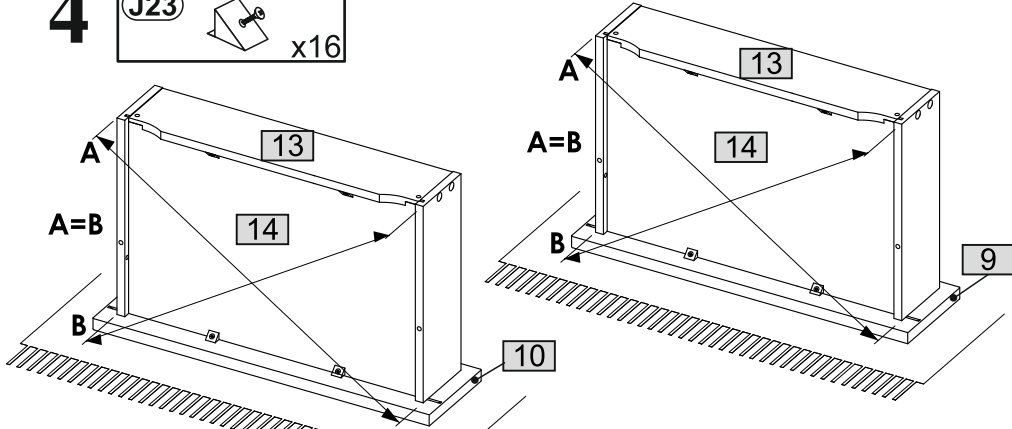
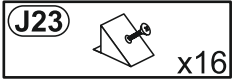

5

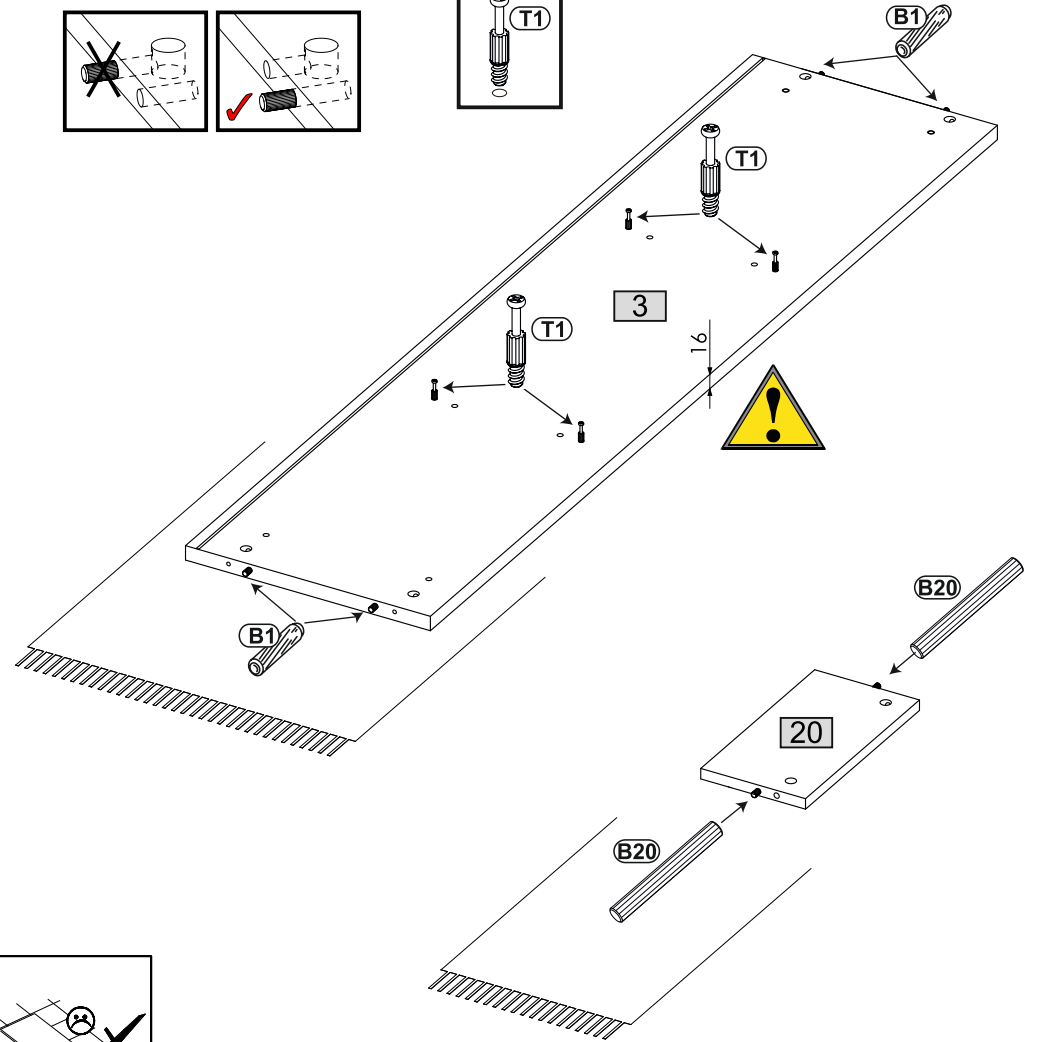
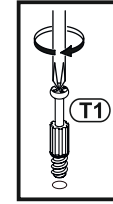
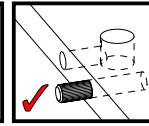
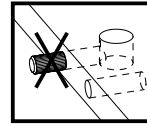
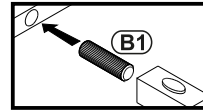
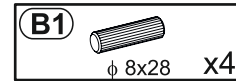
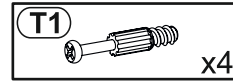
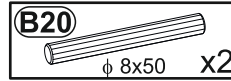

6

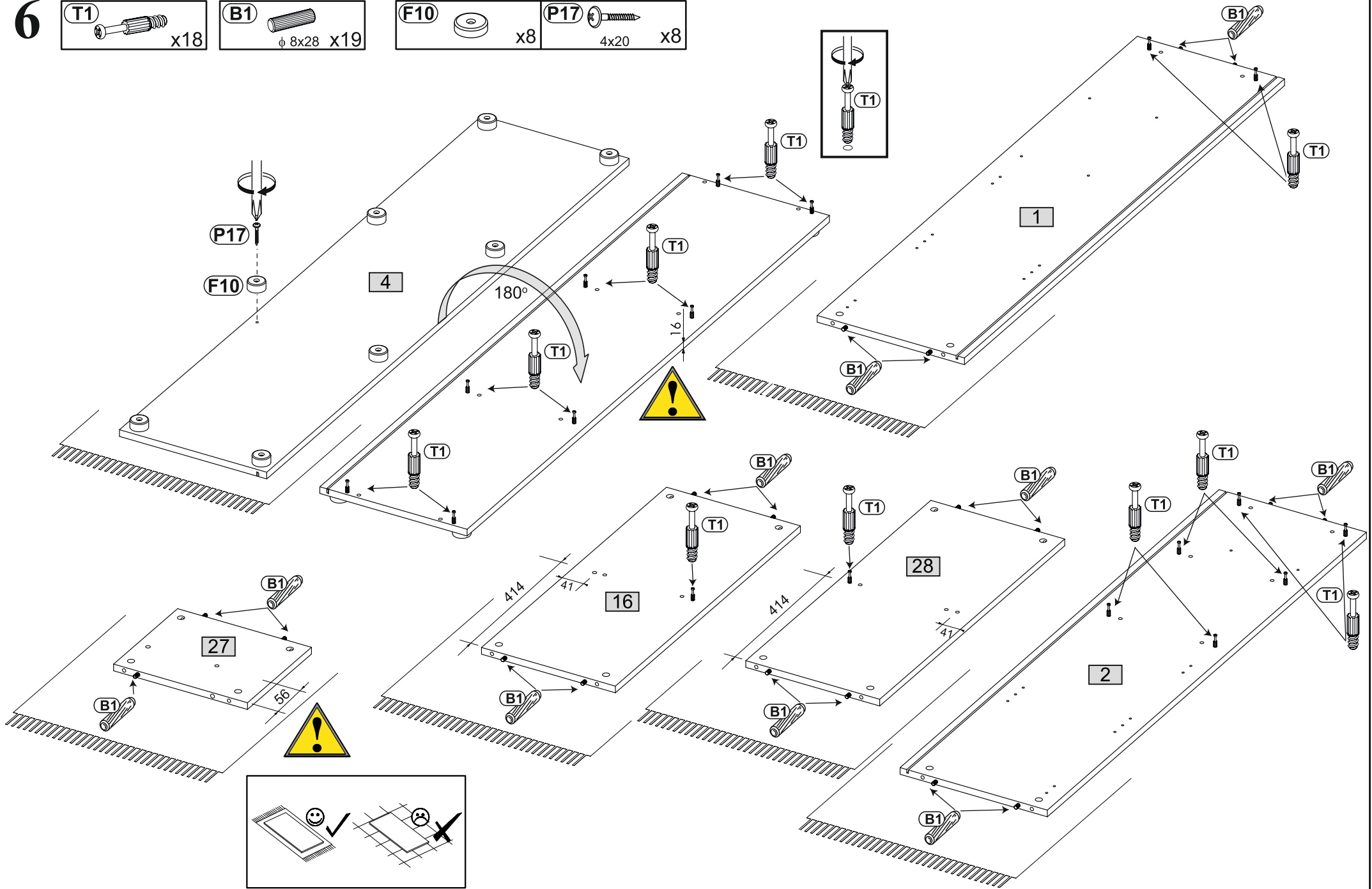
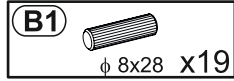
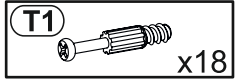

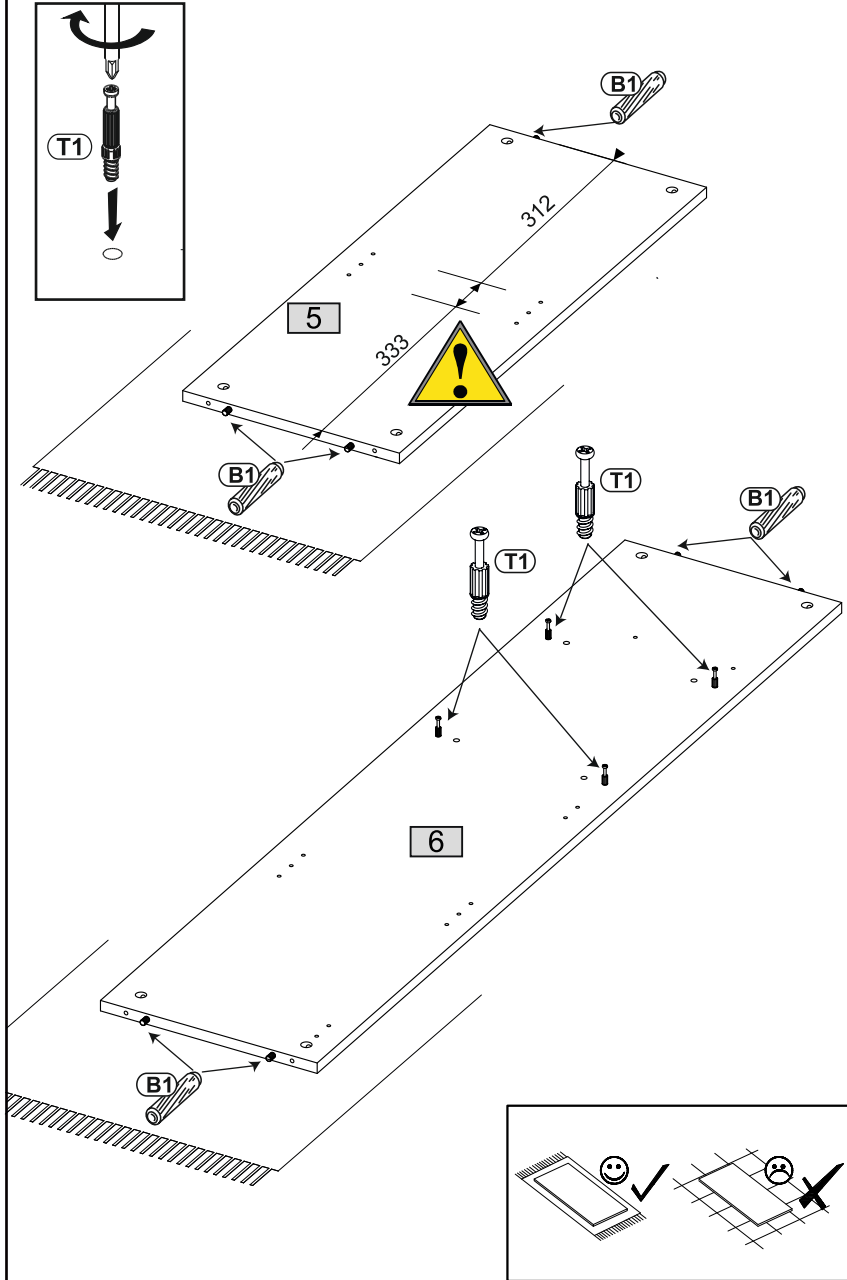
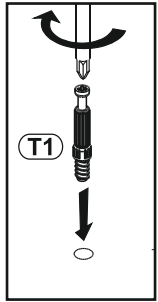
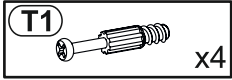
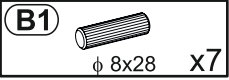

7

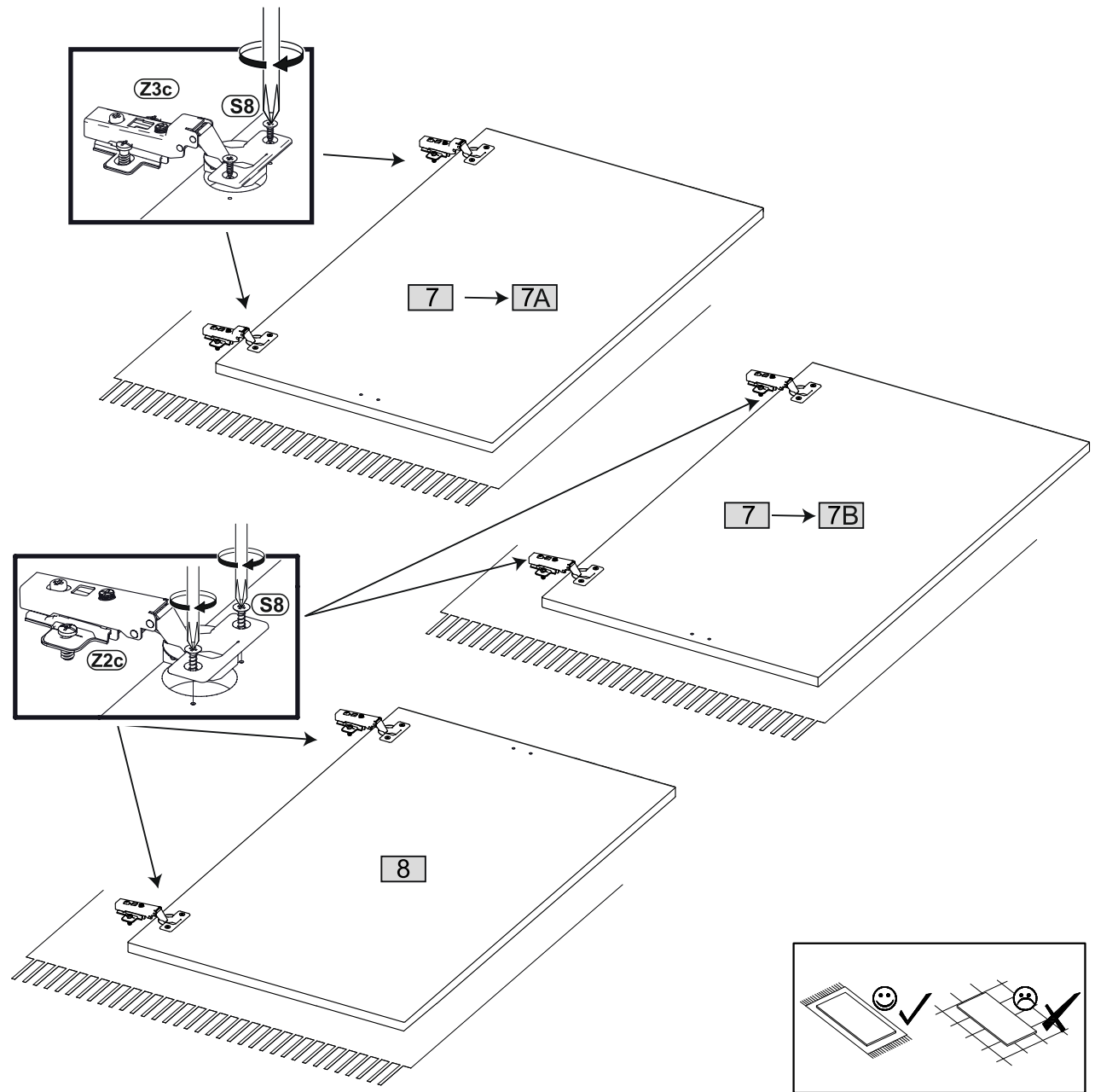
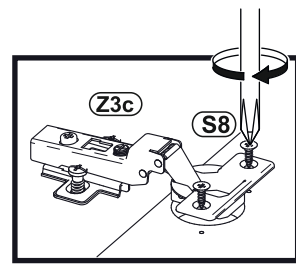
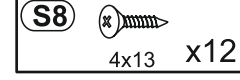
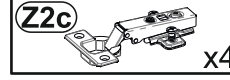
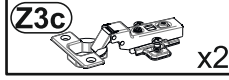

8

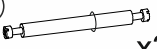

9

- T3  x2
- M1  φ15x12 x6

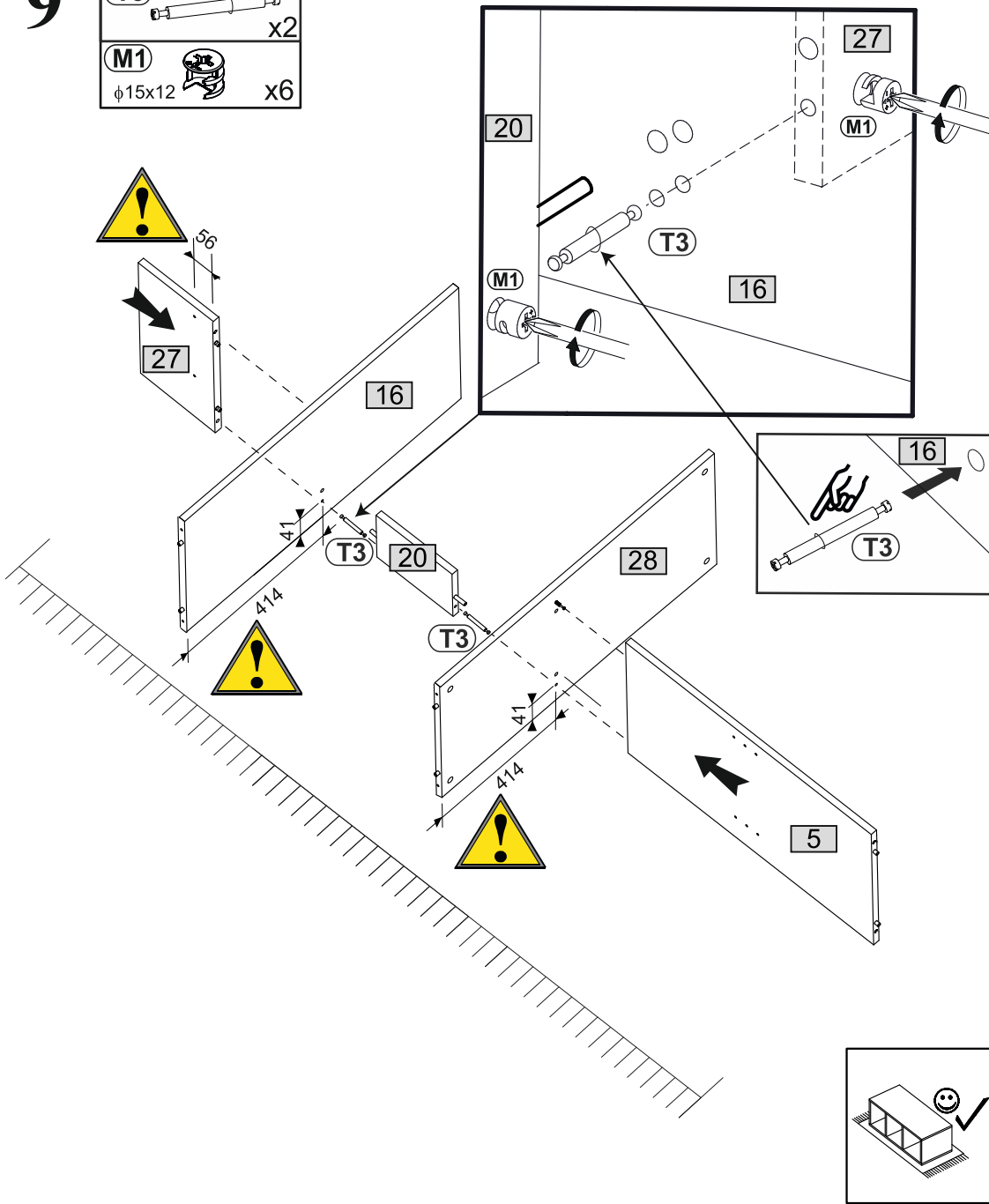

10

- M1  φ15x12 x4

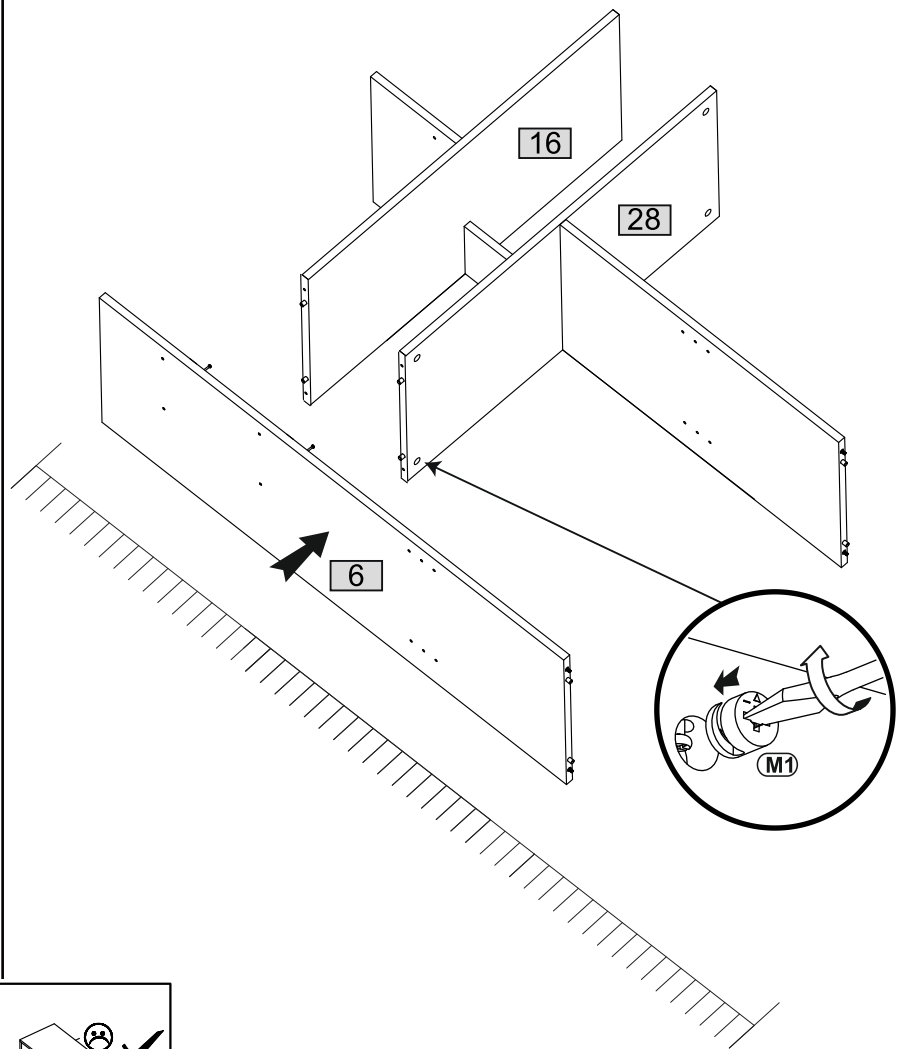

11

M1
φ15x12 x4

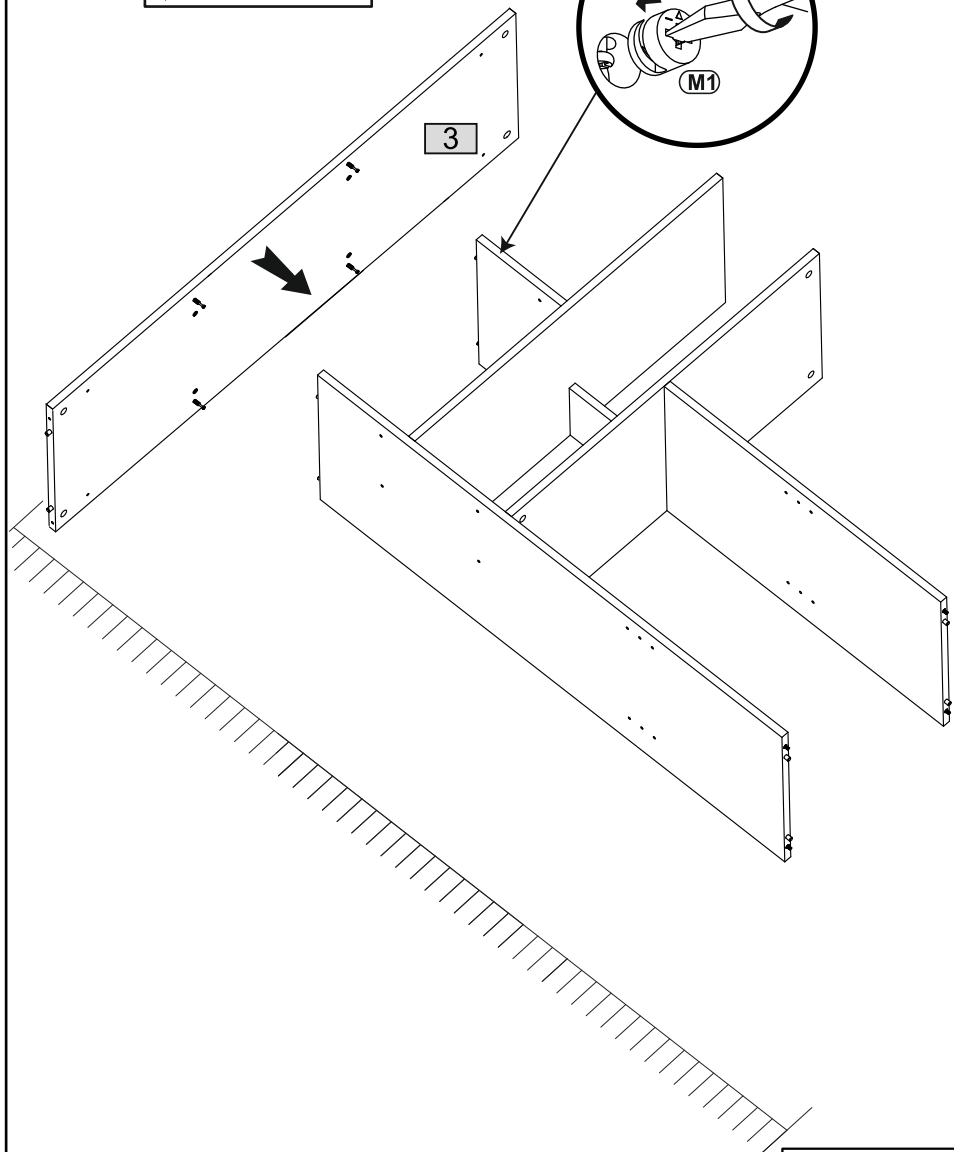
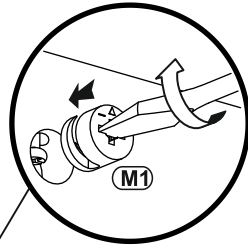

12

M1
φ15x12 x8

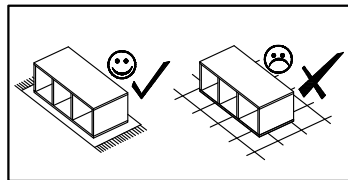
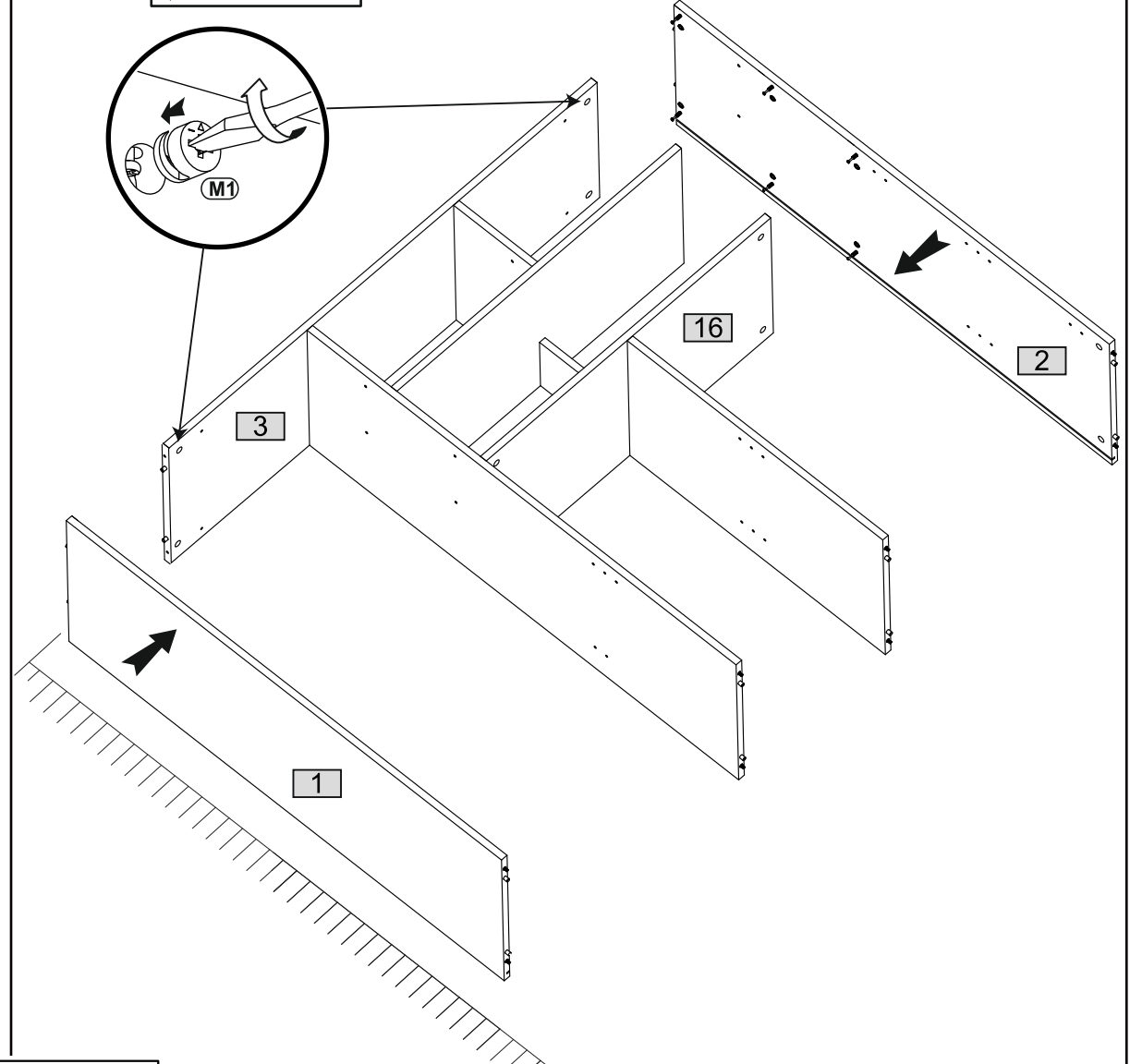
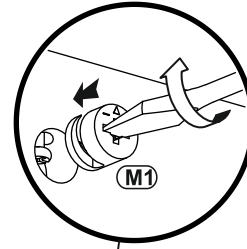

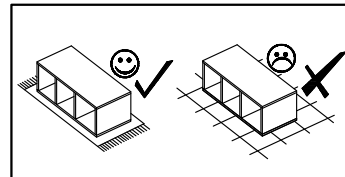
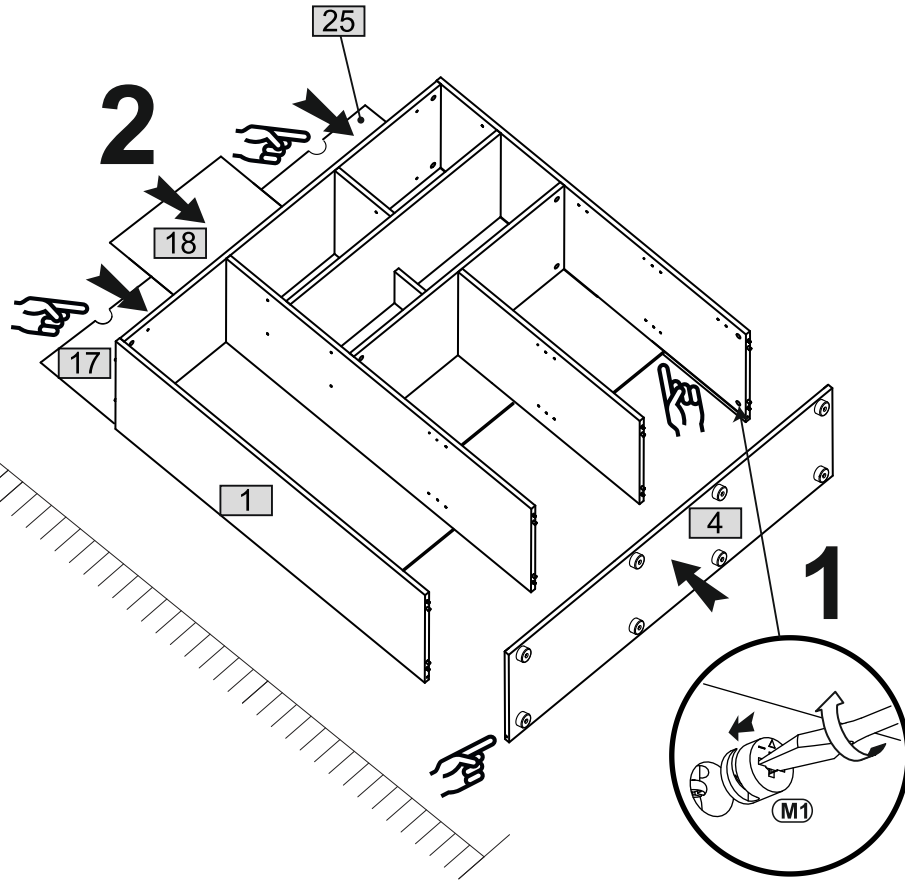
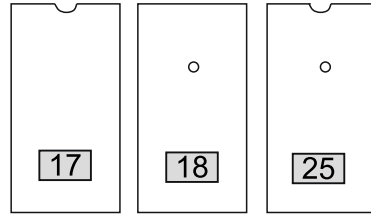

13

M1  x8



14

J23  x18

F1  x12

P2  3x16 x22

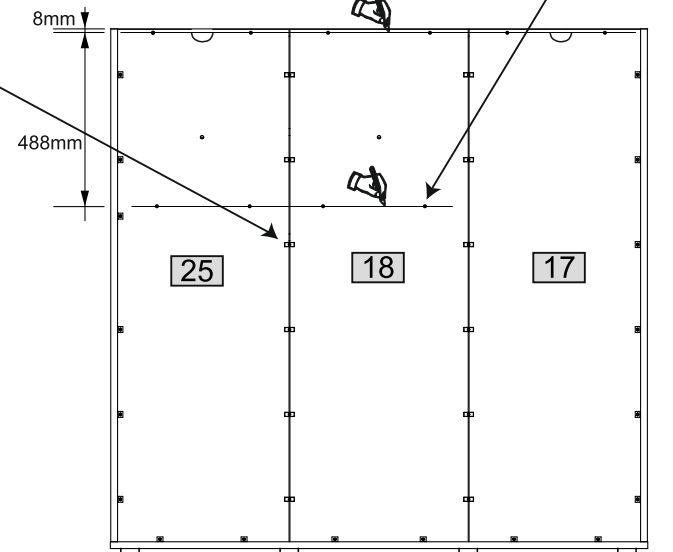
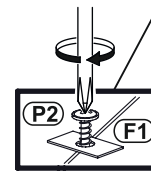
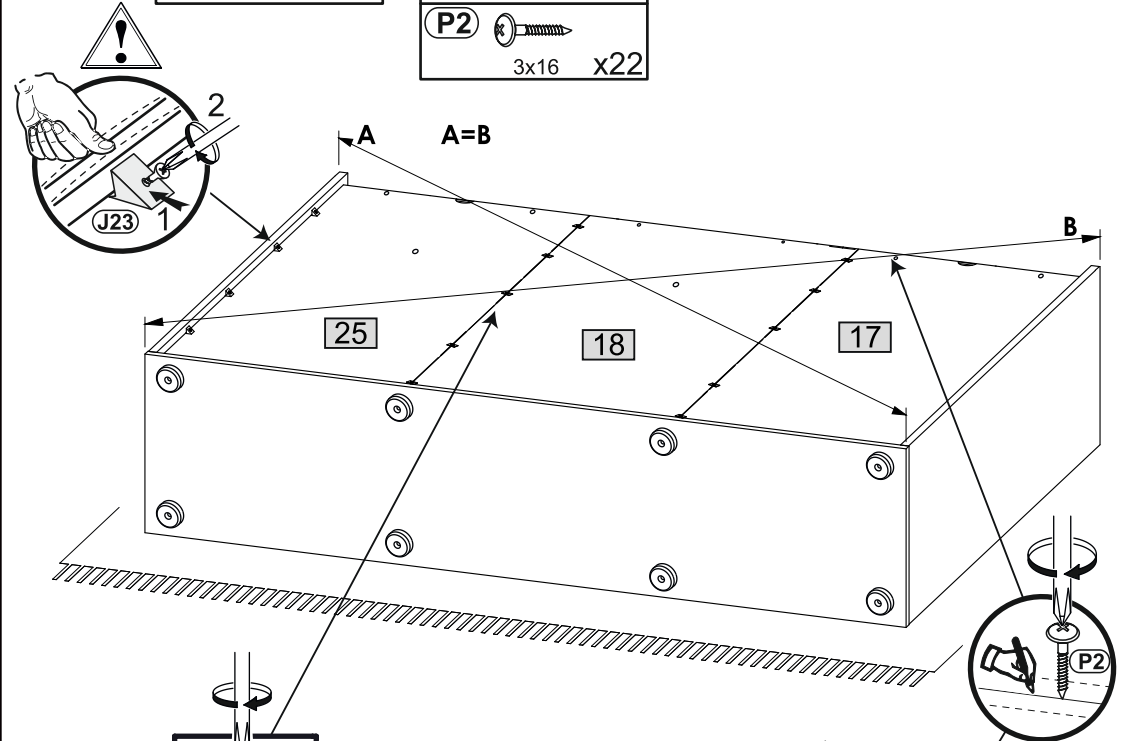

15

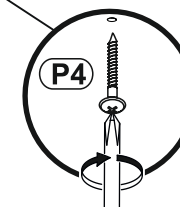
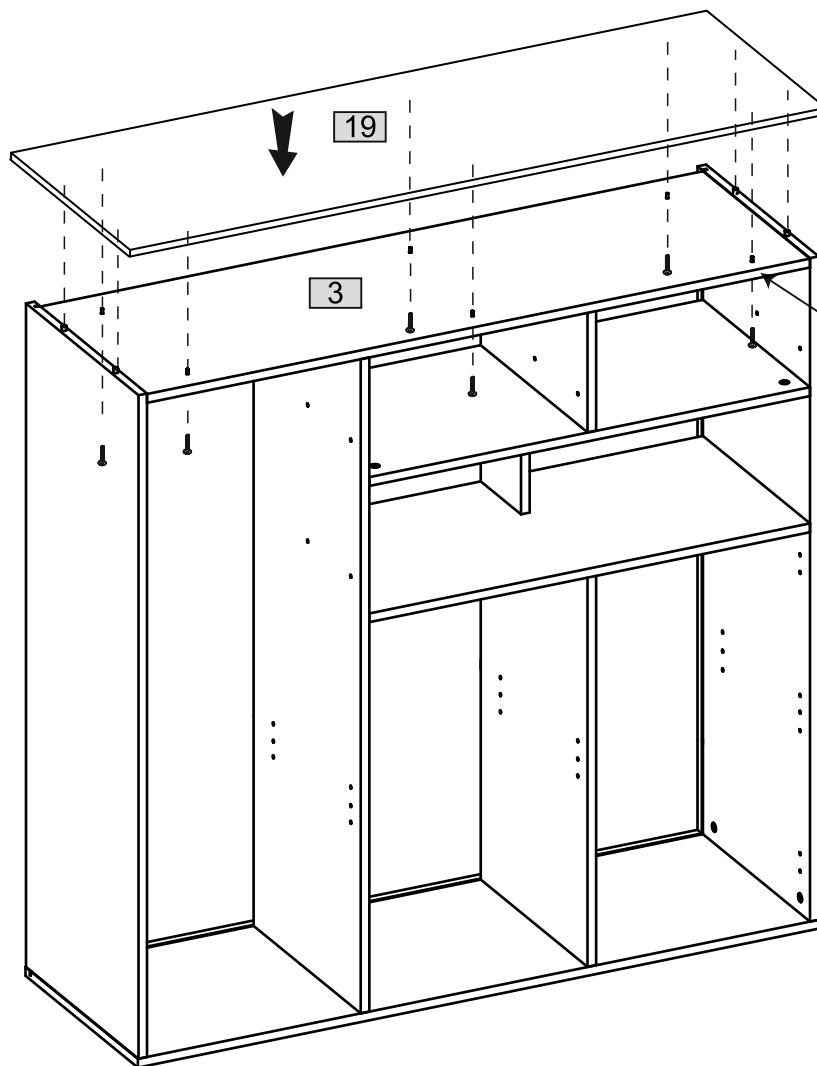
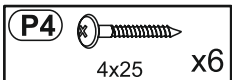

16

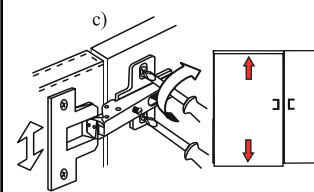
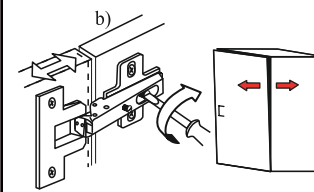
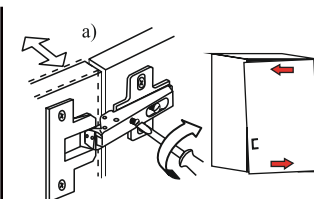
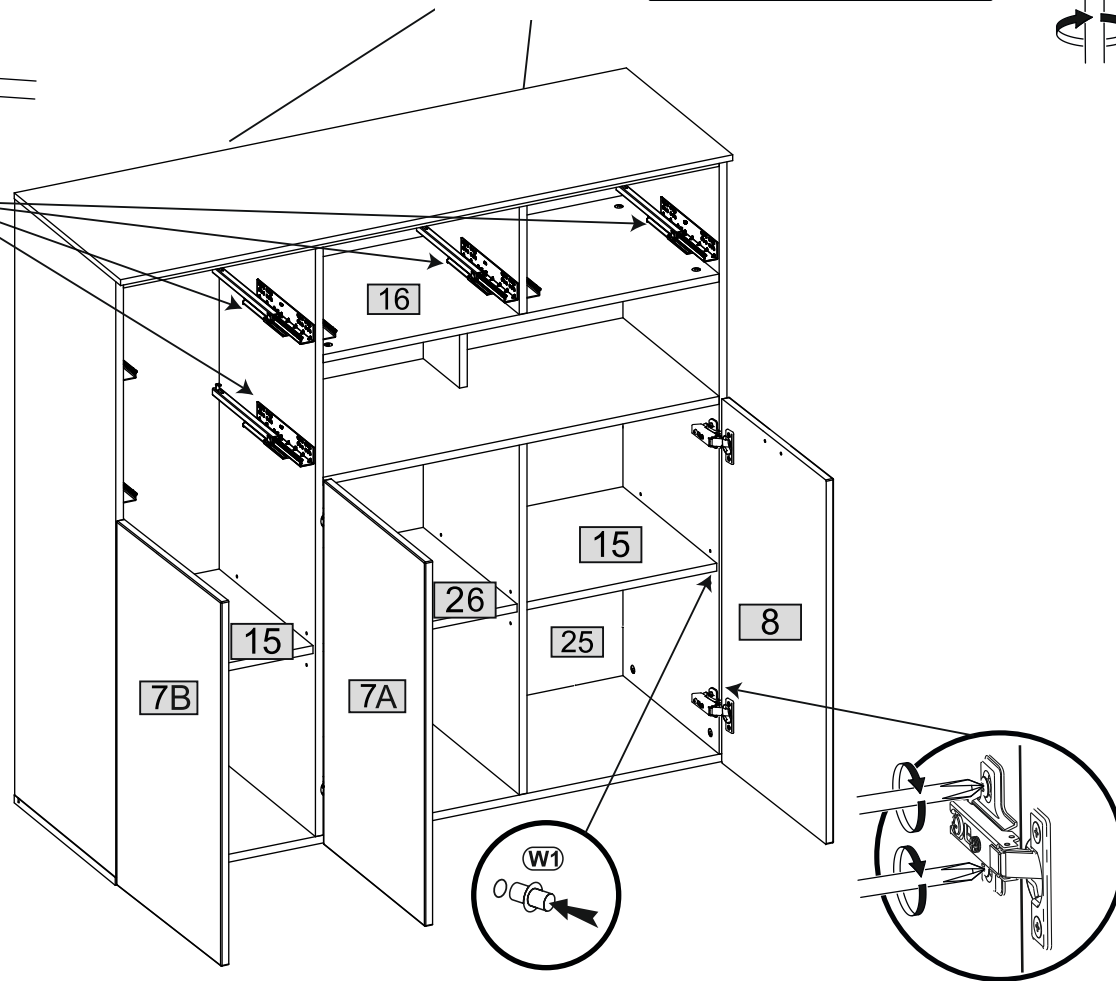
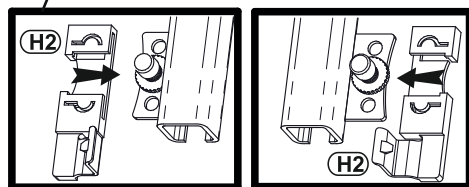
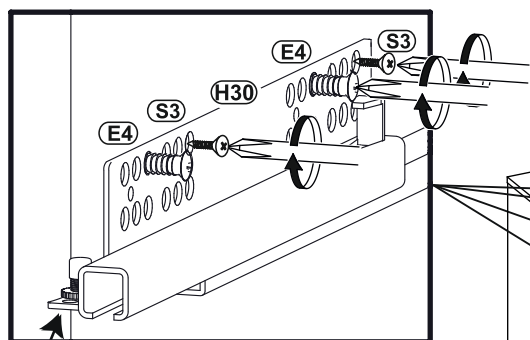
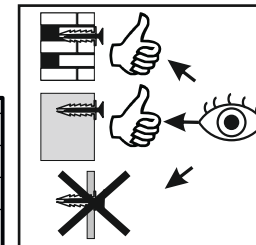
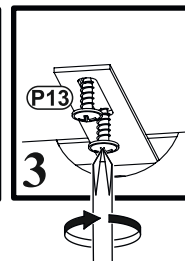
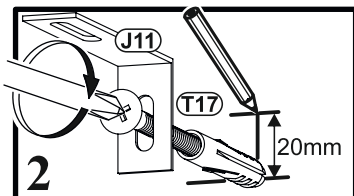
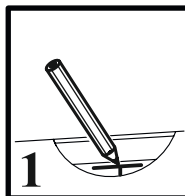
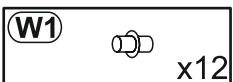
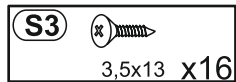
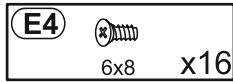
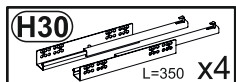
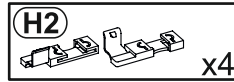
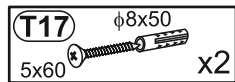
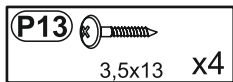
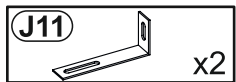

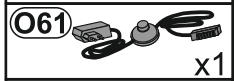

17

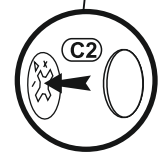
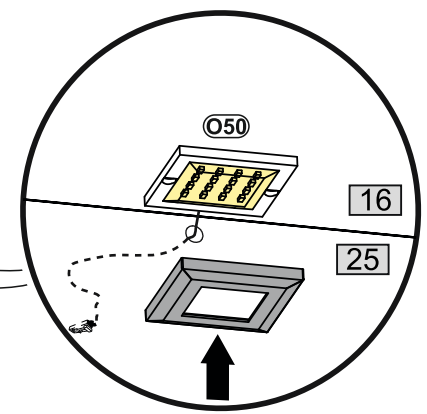
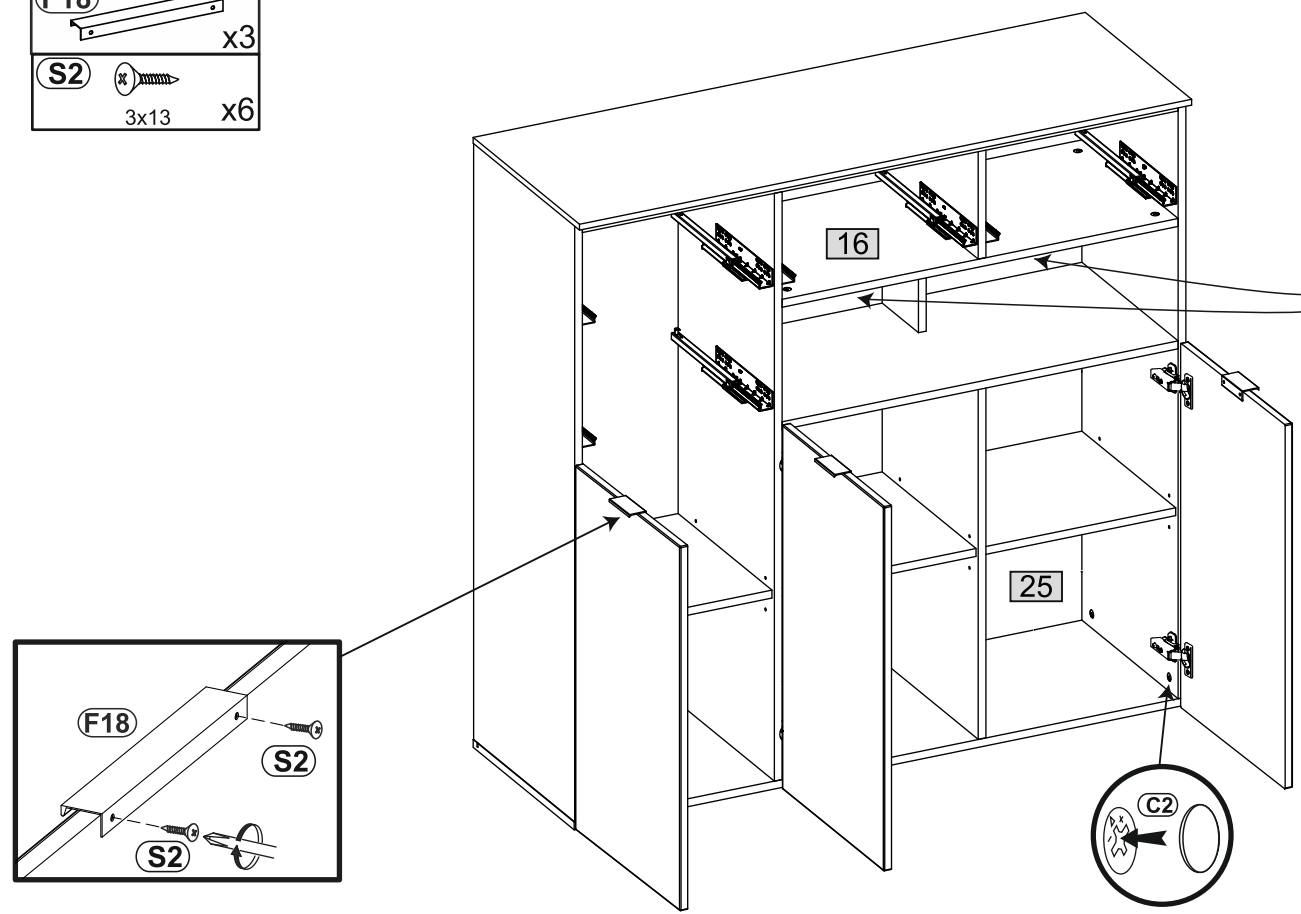
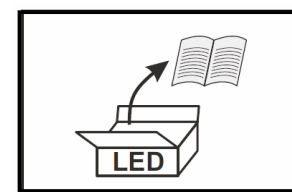
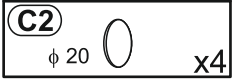
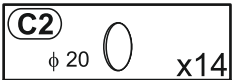
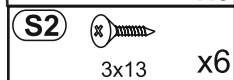
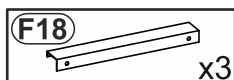

SOK-OSW-
-001-030-2-NW



18

- F18**  x4
- S2**  3x13 x8
- L6**  x7

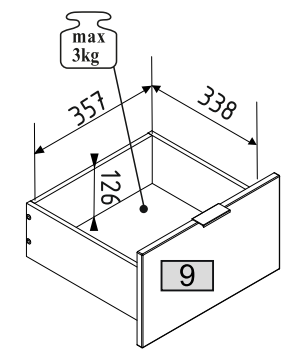
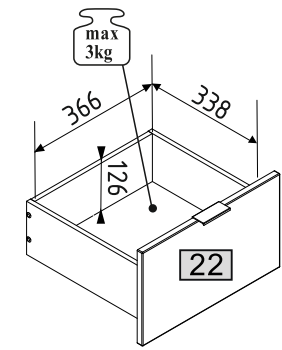
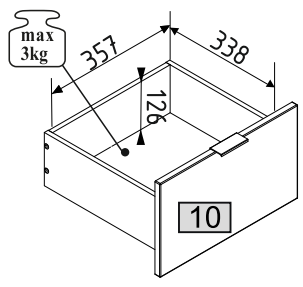
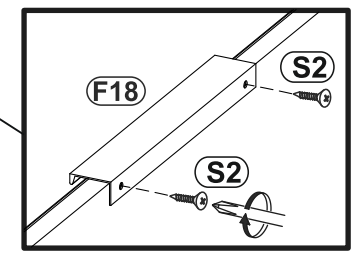
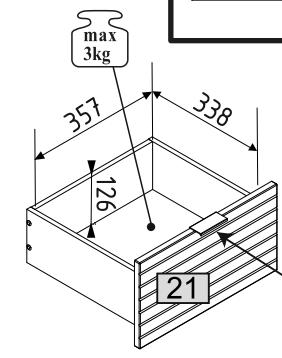
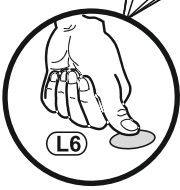
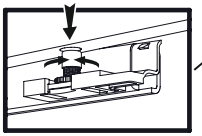
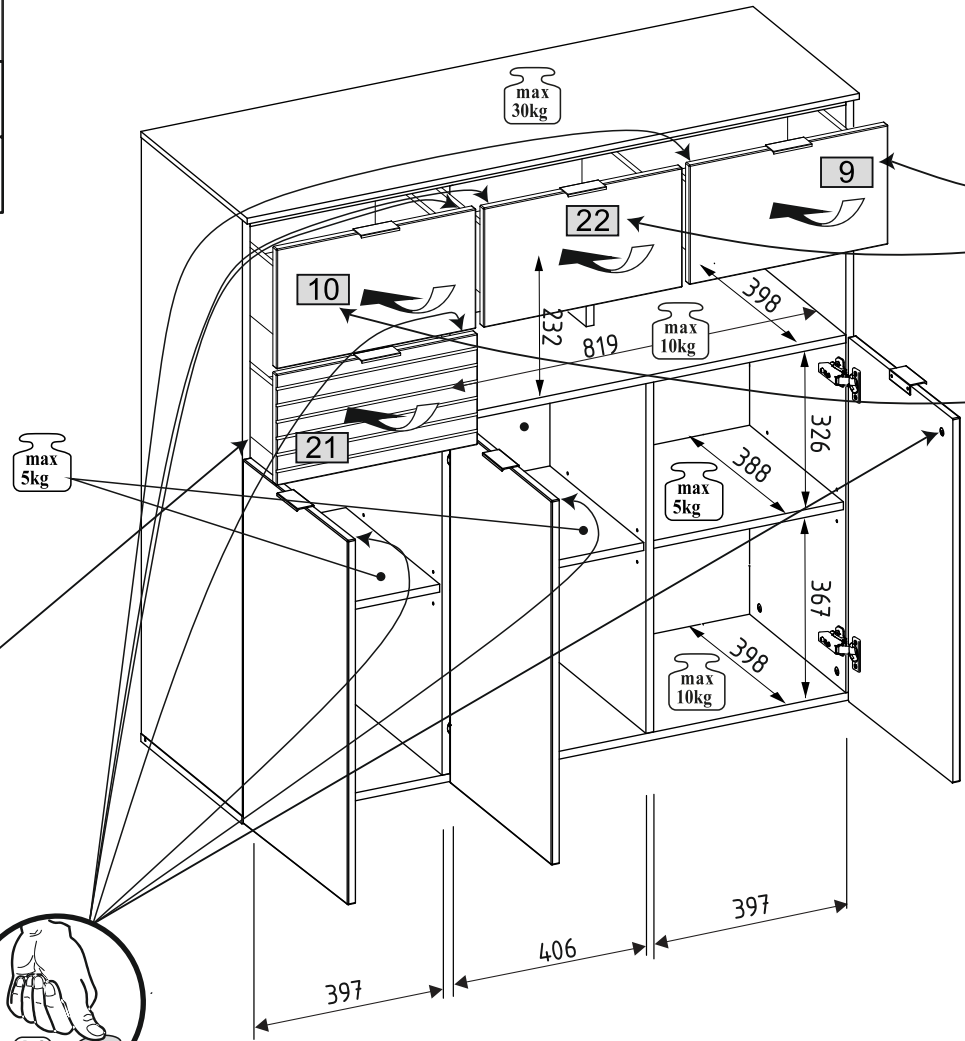
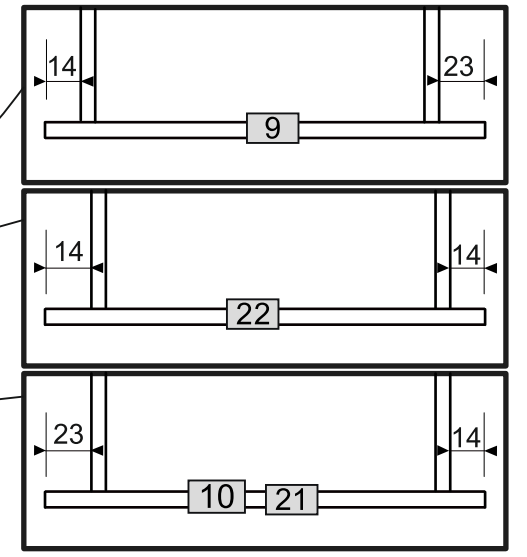

787850 SQUERE 2S-PCB-NW

SOK-OSW-001-030-2-NW

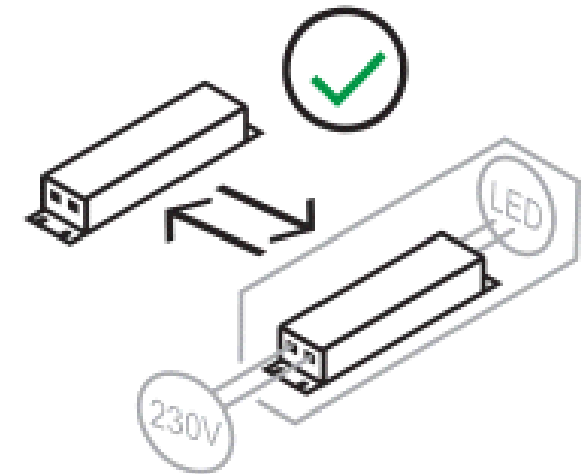
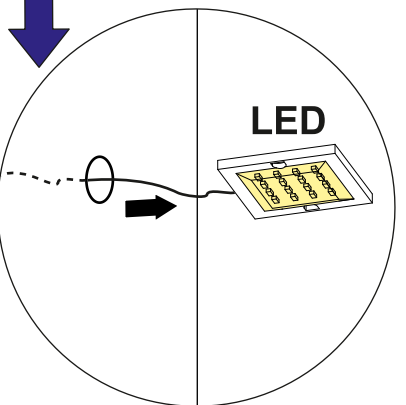
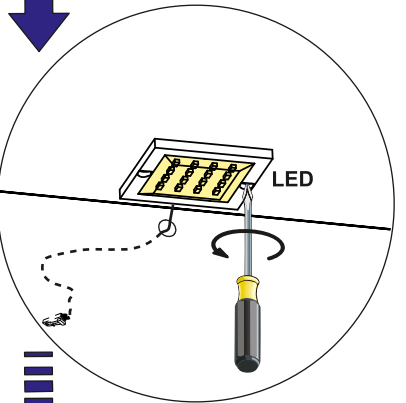
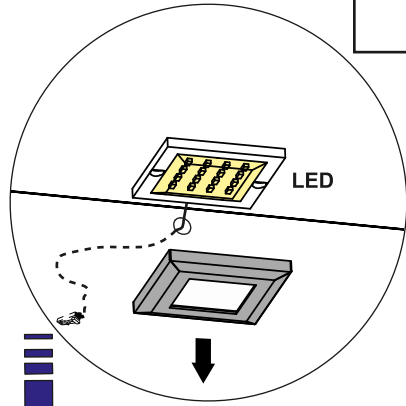
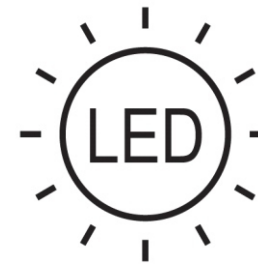

PL- Ten produkt zawiera źródła światła o klasie efektywności energetycznej „F”

DA- Dette produkt indeholder en lyskilde til energieffektivitetsklasse „F”

ES- Este producto contiene una fuente de luz de clase de eficiencia energética „F”

FR- Ce produit contient des sources lumineuses de classe d'efficacité „F”

LT- Šiame gaminyje yra energijos vartojimo efektyvumo klasės šviesos šaltinis „F”

PT- Este produto contém uma fonte de luz da classe de eficiência energética „F”

SK- Tento výrobok obsahuje svetelný zdroj triedy energetickej účinnosti „F”

TR- Bu ürün bir ışık kaynağı enerji verimliliği sınıfı içerir „F”

DE- Diese Produkte enthalten Lichtquellen der Energieeffizienzklasse „F”

EL- Αυτό το προϊόν περιέχει μια πηγή φωτεινής πηγής ενεργειακής απόδοσης „F”

ET- See toode sisaldab efektiivsusklassi valgusallikat energia „F”

HU- Ez a termék energiahatékonysági osztályú fényforrást tartalmaz „F”

LV- Šis produkts satur gaismas avotu ar energoefektivitātes klasi „F”

RO- Acest produs conține o sursă de lumină de clasă de eficiență energetică „F”

SLO- Ta izdelek vsebuje svetlobni vir razreda energijske učinkovitosti „F”

HR- Ovaj proizvod sadrži izvor svjetlosti razreda energetske učinkovitosti „F”

CS- Tento výrobek obsahuje světelný zdroj třídy energetické účinnosti „F”

EN- This product contains a light sources of energy efficiency class „F”

FI- Tämä tuote sisältää energiatehokkuusluokan valonlähteen „F”

IT- Questo prodotto contiene una sorgente luminosa di classe di efficienza energetica „F”

RU- Этот продукт содержит источник света класса энергоэффективности „F”

NL- Dit product bevat een lichtbron met energie-efficiëntieklasse „F”

SV- Denna produkt innehåller en ljuskälla för energieffektivitetsklass „F”

BG- Този продукт съдържа източник на светлина от клас на енергийна ефективност „F”