

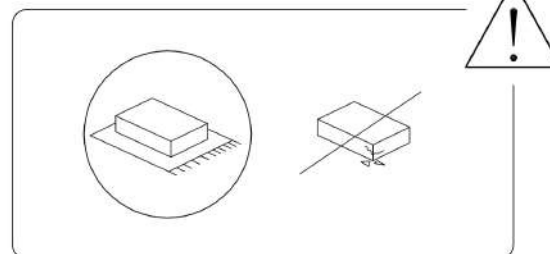

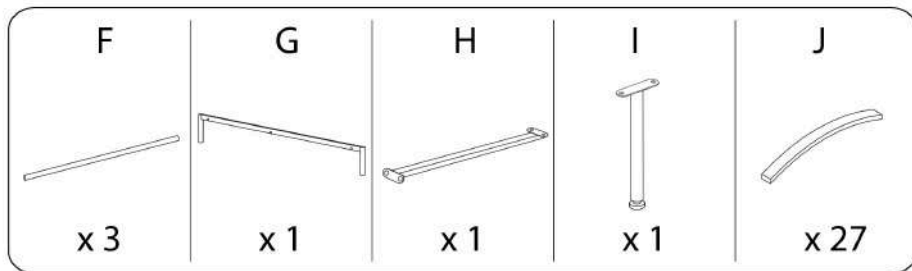

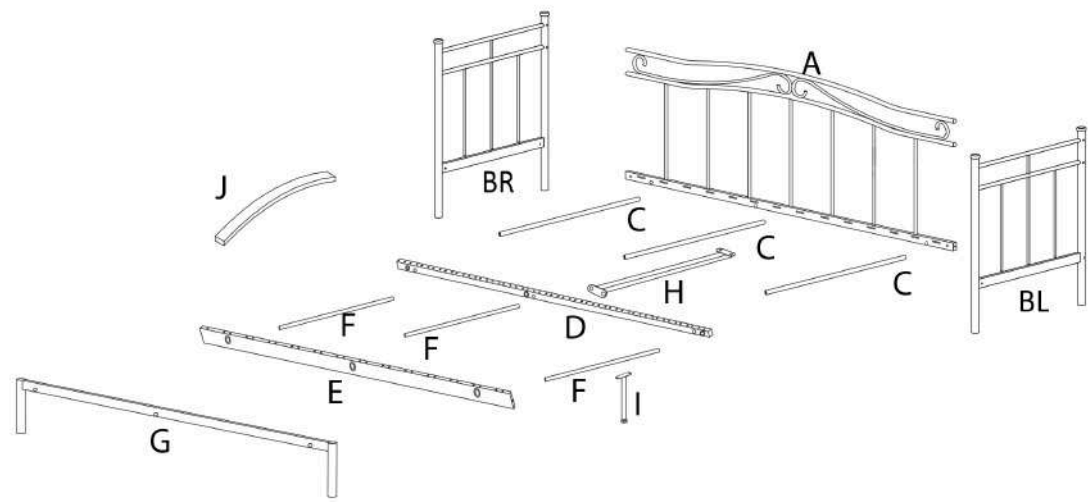

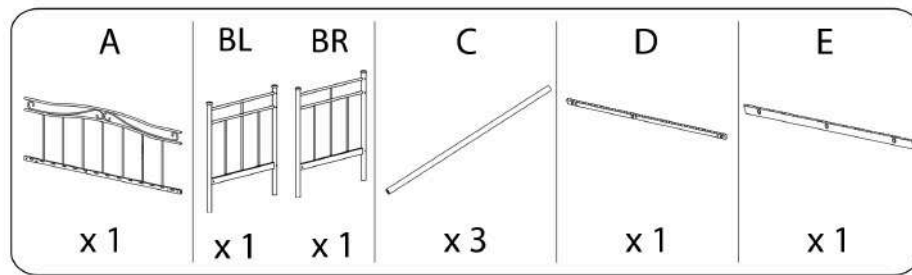



60'

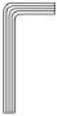

1



<p>K</p>  <p>M8 x 70</p> <p>x 4</p>	<p>L</p>  <p>M6 x 20</p> <p>x 12</p>	<p>M</p>  <p>M6 x 60</p> <p>x 4</p>	<p>N</p>  <p>x 1</p>	<p>O</p>  <p>x 1</p>
<p>P</p>  <p>x 4</p>	<p>Q</p>  <p>x 27</p>	<p>R</p>  <p>x 4</p>	<p>S</p>  <p>x 4</p>	<p>T</p>  <p>8 x 18</p> <p>x 6</p>
<p>U</p>  <p>6 x 18</p> <p>x 6</p>				

1 x2

B



x 1

R



x 2

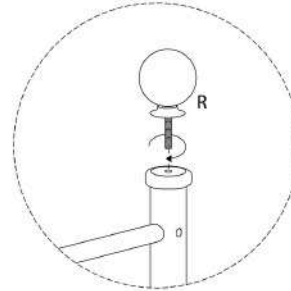
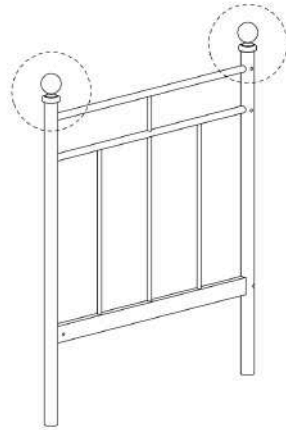

2

A

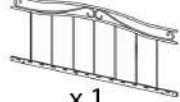

x 1

P

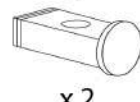

x 2

S



x 4

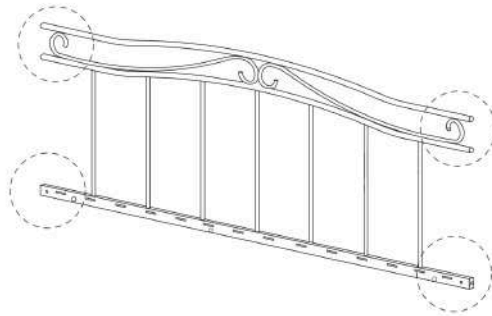

1a

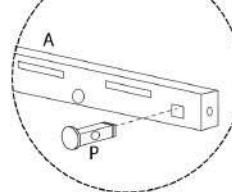

1b

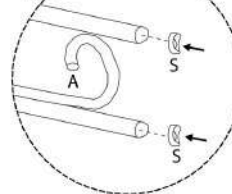

3

<b>K</b> M8 x 70 x2	<b>M</b> M6 x 60 x4	<b>T</b> 8 x 18 x6	<b>N</b> x1	<b>O</b> x1
---------------------------------	---------------------------------	--------------------------------	----------------	----------------

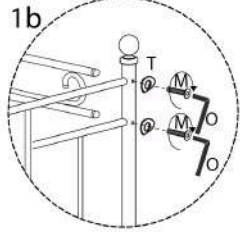
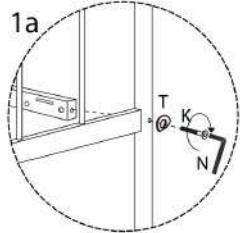
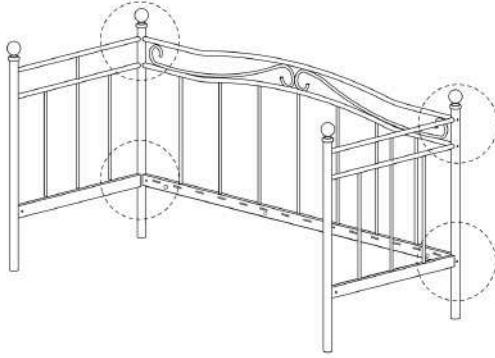

4

<b>C</b> x3	<b>D</b> x1
----------------	----------------

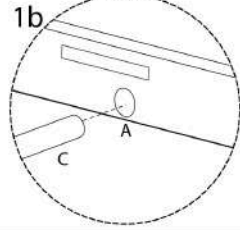
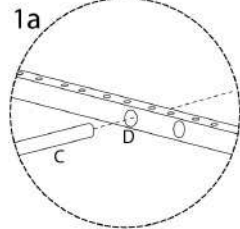
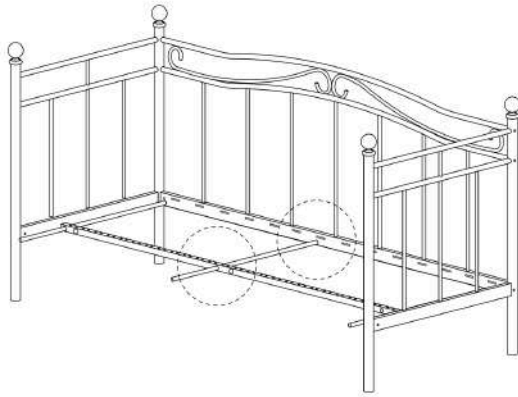

5

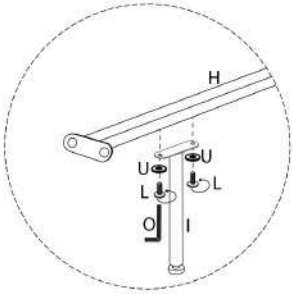
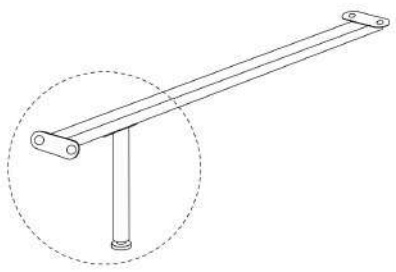
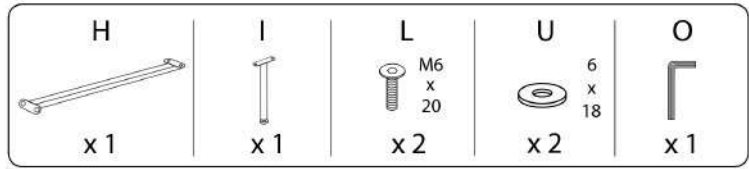

6

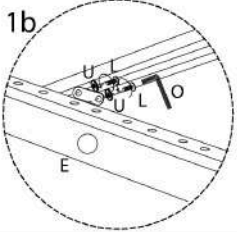
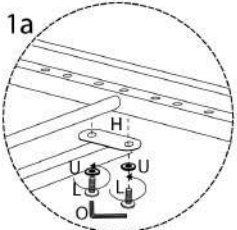
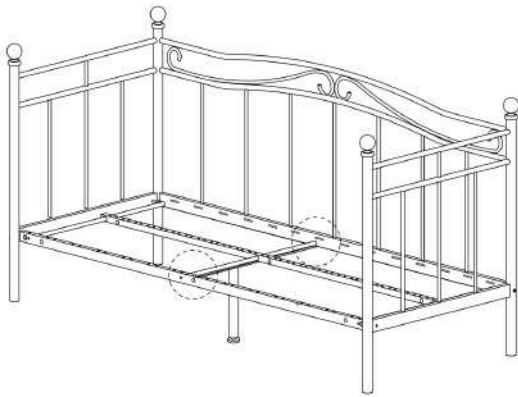
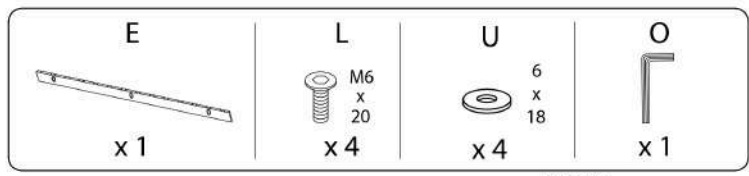

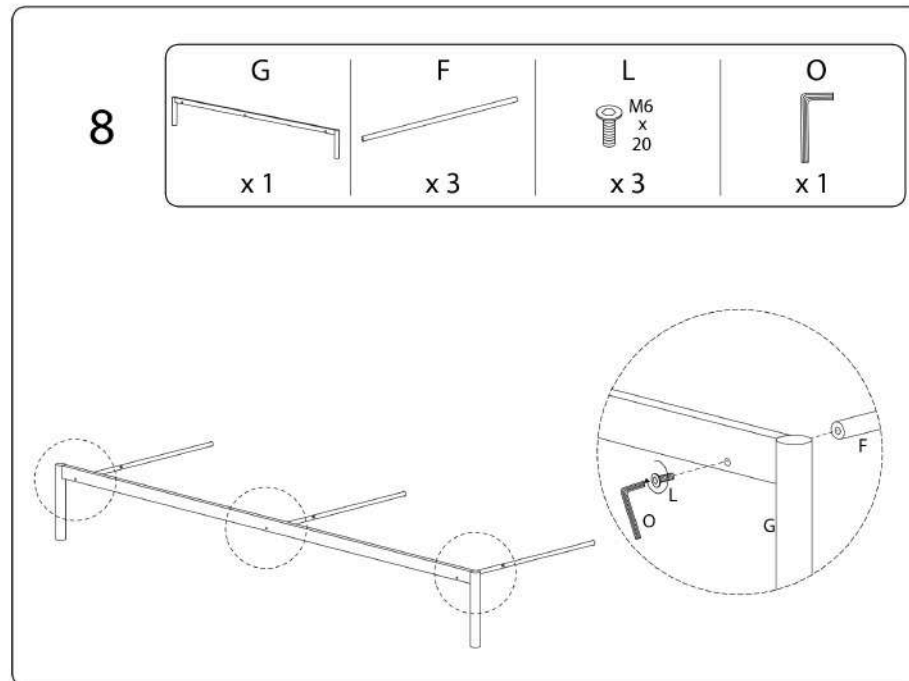
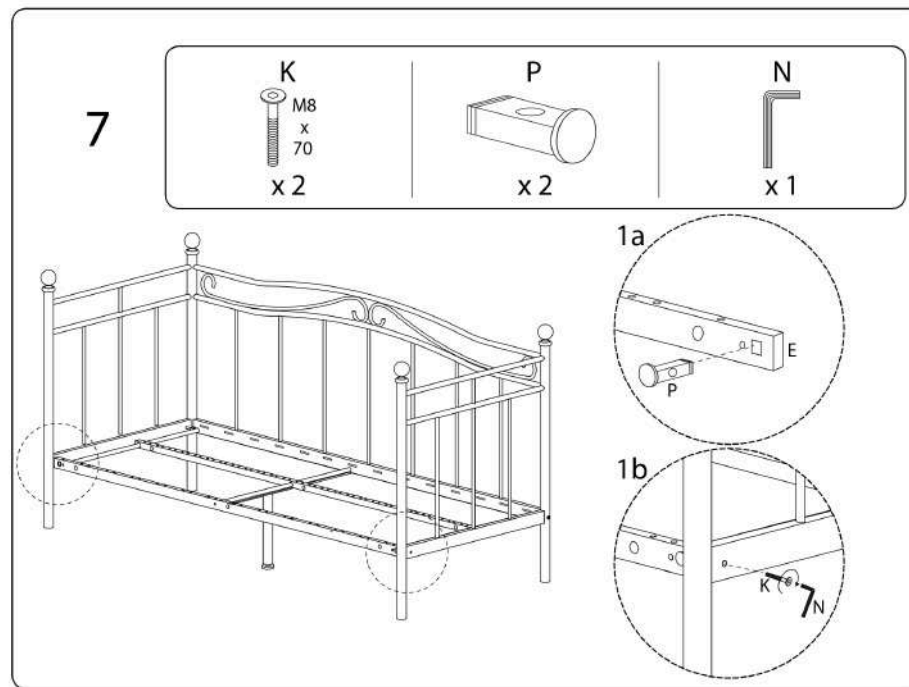

9

L  
M6  
x  
20  
x3



O  
x1

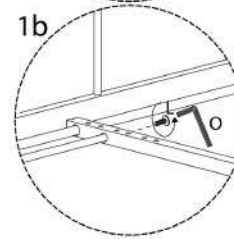
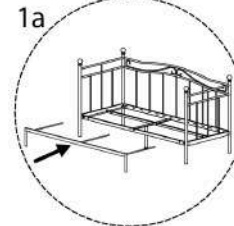
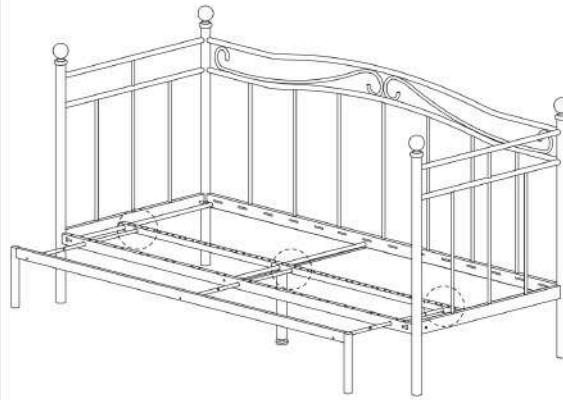

10 x27

J

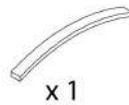

x1

Q

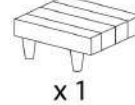

x1

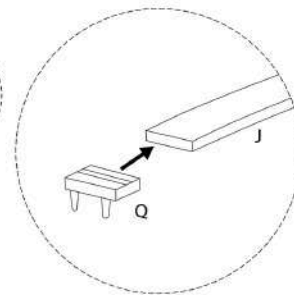
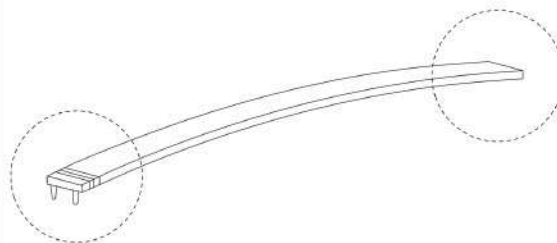

11 x 27

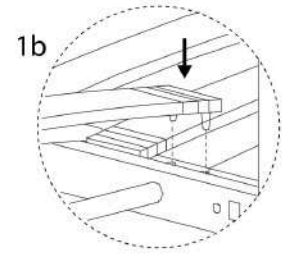
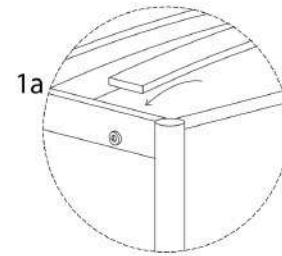

12

