

# Kindu

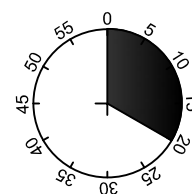

1

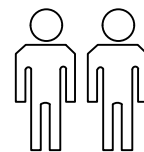
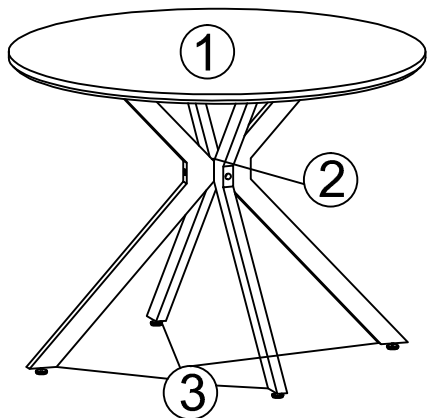
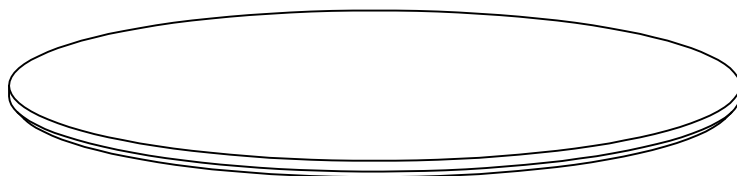

2



3

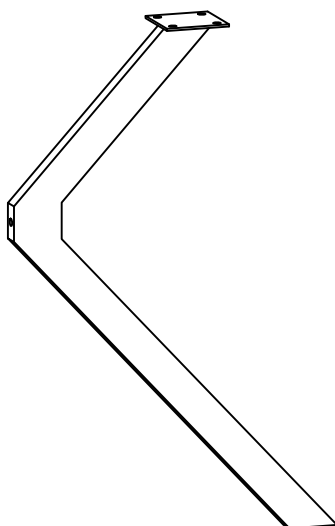

1	1x	1/2
2	1x	2/2
3	4x	2/2





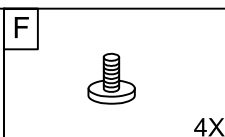
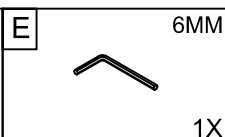
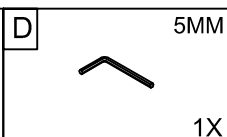
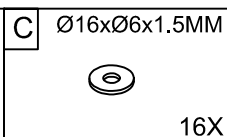
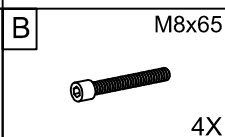
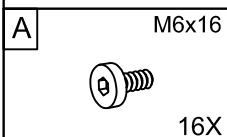

2/2

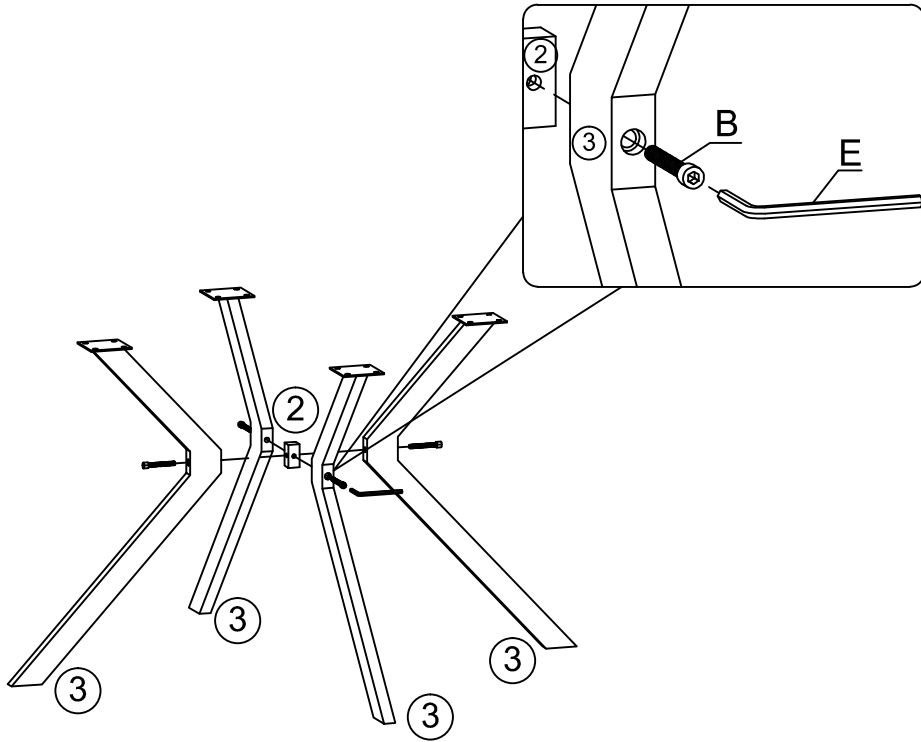

I





1

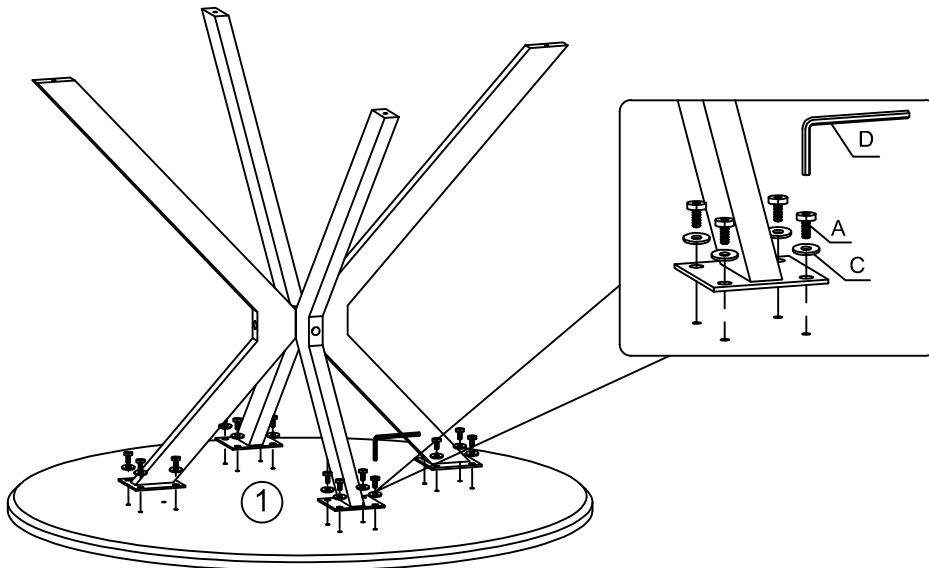

B	M8x65
	4X
E	6MM
	1X
	85%

2



A	M6x16
	16X
C	Ø16xØ6x1.5MM
	16X
D	5MM
	1X
	100%

II

3

F



4X

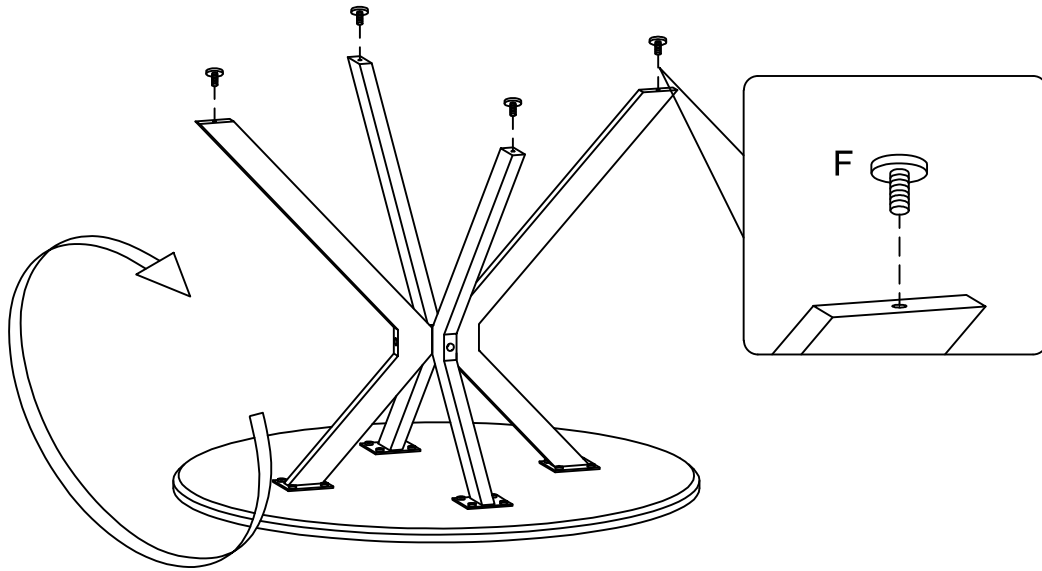

4

E

6MM



1X

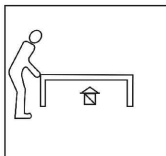

LE TRI  
+ FACILE



Séparez les éléments avant de trier