

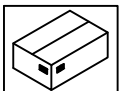

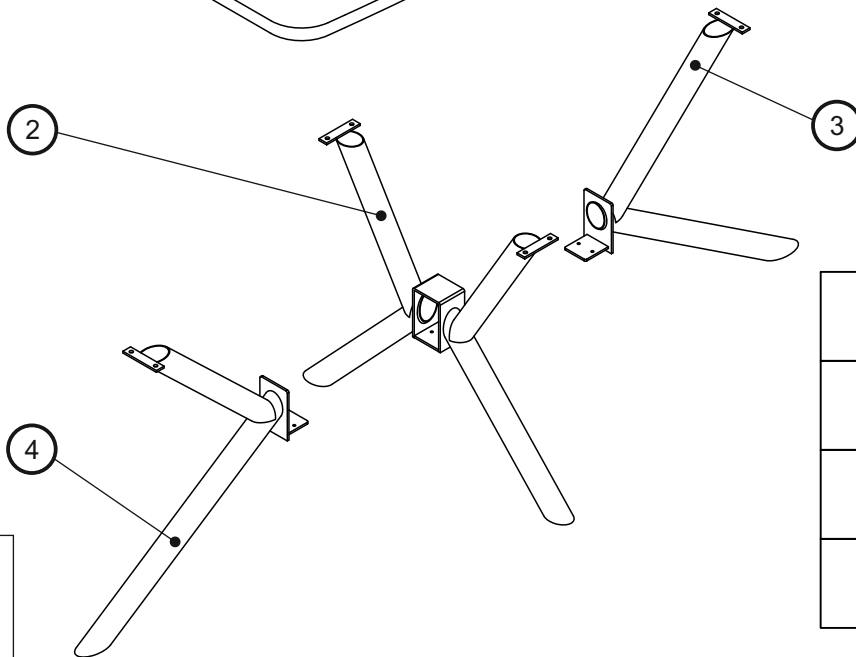

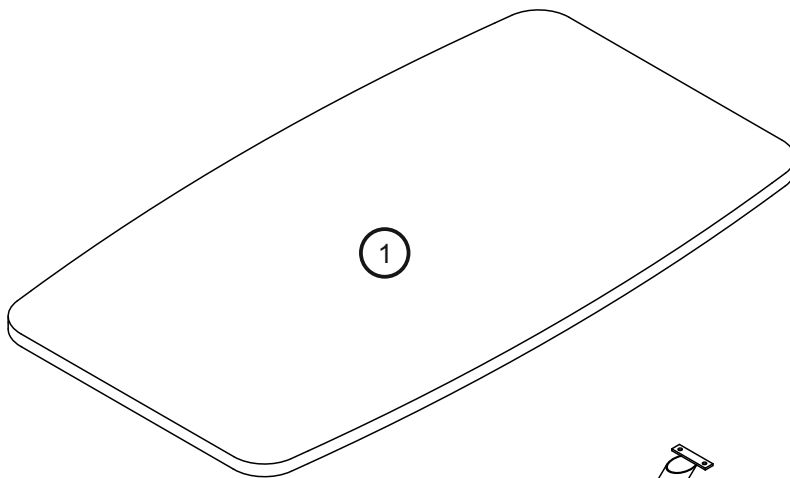

# JANELA

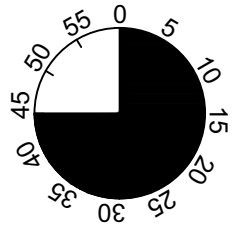
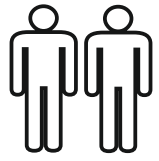
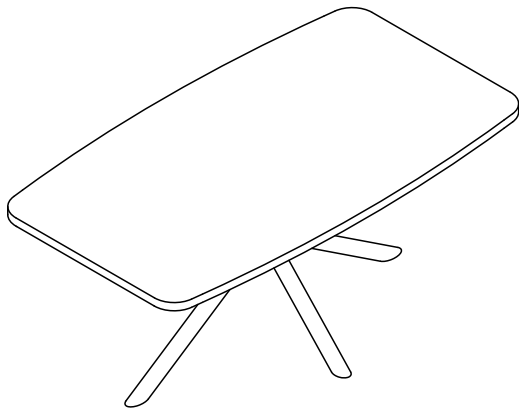
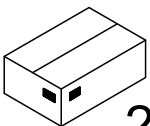

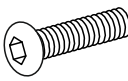
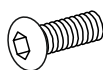
|   |    |     |
|---|----|-----|
| 1 | 1X | 1/2 |
| 2 | 1X | 2/2 |
| 3 | 1X | 2/2 |
| 4 | 1X | 2/2 |

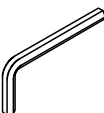

2/2

|   |       |   |        |   |            |   |            |   |         |   |     |
|---|-------|---|--------|---|------------|---|------------|---|---------|---|-----|
| <b>A</b>  | M8x25 | <b>B</b>  | M8x16  | <b>C</b>  | Ø17xØ8x1,5 | <b>D</b>  | Ø15xØ8x2,3 | <b>E</b>  | M8x12,5 | <b>F</b>  | 5MM |
|  | 2x    |  | 8x     |  | 10x        |  | 2x         |  | 8x      |  | 1x  |
| <b>G</b>  | 8MM   | <b>H</b>  | Ø34xM8 |   |            |   |            |   |         |   |     |
|  | 1x    |  | 4x     |   |            |   |            |   |         |   |     |

**I.**

1.

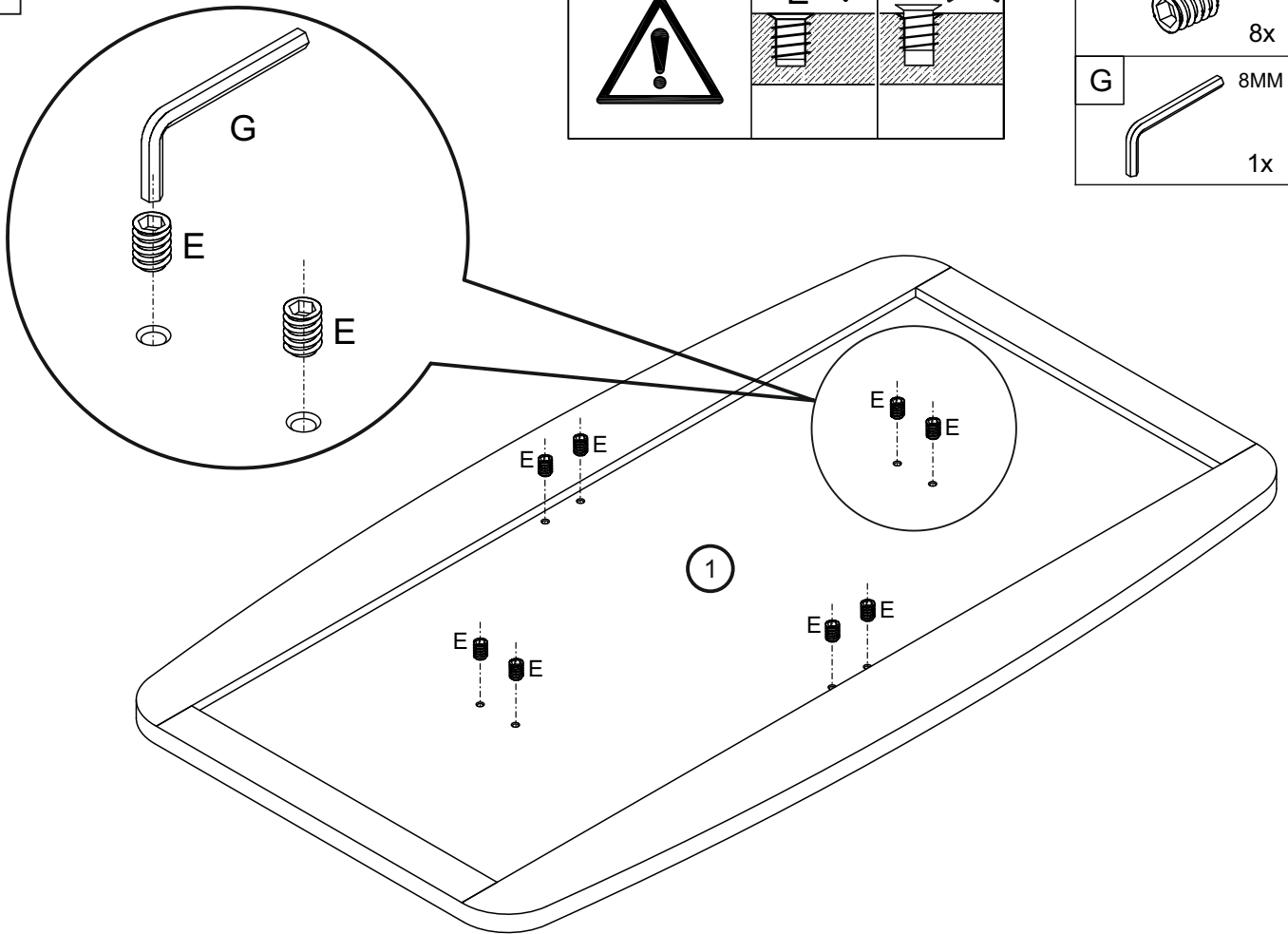

|   |         |
|---|---------|
| E | M8x12,5 |
|   | 8x      |
| G | 8MM     |
|   | 1x      |

2.

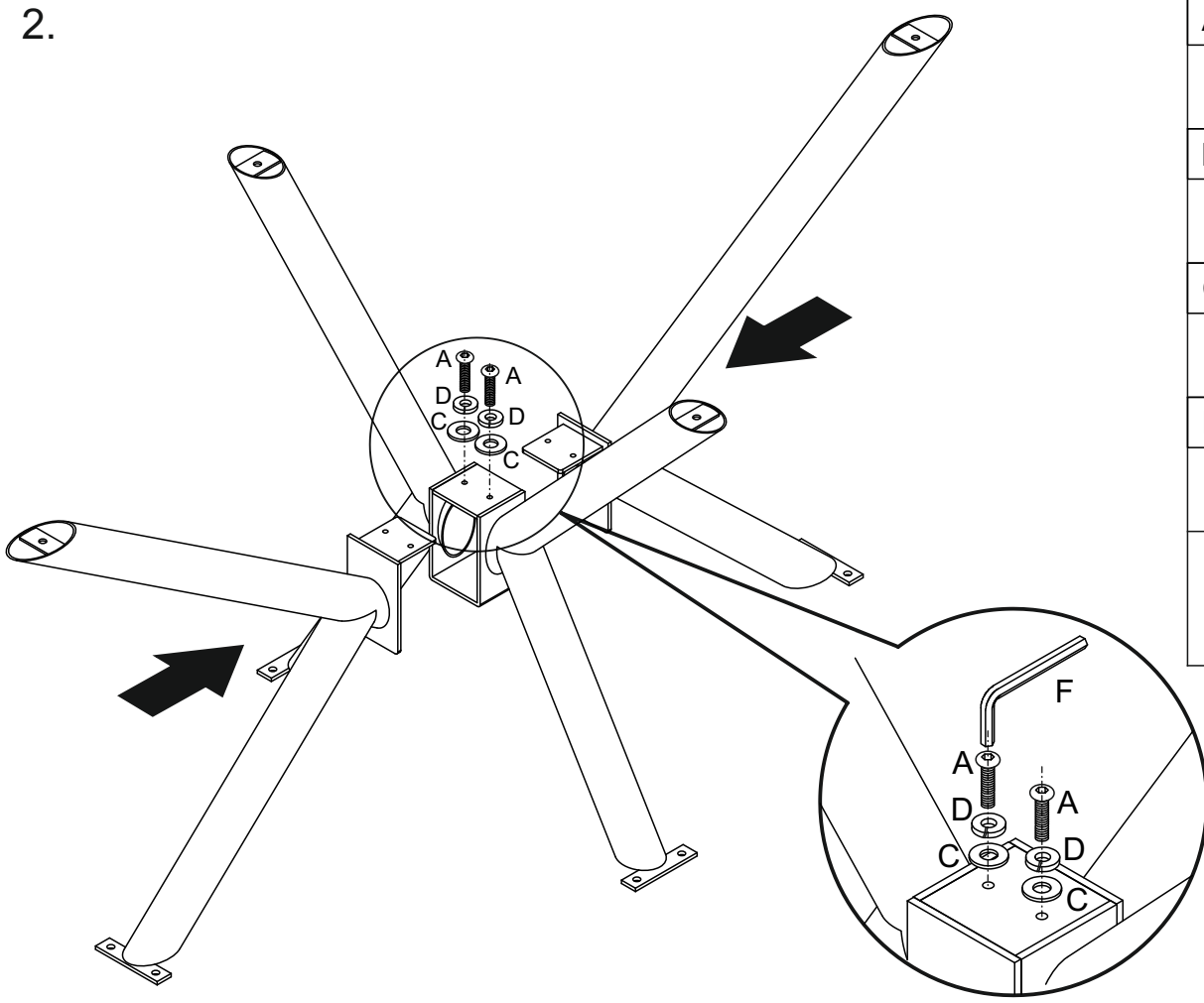

|   |            |
|---|------------|
| A | M8x25      |
|   | 2x         |
| F | 5MM        |
|   | 1x         |
| C | Ø17xØ8x1,5 |
|   | 2x         |
| D | Ø15xØ8x2,3 |
|   | 2x         |
|   | 75%        |

II.

3.

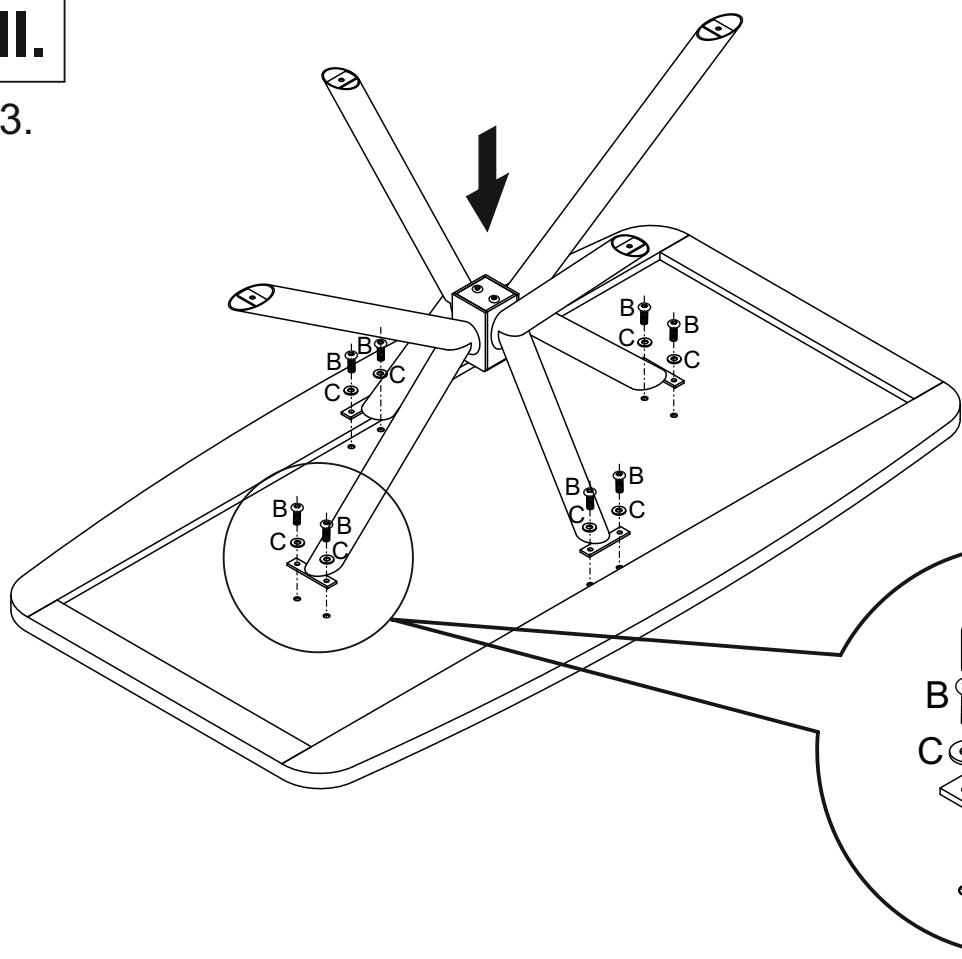

|   |            |
|---|------------|
| B | M8x16      |
|   | 8x         |
| F | 5MM        |
|   | 1x         |
| C | Ø17xØ8x1,5 |
|   | 8x         |
|   |            |

4.

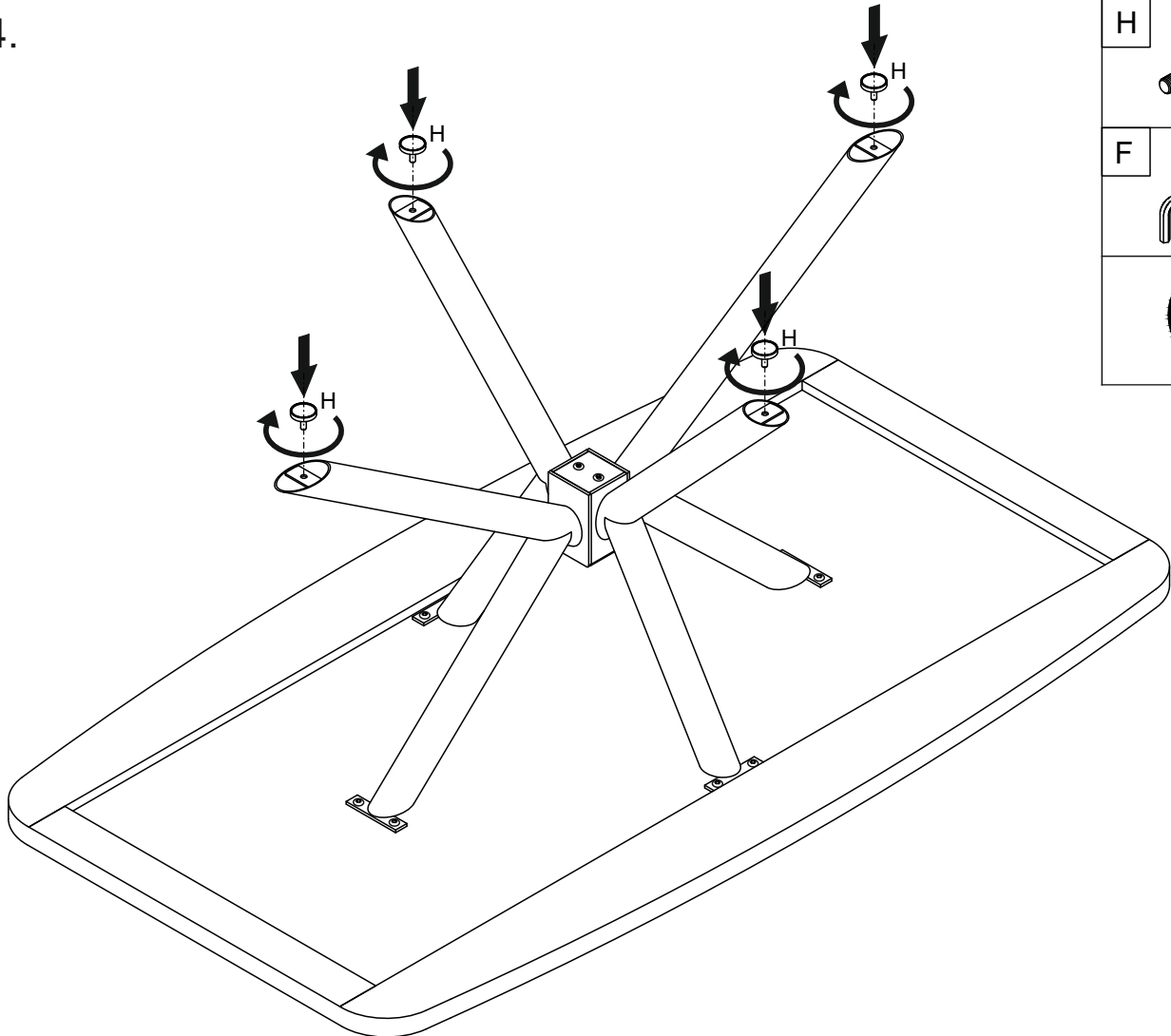

|   |        |
|---|--------|
| H | Ø34xM8 |
|   | 4x     |
| F | 5MM    |
|   | 1x     |
|   |        |

III.

5.

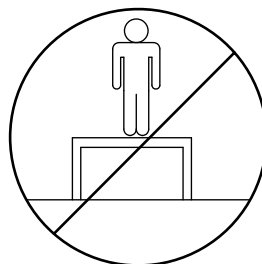
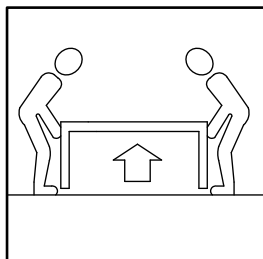
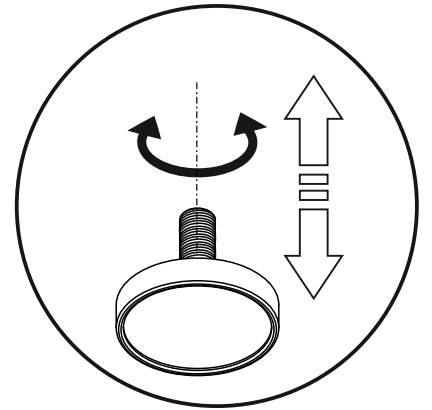
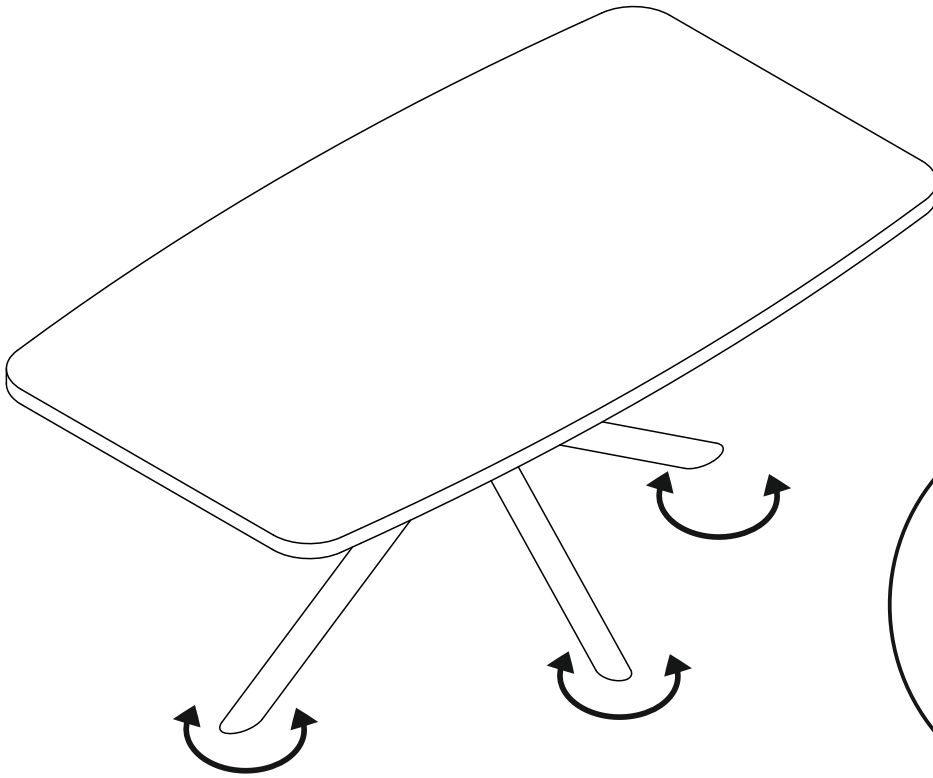
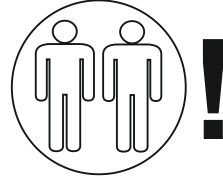
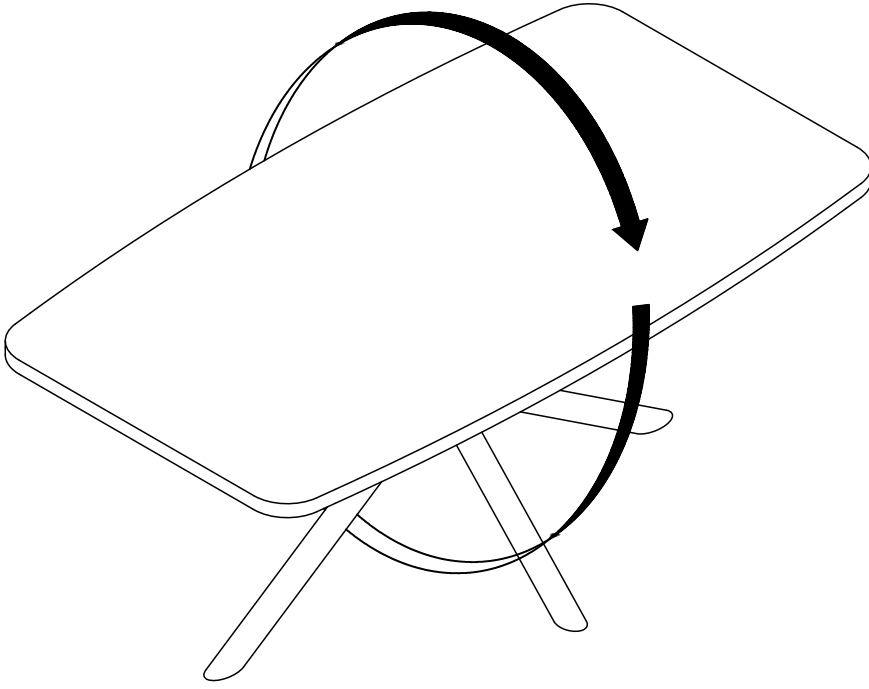

Séparez les éléments avant de trier