

Carlos

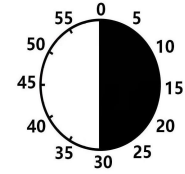

①

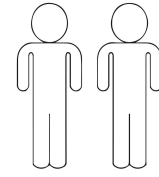
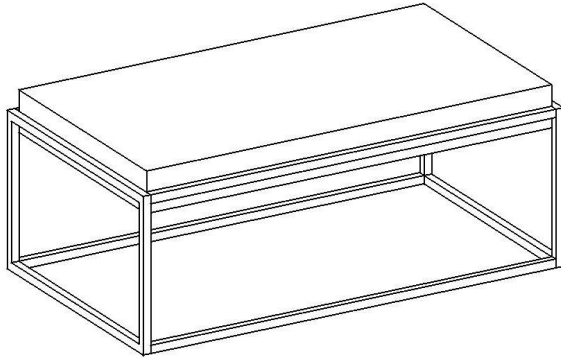
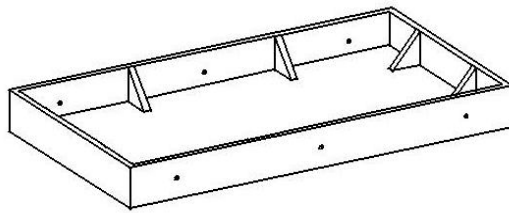

②

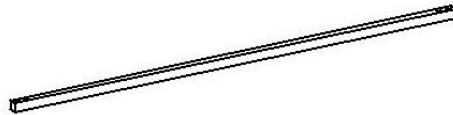

③

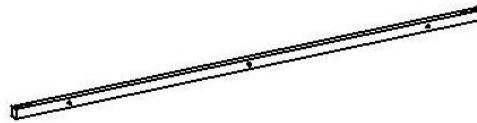

④

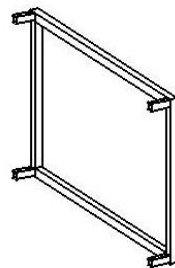

1	1x
2	2x
3	2x
4	2x



1/1

A

M6x10mm



16x

B

M6x30mm



6x

C

Φ16xΦ6x1mm



22x

D

M4

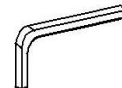

1x

I.

1

A	M6x10mm	16x
C	Φ16xΦ6x1mm	16x
D	M4	1x

75%

2

B	M6x30mm	6x
C	Φ16xΦ6x1mm	6x
D	M4	1x

75%

D	M4	1x
---	----	----

100%

3

D	M4	1x
---	----	----

100%

LE TRI + FACILE

BAC DE TRI