

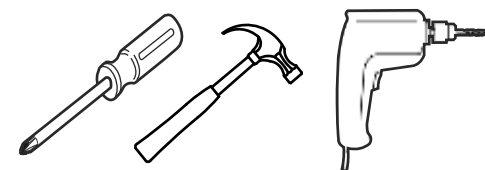

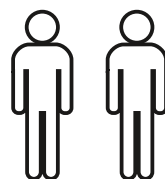

Jídelní sestava VINA 6 Jedáľenská zostava VINA 6

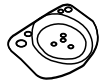
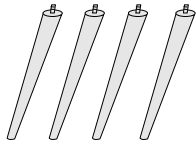

SEZNAM P ÍSLUŠENSTVÍ//ZOZNAM PRÍSLUŠENSTVA

			
X 4 (IRON)	X 4 (FURNITURE LEG)	X 4 (BOLD NUT)	6x15 VÍDA X 16 (6x15 SCREW)
			
ANAHTAR X 1 (WRENCH)			

* P ÍSLUŠENSTVÍ UPEVN ĚTE PODLE NÁVODU P Í INSTALACI PRODUKTU
POSTUPUJTE PODLE INSTALA ĚNÍHO PO ĚDÍ.

* PRÍSLUŠENSTVO PRIPEVNĚTE POD ĚA NÁVODU. PRI INŠTALÁCII VÝROBKU
POSTUPUJTE POD ĚA INŠTALA ĚNÉHO PORADIA.

* FIX THE ACCESORIES AS SHOWN FOLLOW THE
INSTALLATION SEQUENCE WHILE INSTALLING THE PRODUCT.

1

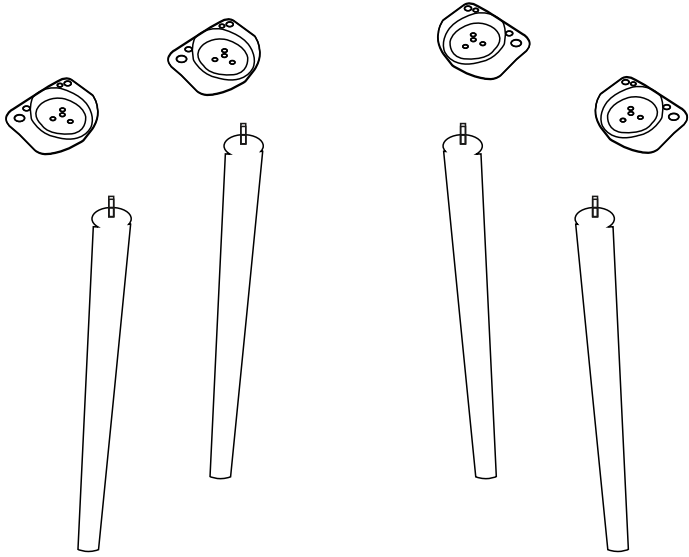
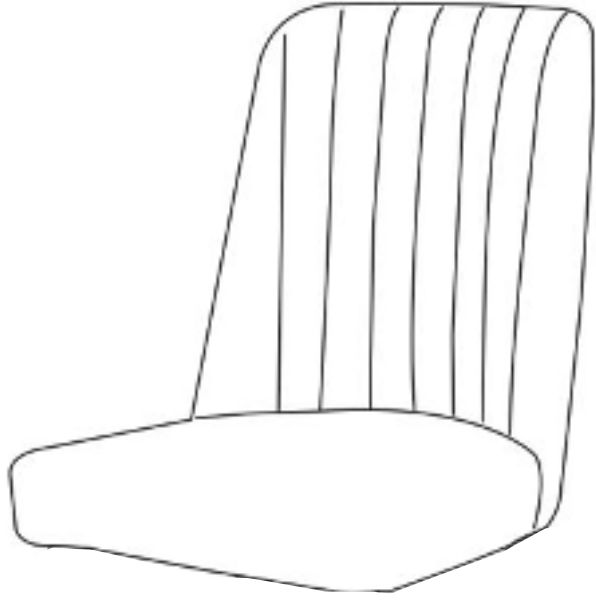

2

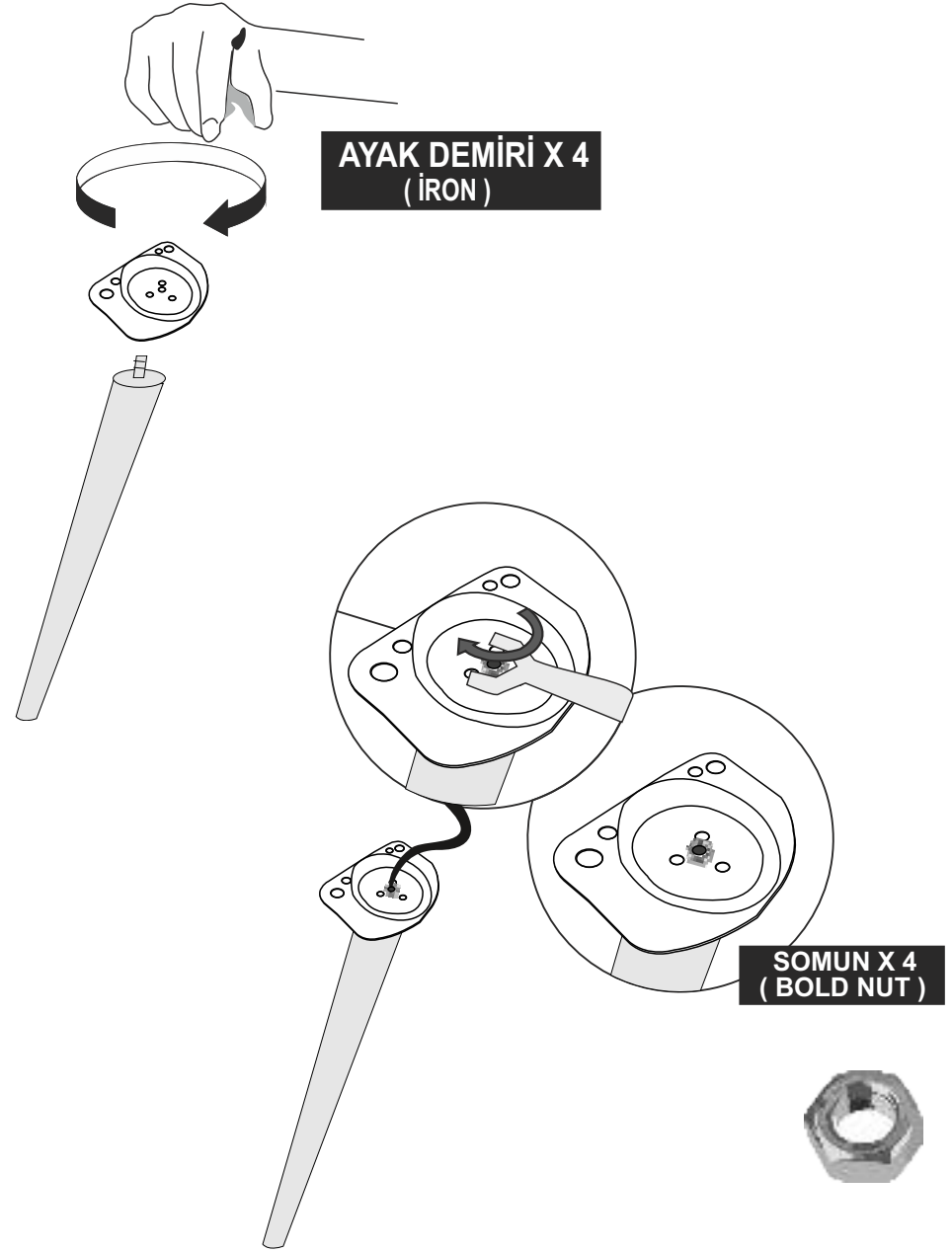

3

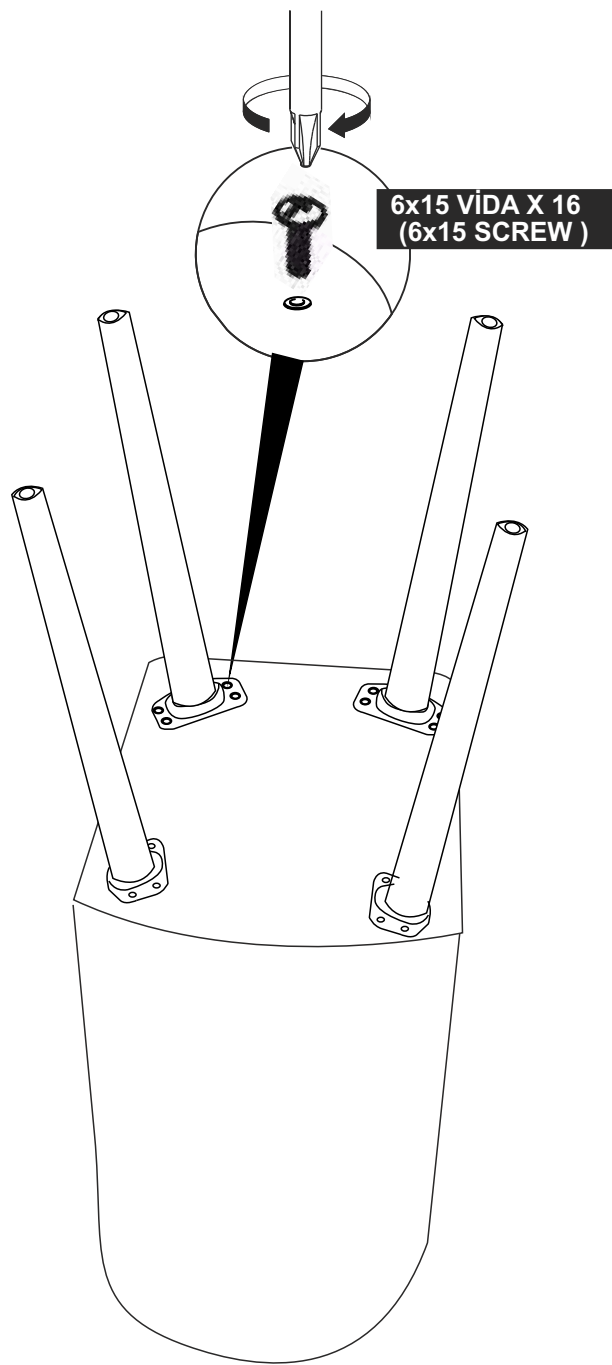

4



5

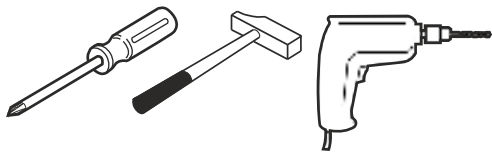
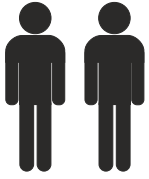

6 X 40 CÍVATA x 8

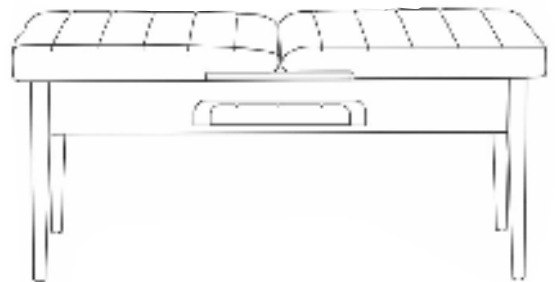
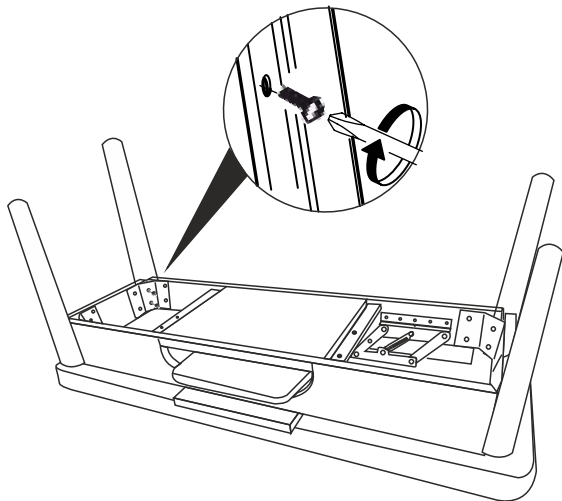
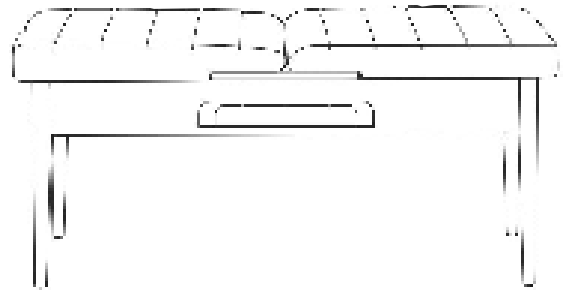

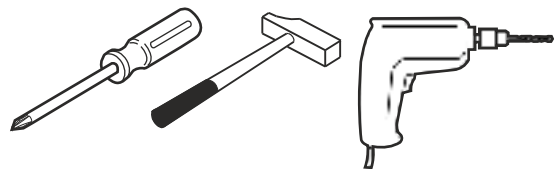
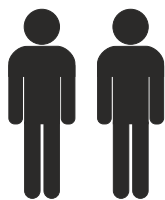

6 X 40 CÍVATA x 8

