

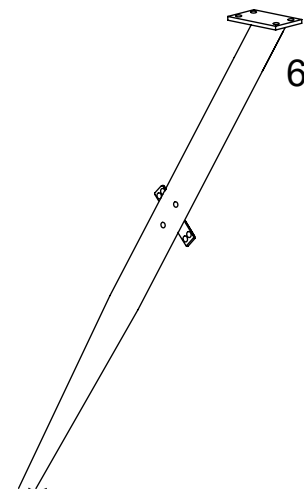

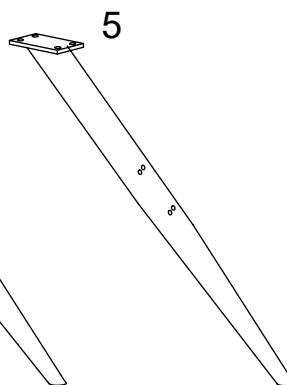

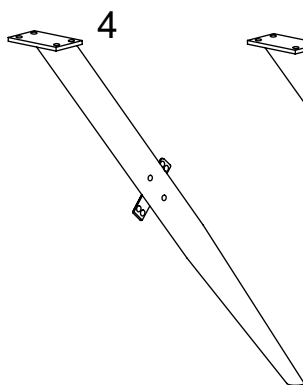

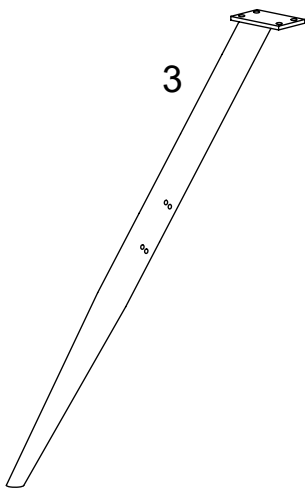
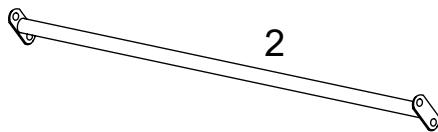
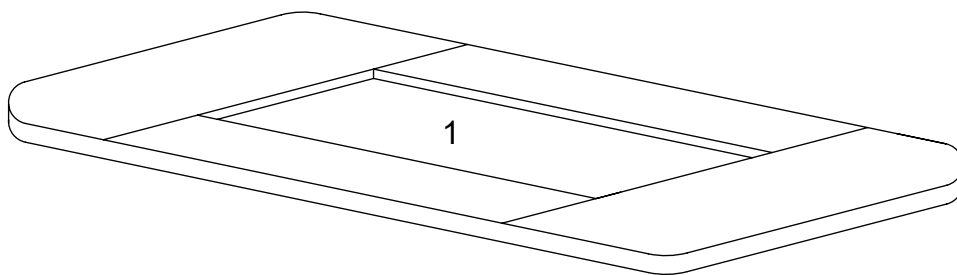
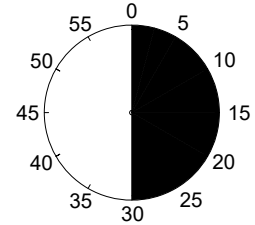
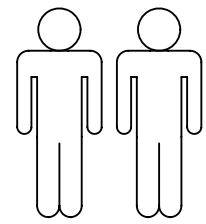
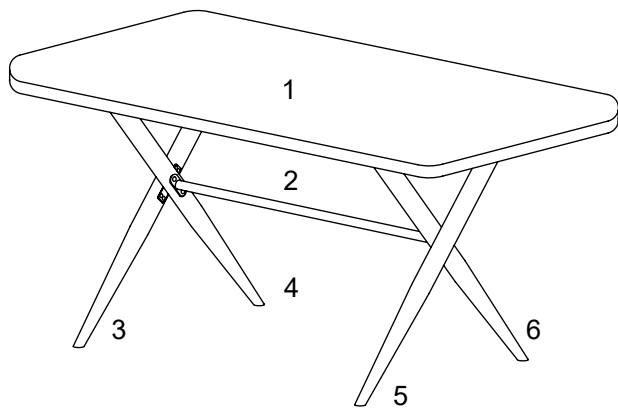

ELORCA





		
1	1 x	1/2
2	1 x	2/2
3	1 x	2/2
4	1 x	2/2
5	1 x	2/2
6	1 x	2/2

 1/2	 4,5x35 16x	 M6x18	 SW 4 1x			
 2/2	 12x					

I.

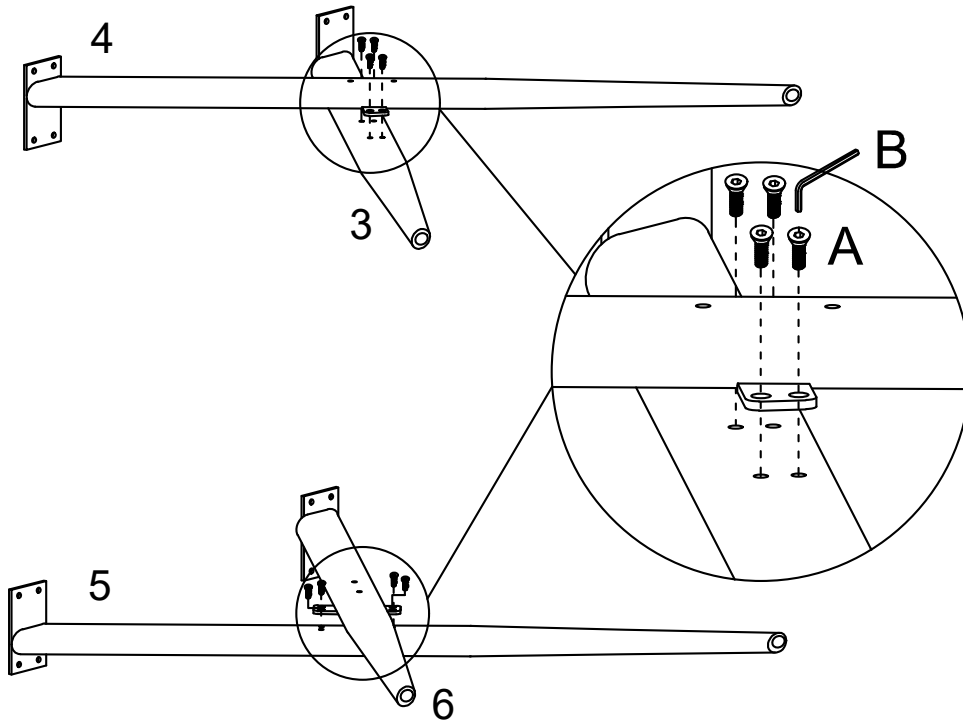

1.

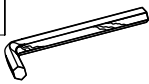

A		M6x18
		8x
B		SW 4
		1x

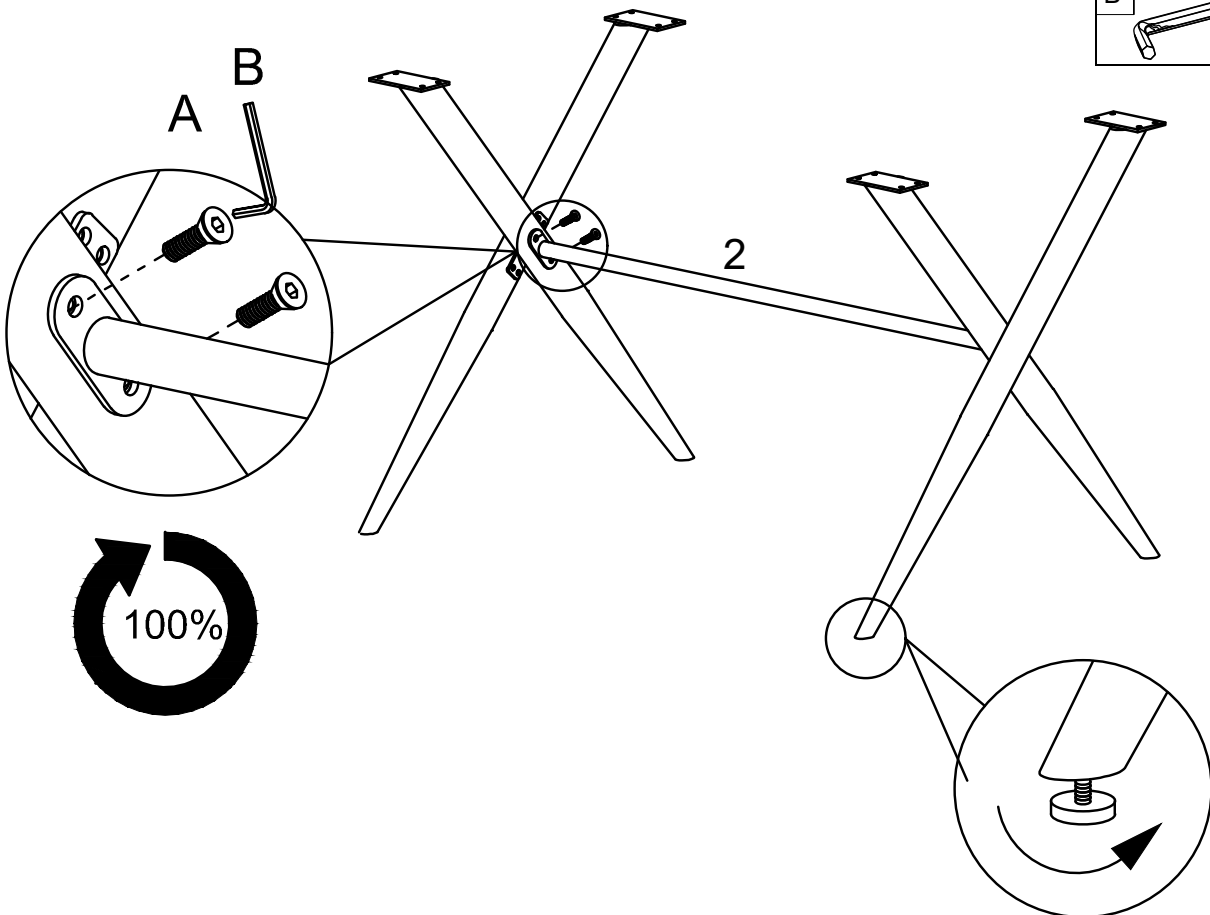
2.



A		M6x18
		4x
B		SW 4
		1x

II.

C 4,5x35
16x

3.

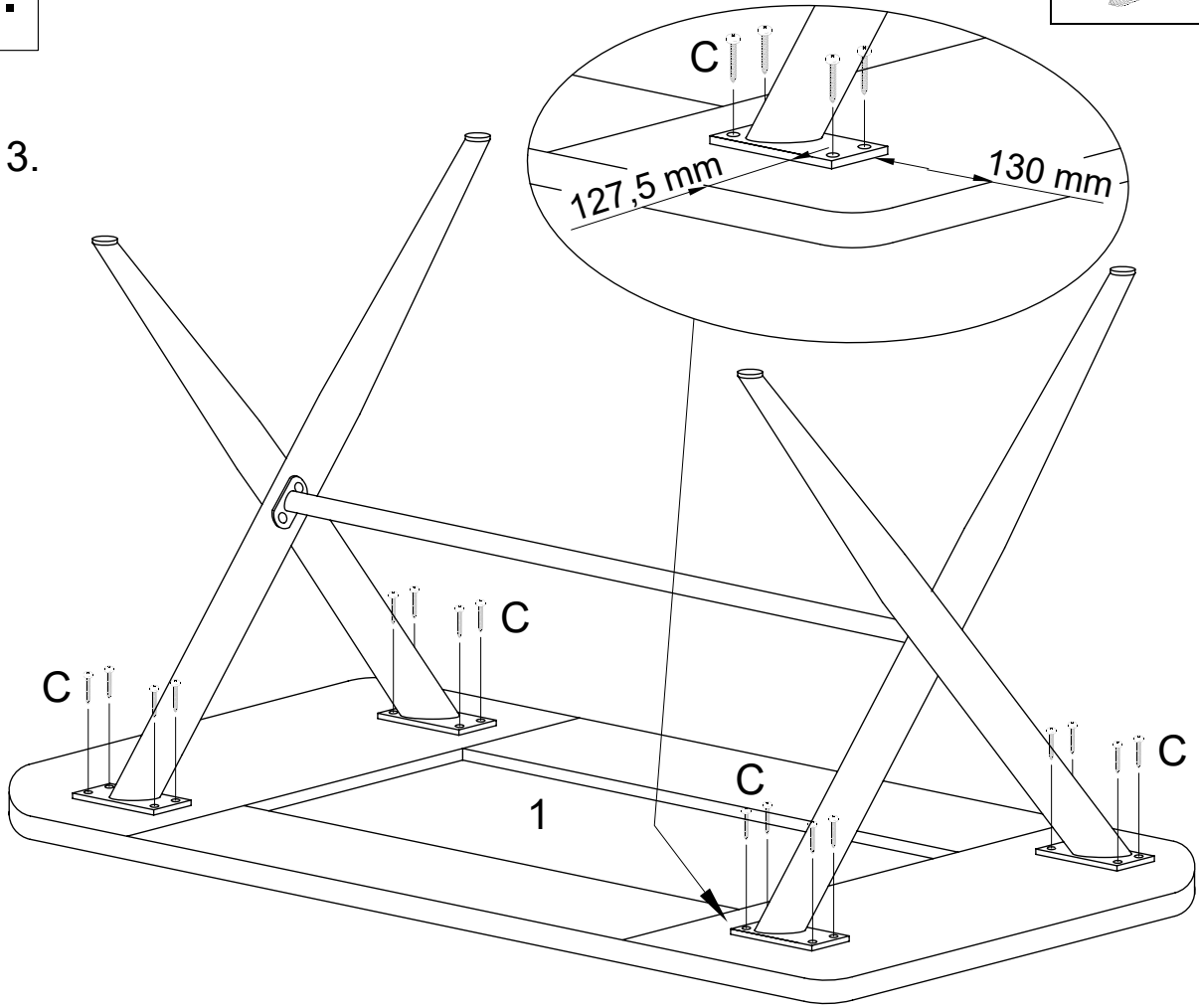

4.

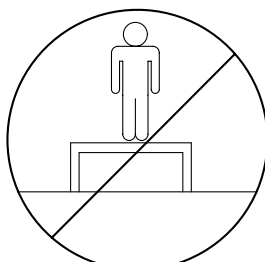
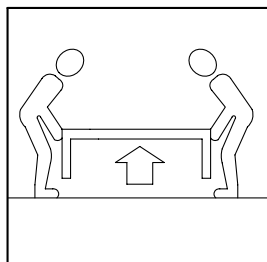
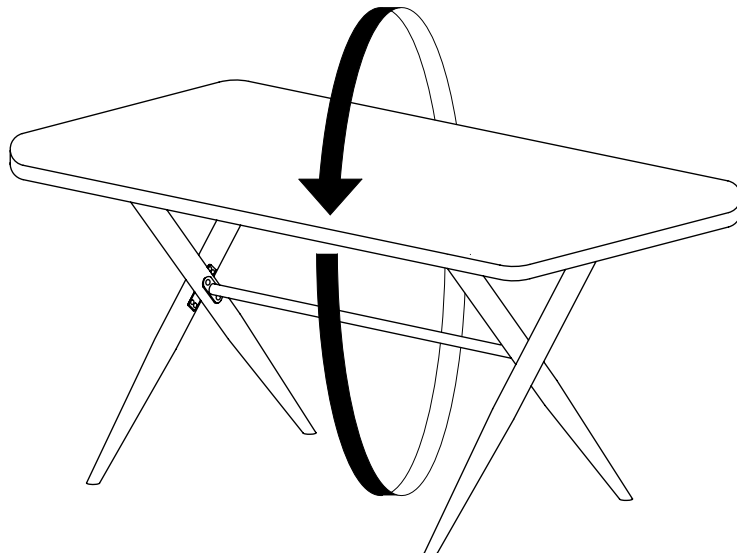
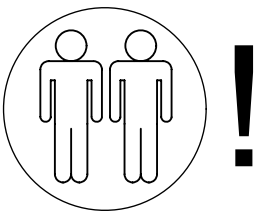

LE TRI
+ FACILE



Séparez les éléments avant de trier