

**Name:**

**Art.Nr.:**

**EAN:**

**Order:**

## **Montageanleitung / Notice de Montage / Assembling Instruction**

DE: Wichtige Montage – Tipps hier zum herunterladen:

EN: Important assembling suggestions download:

FR: Conseils de montage importants à télécharger ici :

BG: Важни съвети за сглобяване, които да изтеглите от тук:

CZ: Důležité montážní tipy ke stažení zde:

EE: Olulised kokkupanemisetpanekute allalaadimine:

DK: Vigtige montage tips til at downloade:

ES: Descarga de sugerencias de montaje importantes:

FI: Tärkeät kokoamisedotukset ladataan:

GR: Λήψη σημαντικών προτάσεων συναρμολόγησης:

HR: Preuzimanje važnih prijedloga za sastavljanje:

HU: Fontos összeszerelési javaslatok letöltése:

IT: Download importanti suggerimenti di montaggio:

LT: Svarbūs surinkimo pasiūlymai atsisiųsti:

LU: Wichteg Versammlungsvirschléi eroflueden:

LV: Svarīgu montāžas ieteikumu lejupielāde:

NL: Belangrijke montagesuggesties downloaden:

NO: Viktige nedlastingsforslag:

PL: Pobieranie ważnych sugestii montażowych:

PT: Download de sugestões importantes de montagem:

RO: Descărcare de sugestii importante de asamblare:

RS: Преузимање важних предлога за састављање:

RU: Важные предложения по сборке скачать.:

SL: Prenos pomembnih predlogov za sestavljanje:

SE: Viktiga hämtningsförslag:

SK: Stiahnutie dôležitých návrhov na zostavenie:

TR: Önemli montaj önerileri indir:

ARB: المهمة التجميع اقتراحات تنزيل:



Z. A. du Niederwald

F-67470 Seltz

[www.interlink-sas.com](http://www.interlink-sas.com)



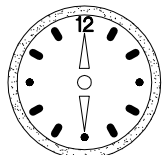
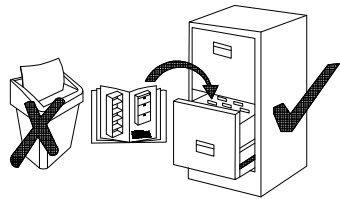
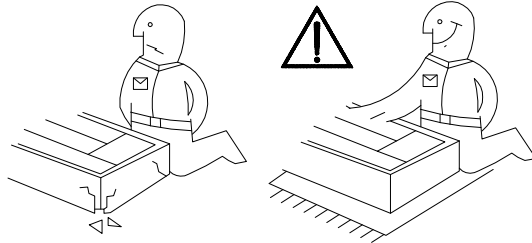
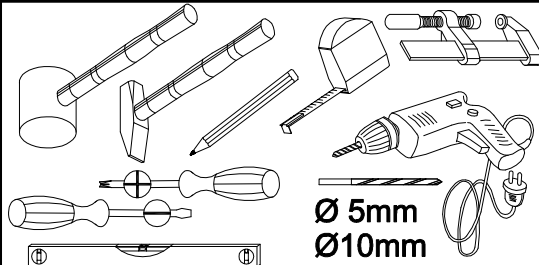
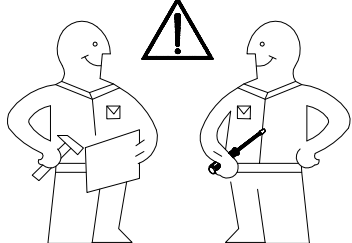

90 min

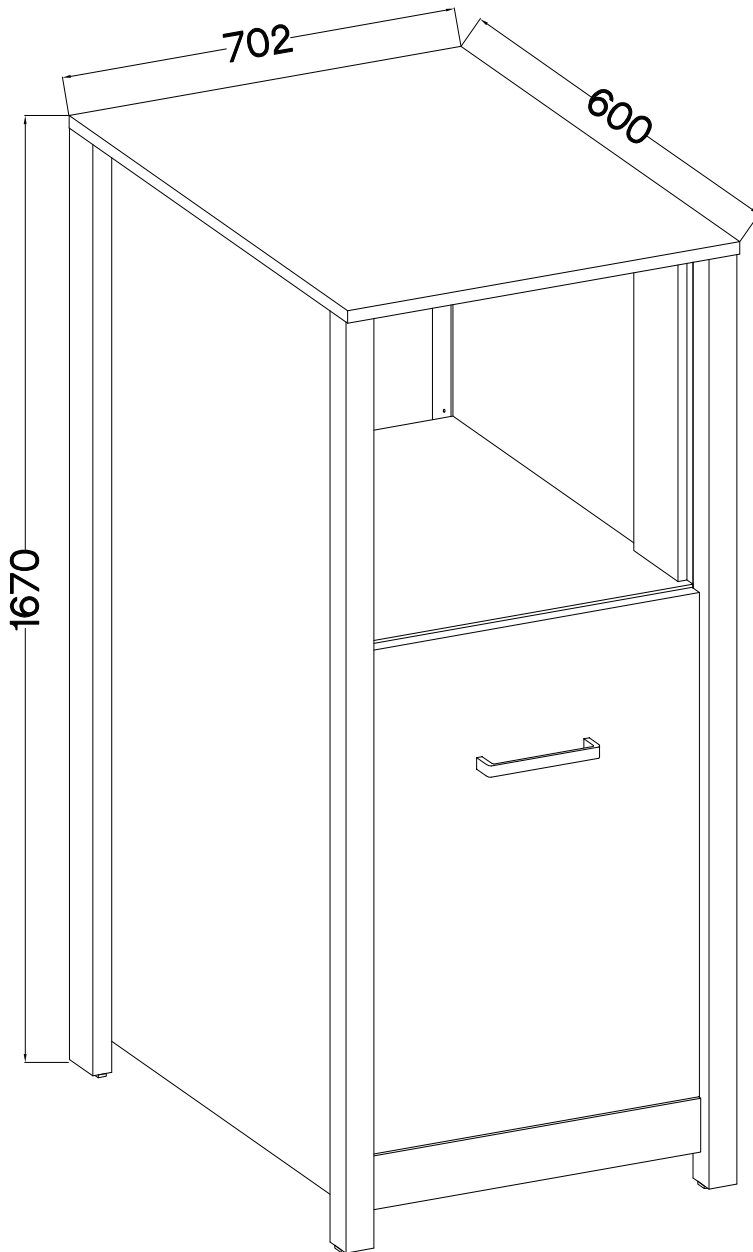
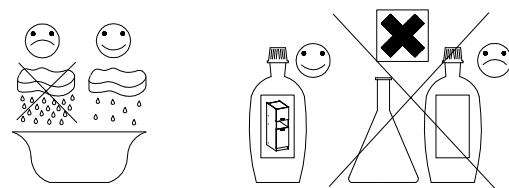

†8x30mm  A	6,4 x 35mm  B1	†15/12mm  C	L=20mm  D2	 E	L=28 mm  F37	†35/16mm [CD]  HG2	†5/16mm  J3	†8/11mm  J41	 L	 O
20	8	20	20	10	4	2	8	4	6	1
120x30x15mm  L25	†10x50mm  O7	†4.0x16mm  P1	†3.5x13mm  P5	†3.0x20mm  P7	†5.0x60mm  P12	†4.0x25mm  R	L=192mm  S	 T3	 U	M4x22mm
2	2	12	8	10	2	4	1	6	2	

ISM-SLA-001

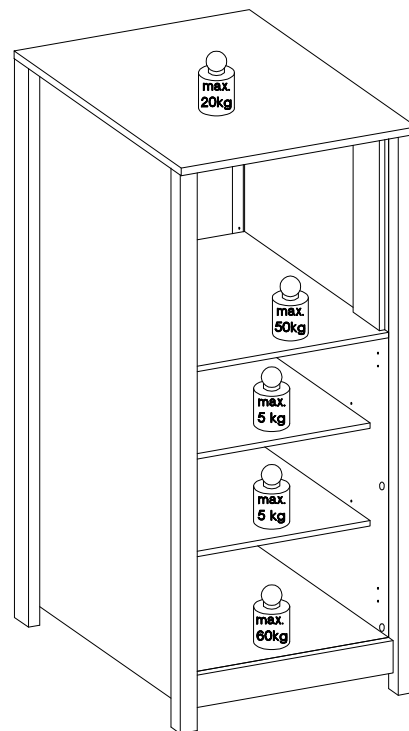
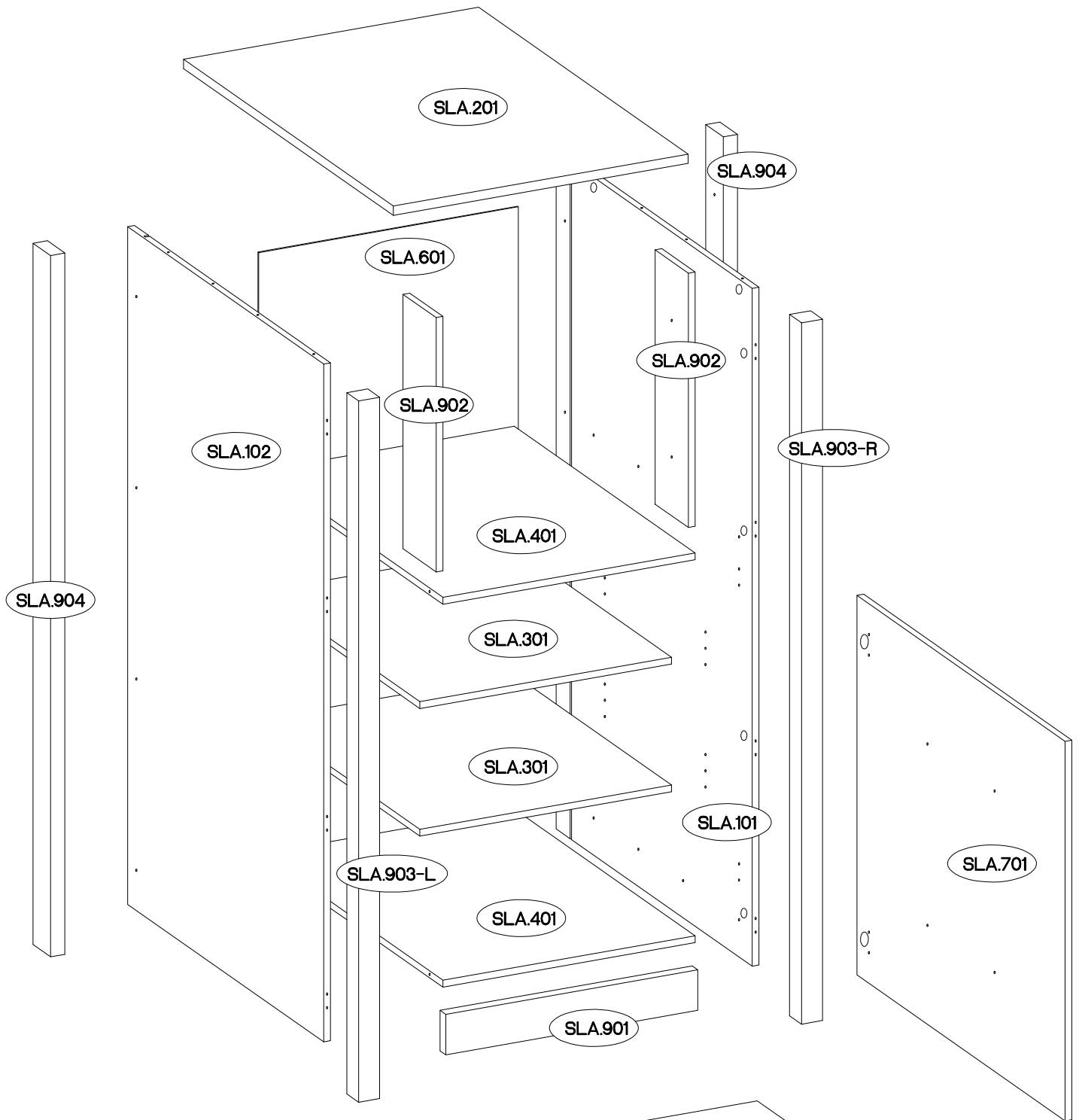

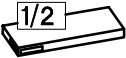
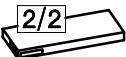
	Ersatzteil Nummer	Dimension
	SLA.201	702x600x22
	SLA.401 x2	600x517x16
	SLA.301 x2	599x450x16
	SLA.901	600x95x16
	SLA.902 x2	596x120x16
	SLA.601	912x618x2,5
	SLA.701	889x596x16
	SLA.101	1588x561x16
	SLA.102	1588x561x16
	SLA.903-R	1643x50x34
	SLA.903-L	1643x50x34
	SLA.904 x2	1643x50x34

## VARIANT 1

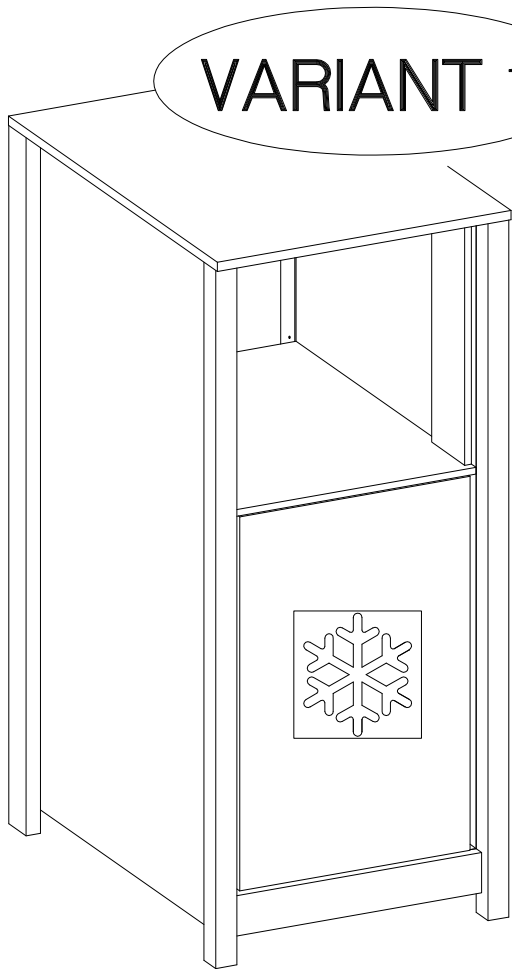

Kühlschrank  
/ Fridge

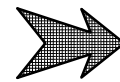
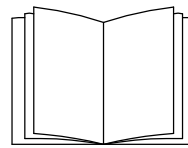

1 — 11

## VARIANT 2

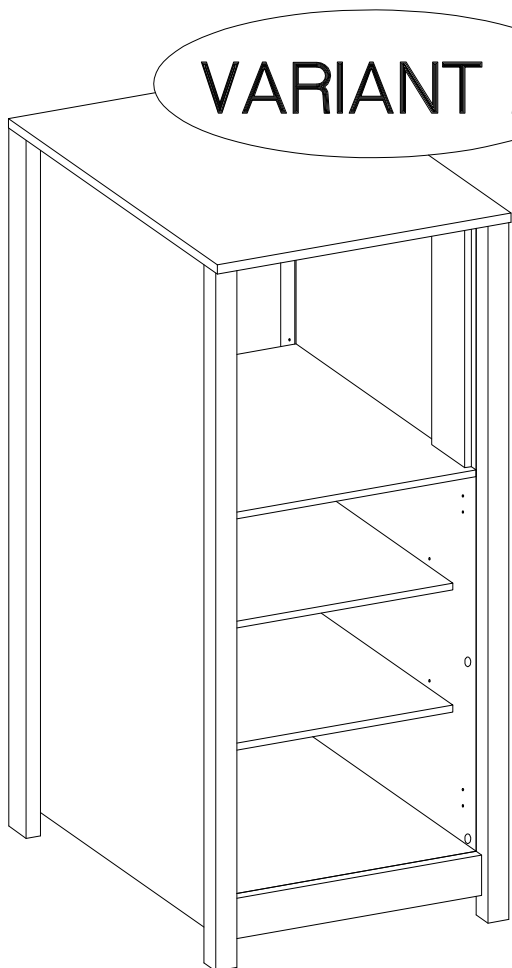



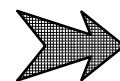
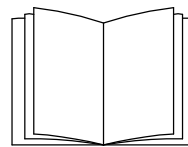



Stauraum  
/ Storage



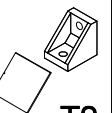

1 — 6

12 — 16

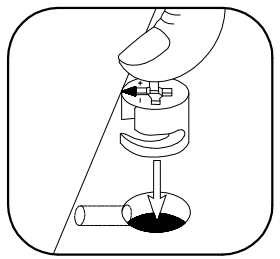
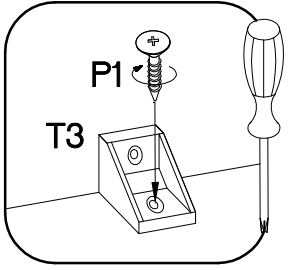
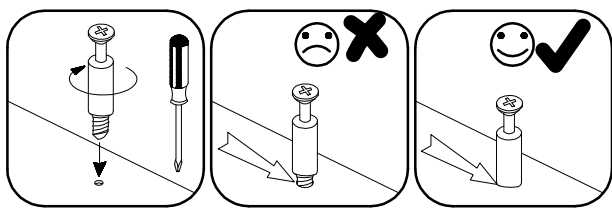
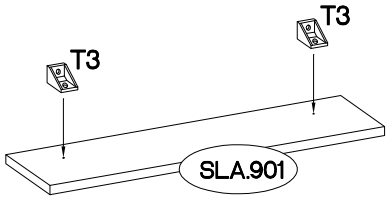
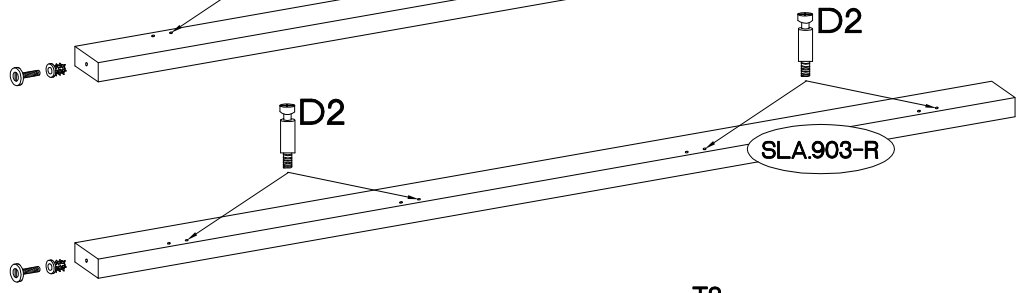
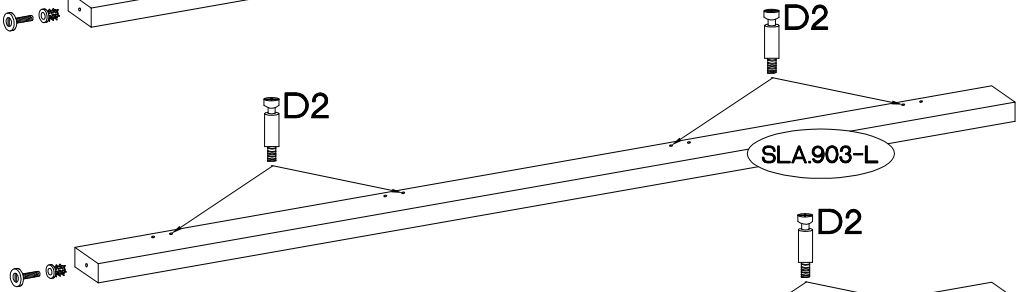
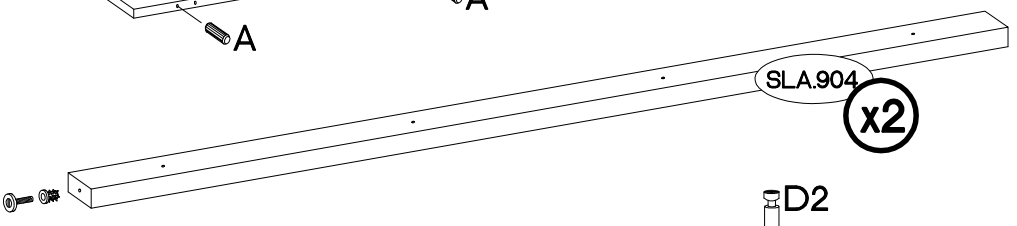
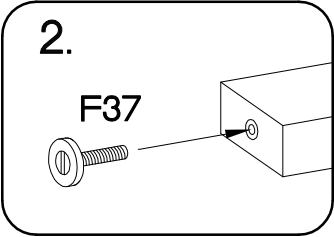
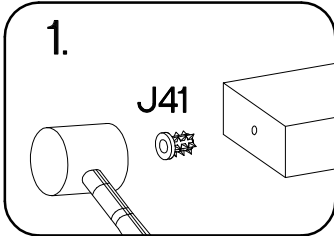
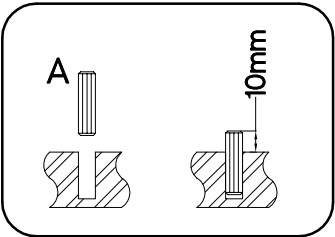
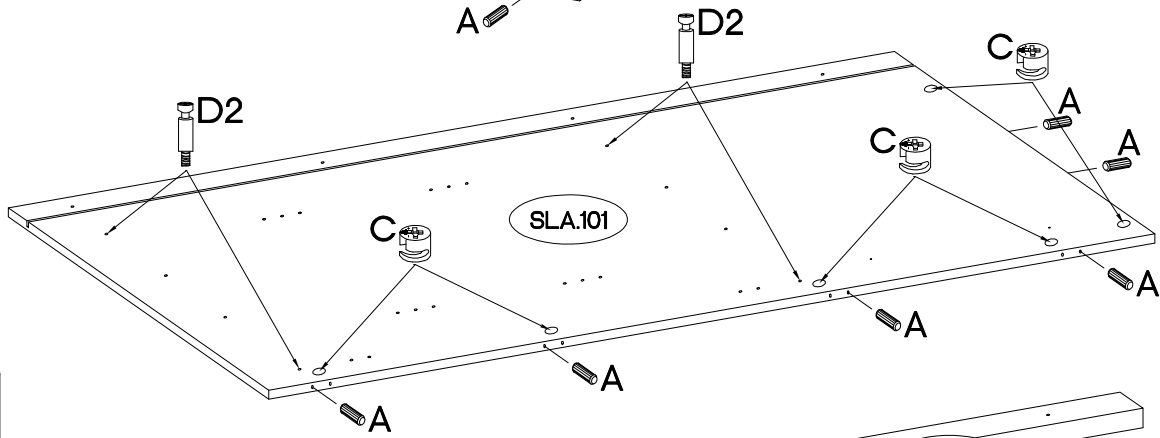
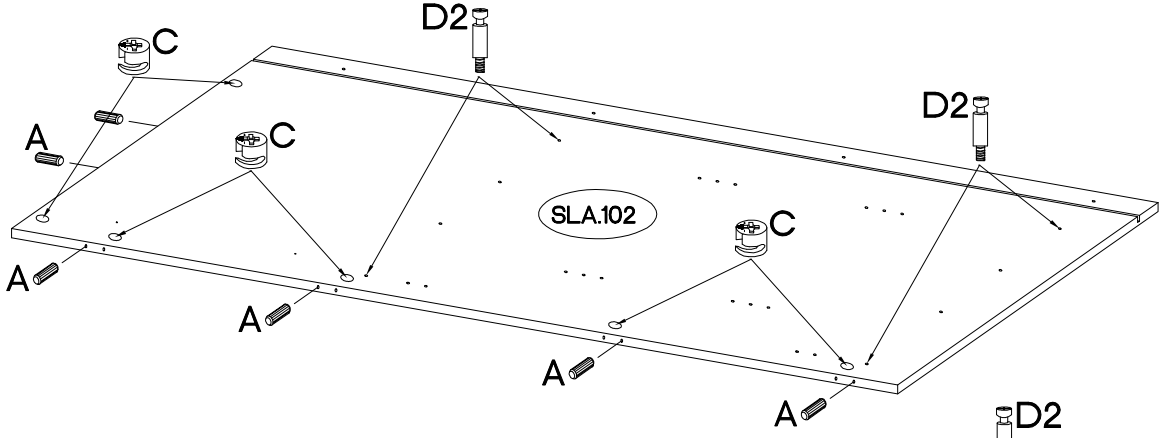
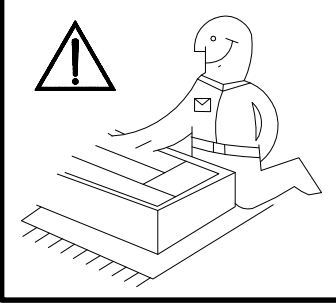
+8x30mm  A 12	+15/12mm  C 12	L=20mm  D2 16	+8/11mm  J41 4	L=28 mm  F37 4	 T3 2	+4.0x16mm  P1 2
--	---	--	---	---	---	--



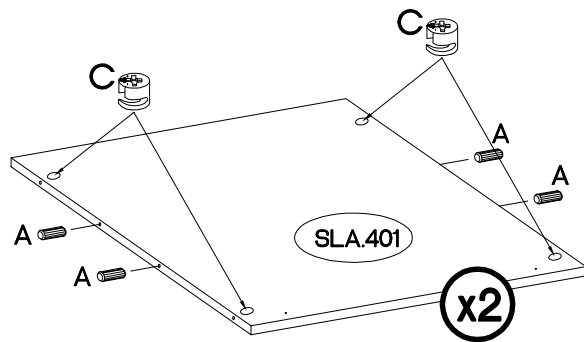
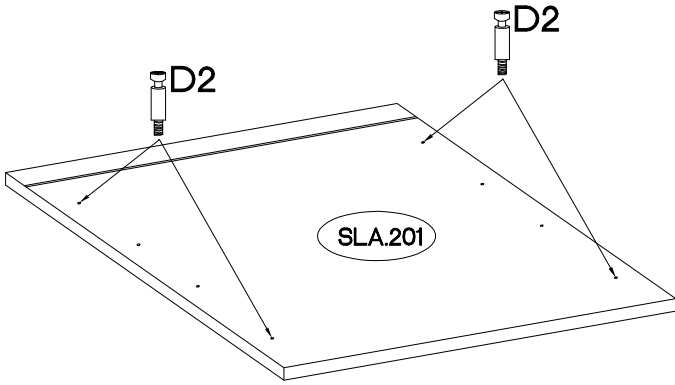
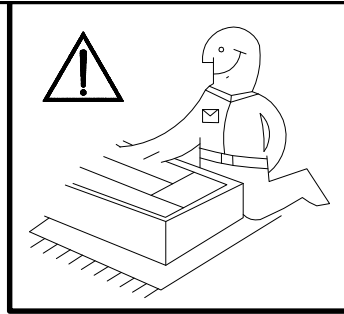
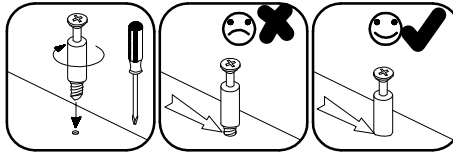

2

 #15/12mm C 8	 L=20mm D2 4	 #8x30mm A 8
--	---	---

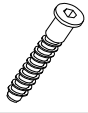

3

 6,4 x 35mm B1 8	 O 1
--	---

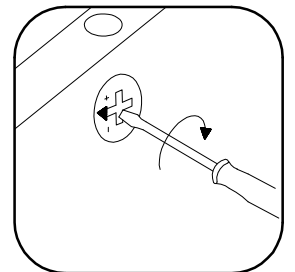
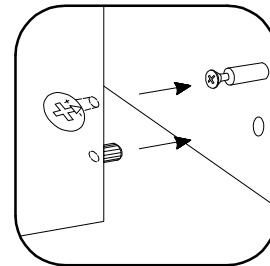
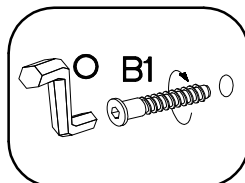
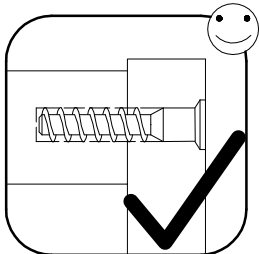
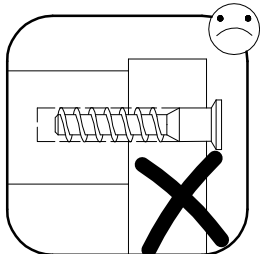
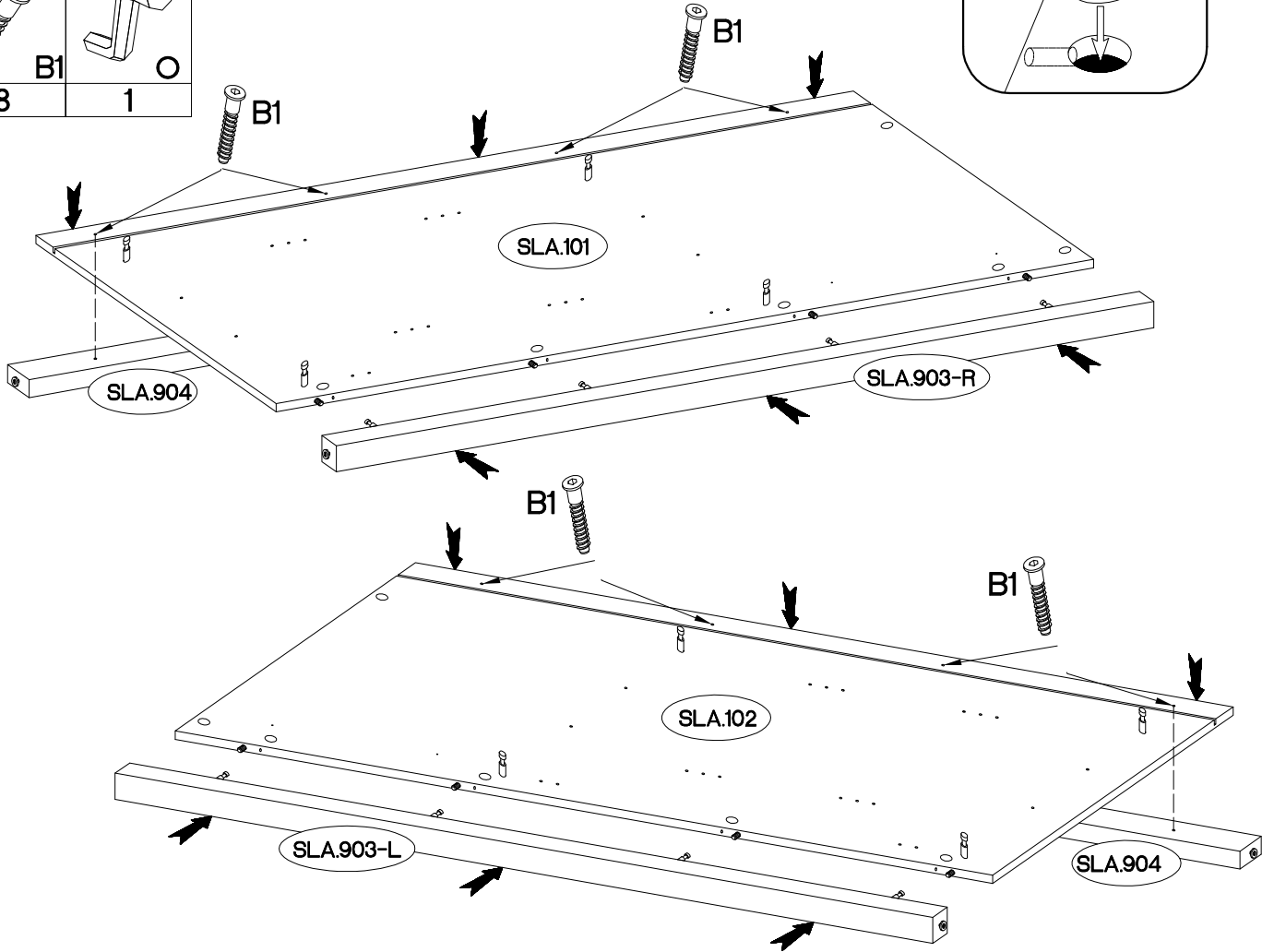
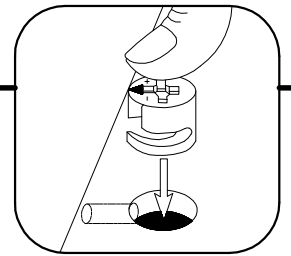

4

+4.0x16mm

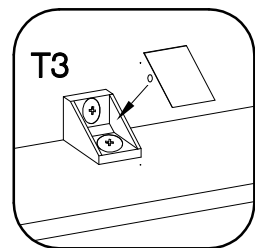
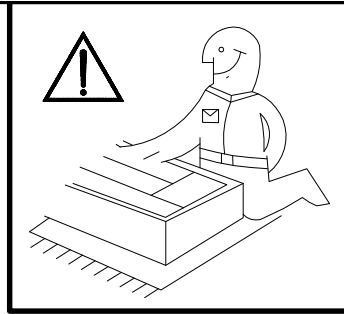
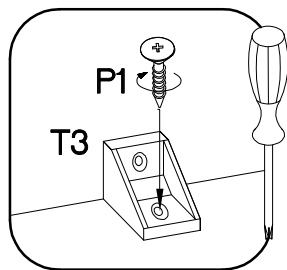
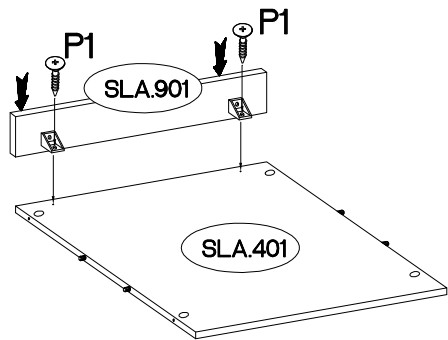
P1
2



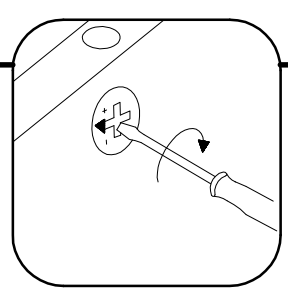
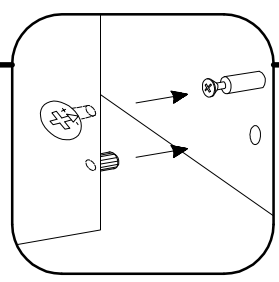
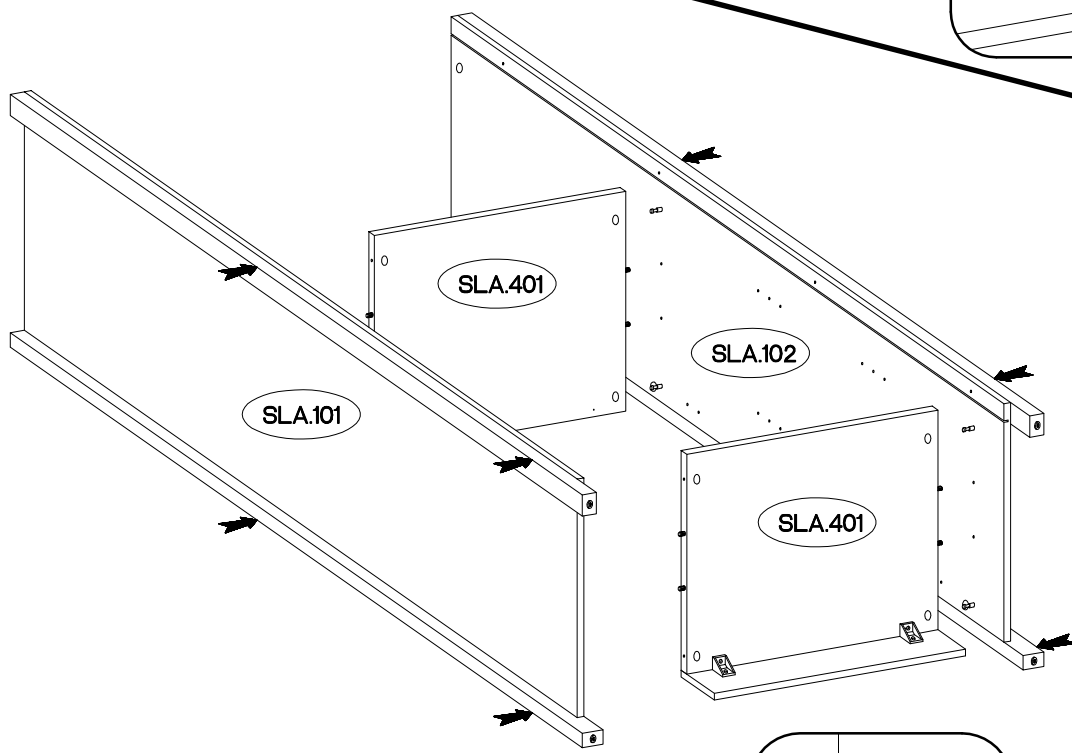

5

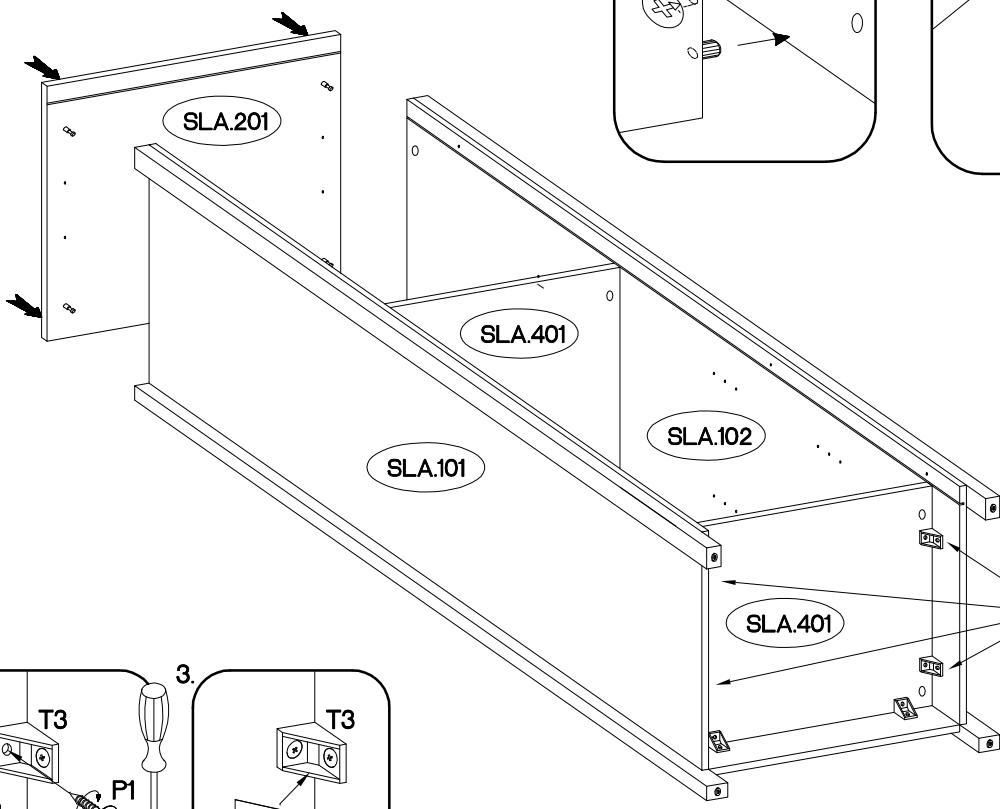

6

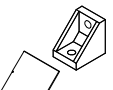

	+4.0x16mm
T3	
4	P1
	8

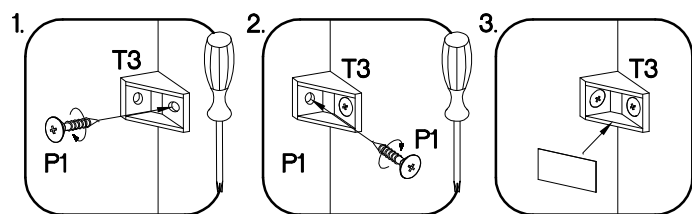

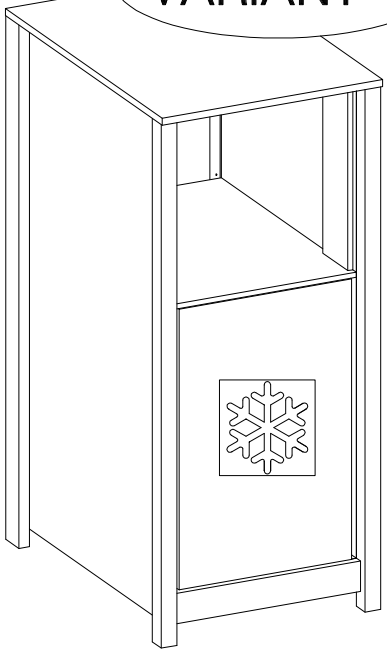

VARIANT 1

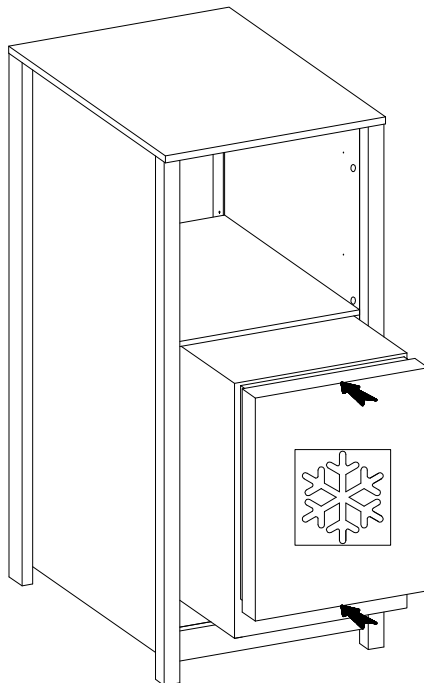
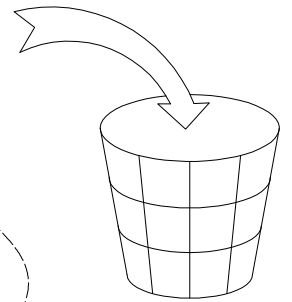
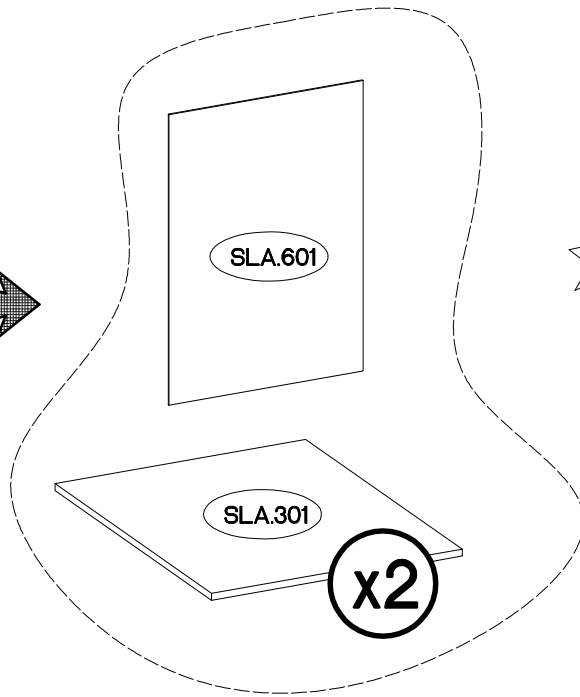
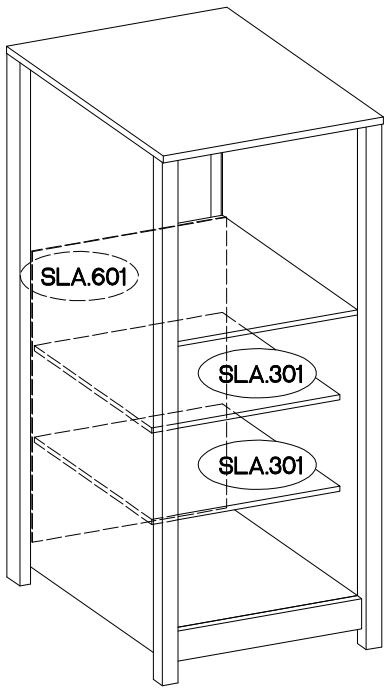
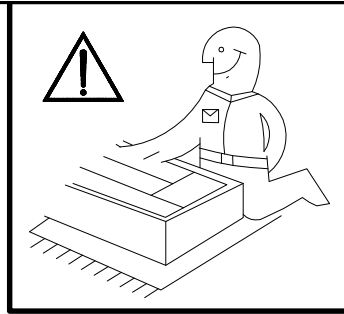

Kühlschrank  
/ Fridge

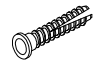

†5.0x60mm  P12 2	120x30x15mm  L25 2
†3.5x13mm  P5 4	†10x50mm  O7 2

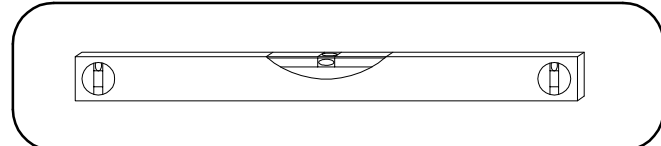
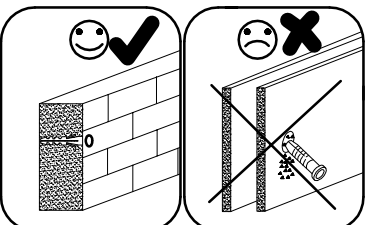
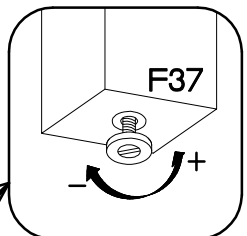
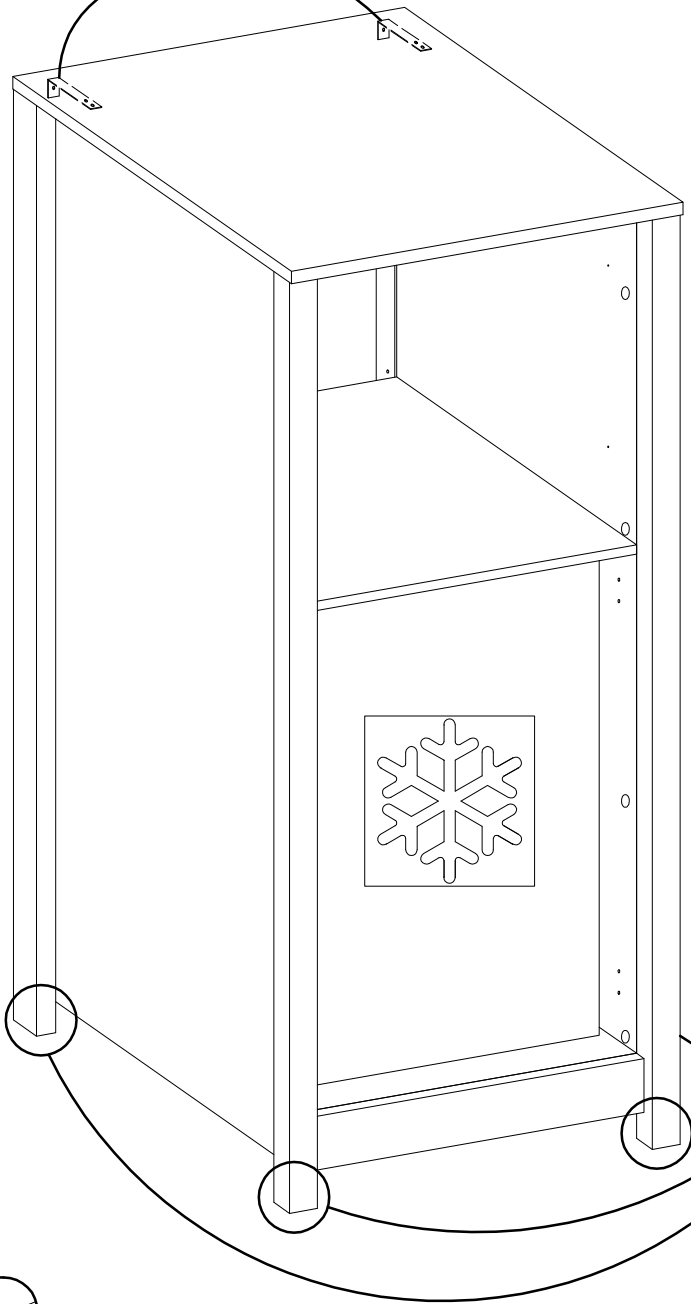
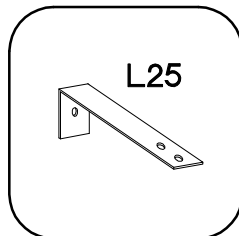
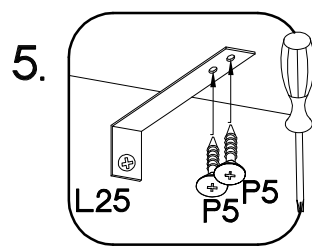
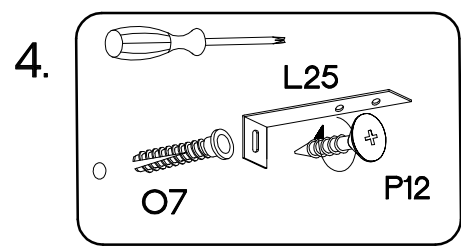
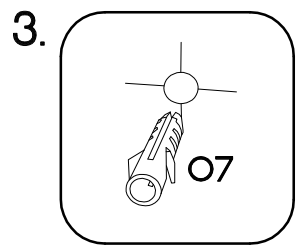
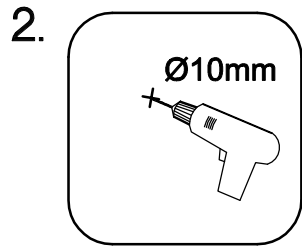
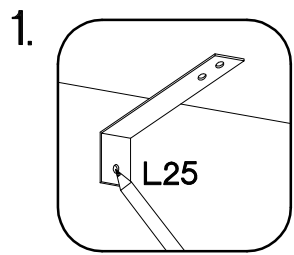

9

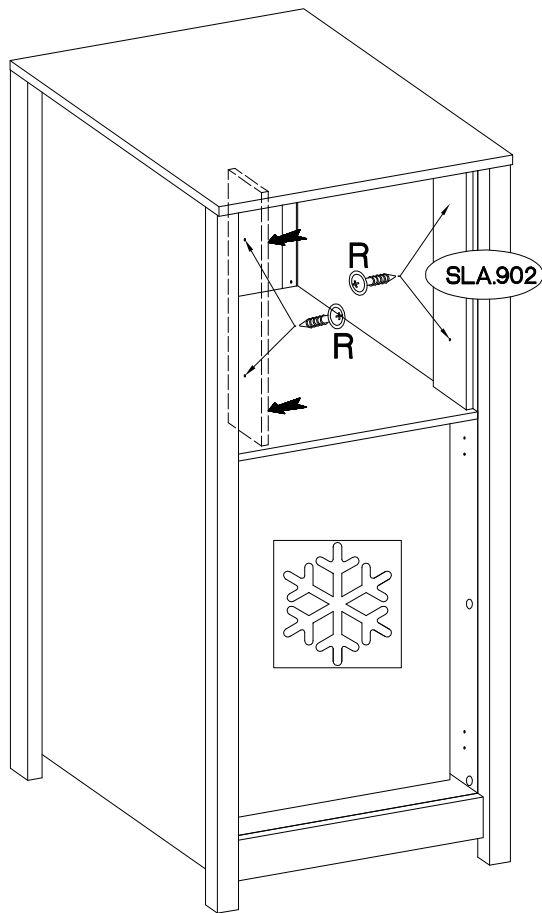

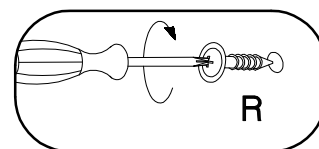
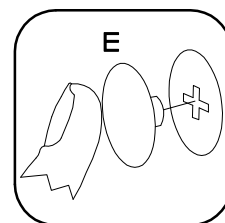

$\pm 4.0 \times 25 \text{mm}$  <b>R</b> <b>4</b>	 <b>E</b> <b>6</b>
---	--------------------------

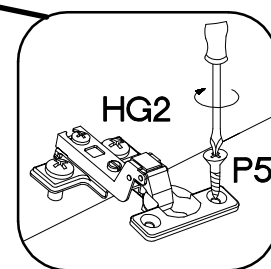
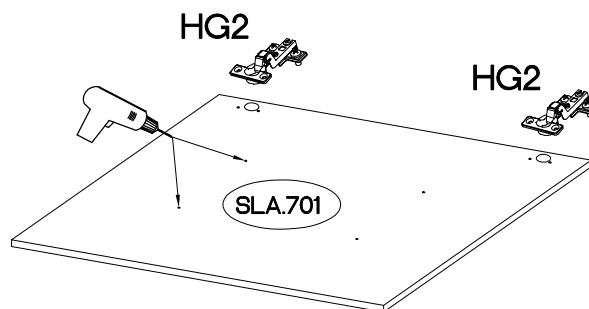
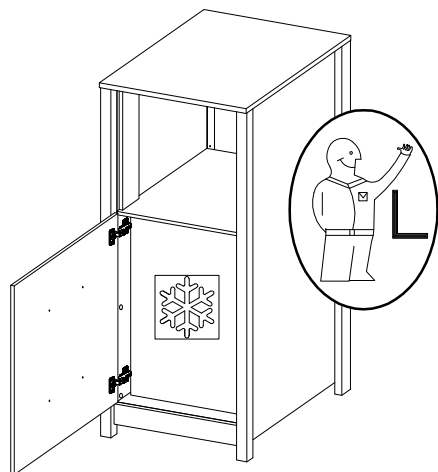
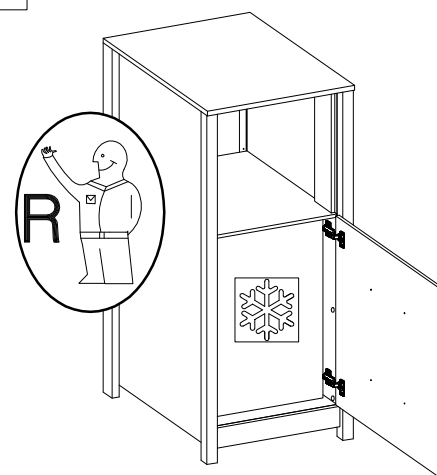
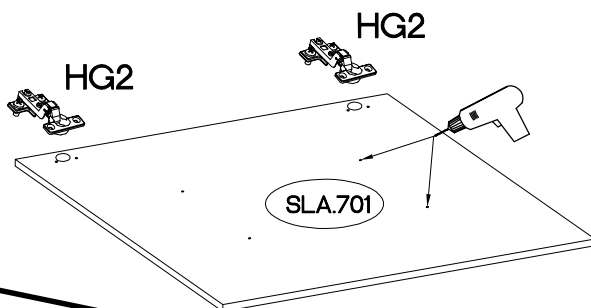
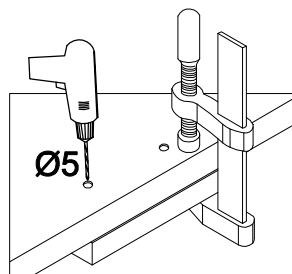
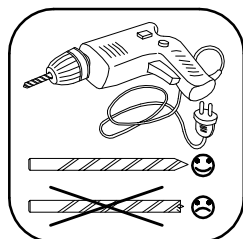

10

$\pm 35/16 \text{mm}$  <b>[CD]</b> <b>HG2</b> <b>2</b>	$\pm 3.5 \times 13 \text{mm}$  <b>P5</b> <b>4</b>
--	--



M4x22mm	L=192mm
	
U	S
2	1

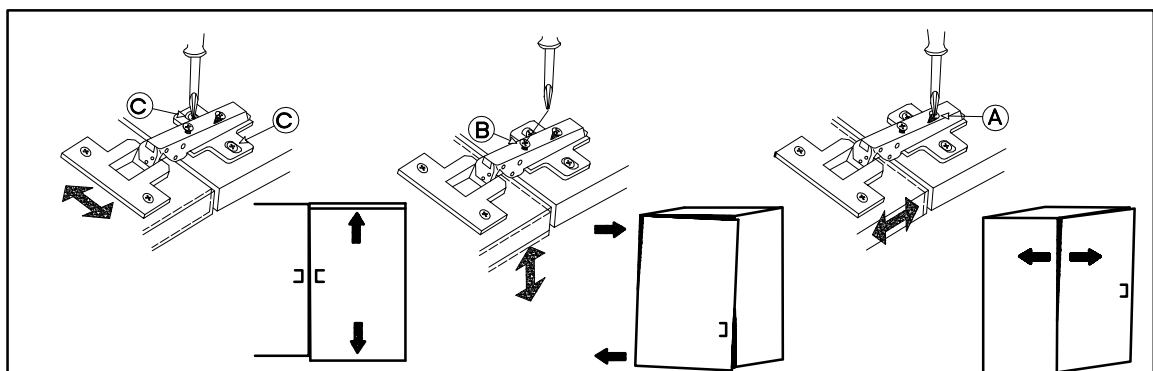
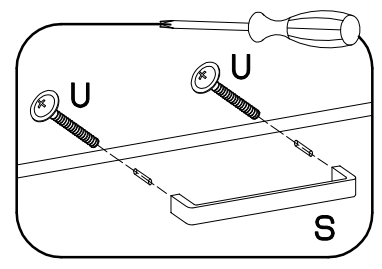
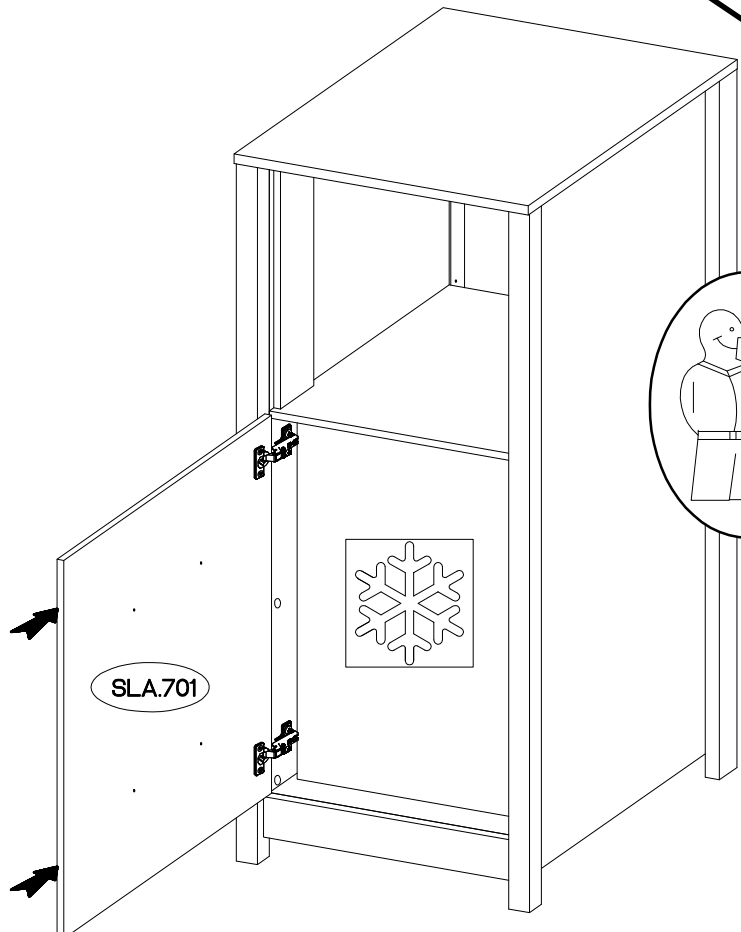
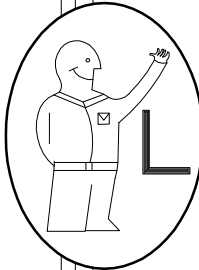
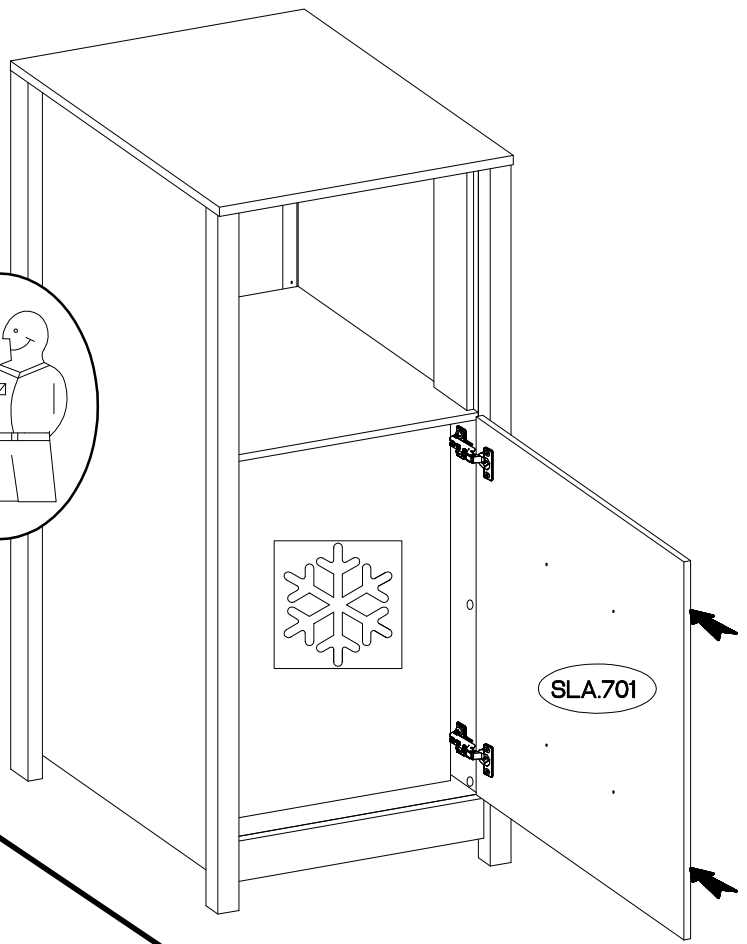
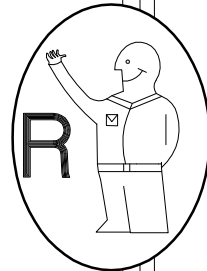





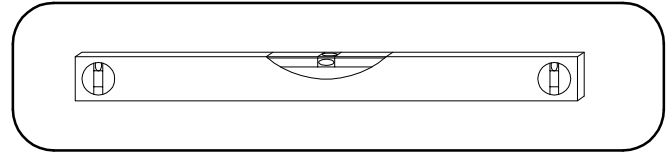
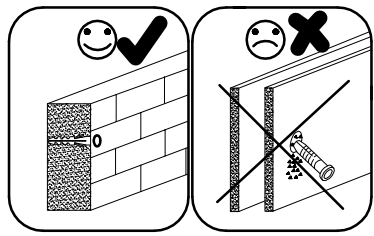
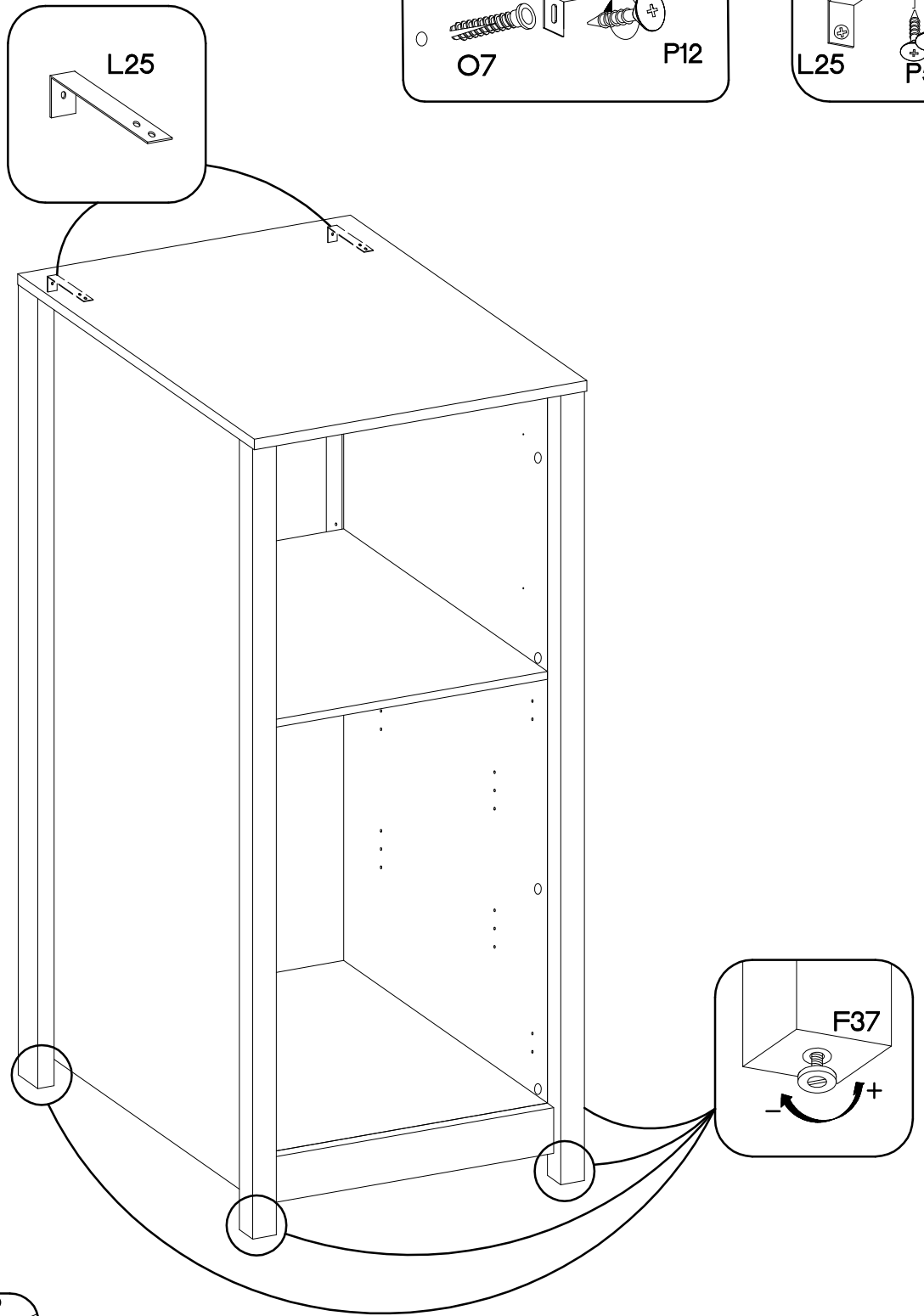

±5.0x60mm P12 2	120x30x15mm L25 2
±3.5x13mm P5 4	±10x50mm O7 2

- 1.
- 2.
- 3.
- 4.
- 5.

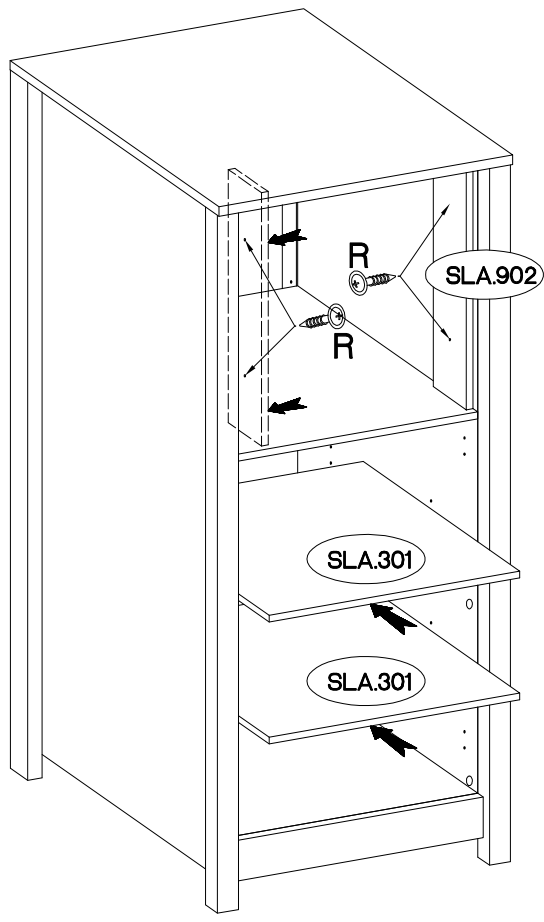



14



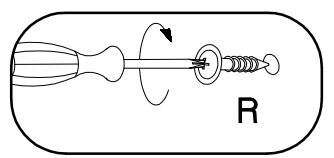
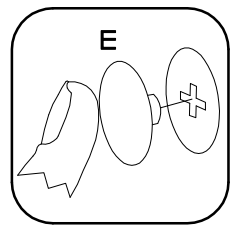
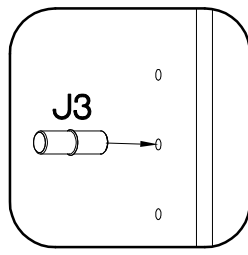

$\pm 4.0 \times 25 \text{mm}$  R 4	$\pm 5/16 \text{mm}$  J3 8	 E 10
--	--	--

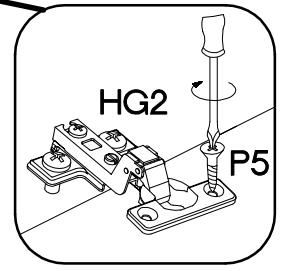
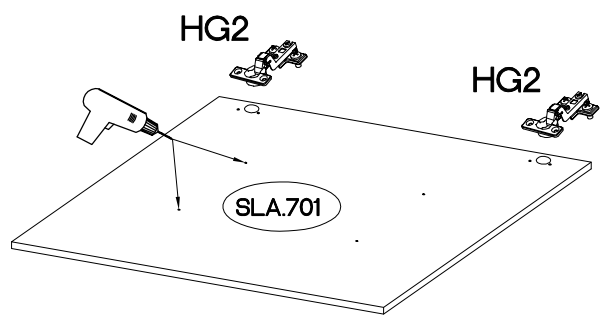
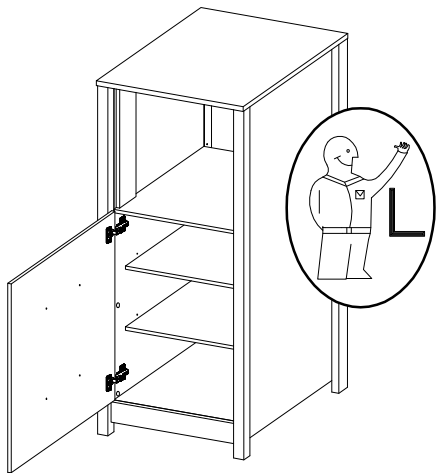
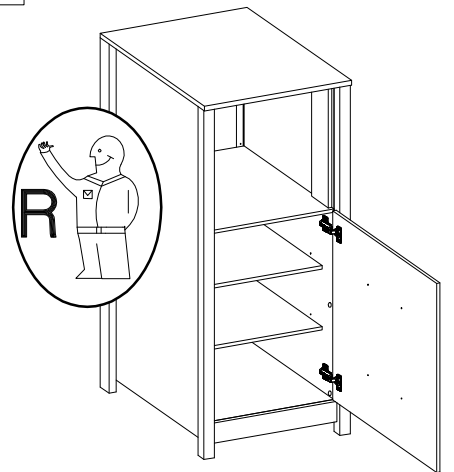
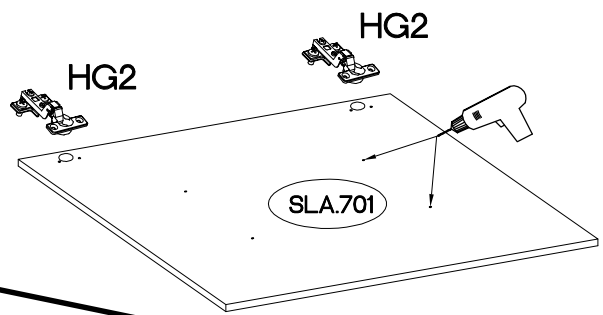
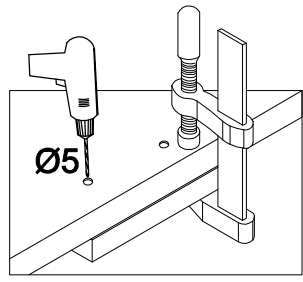
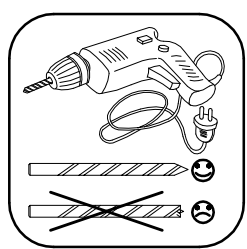

15

$\pm 35/16 \text{mm}$  [CD] HG2 2	$\pm 3.5 \times 13 \text{mm}$  P5 4
---	---



M4x22mm	L=192mm
	
U	S
2	1

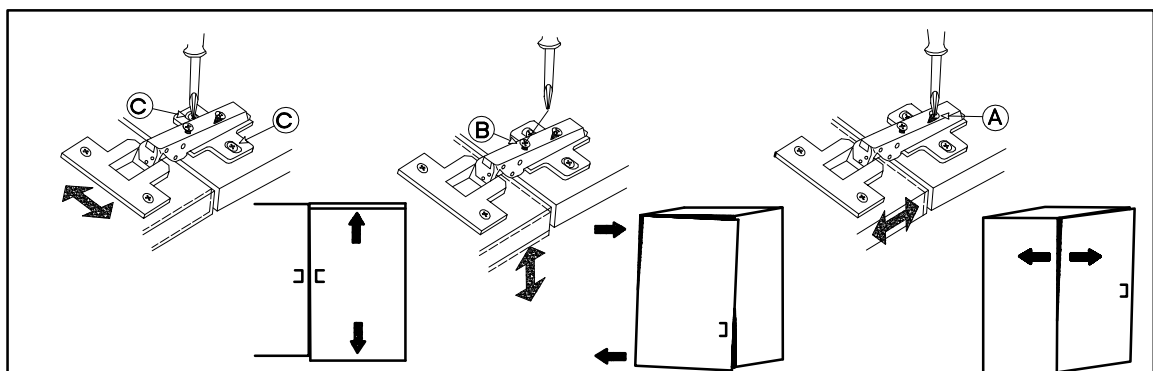
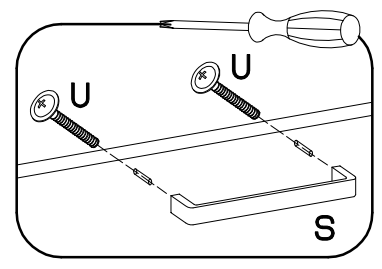
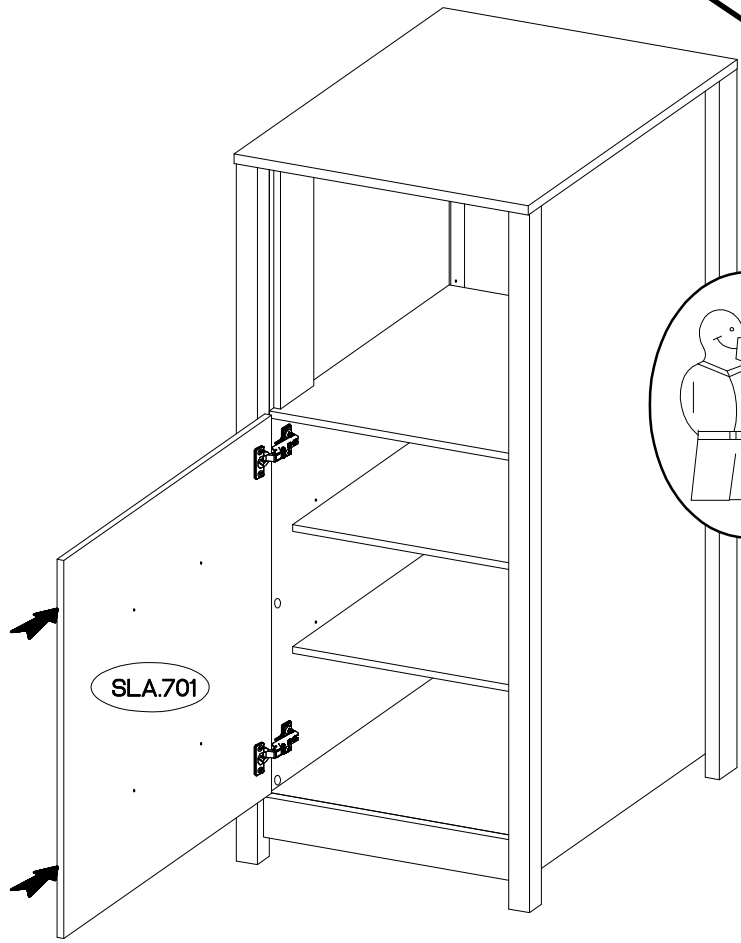
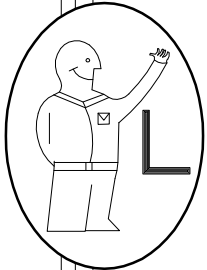
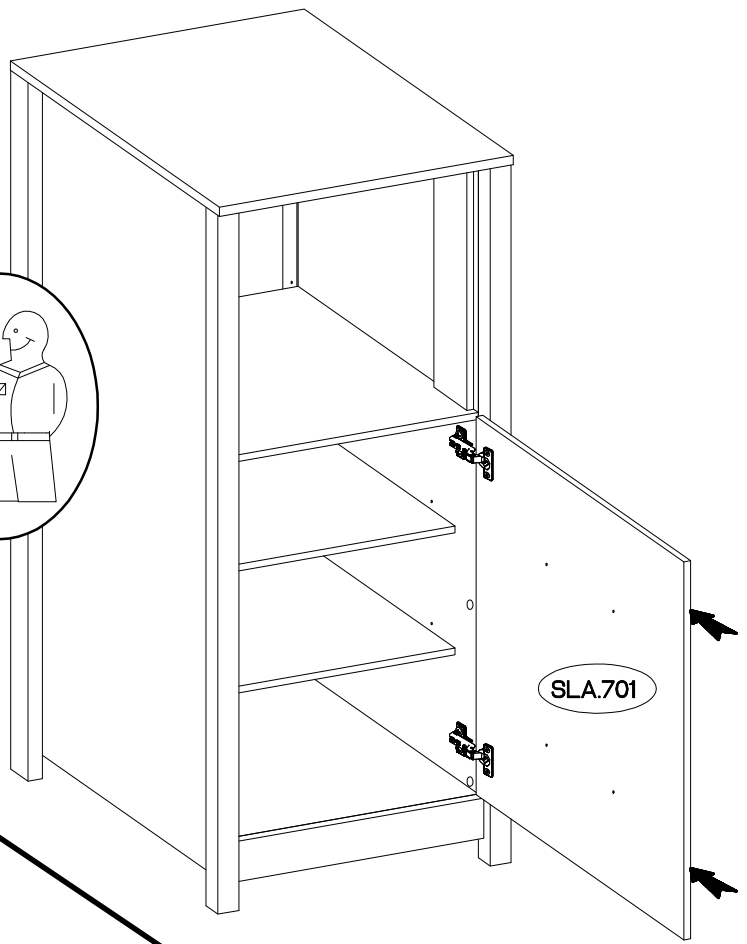
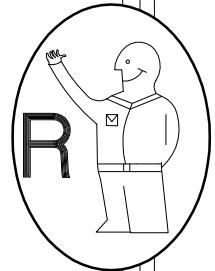

# BEANSTANDUNG / COMPLAINT / RÉCLAMATION

Fax + 33 3 88 05 55 68

Finden Sie dieses Formular online / Find this form online / Retrouvez ce formulaire en ligne :



[www.interlink-sas.de/Service/Privatkunden-service/Kundendienstsanfrage/](http://www.interlink-sas.de/Service/Privatkunden-service/Kundendienstsanfrage/)

Herr / Mr. / Monsieur     Frau / Mrs. / Madame

Vorname / First name / Prénom .....

Nachname / Last name / Nom .....

Straße, Hausnummer / Street, Street Number / Numéro, Rue .....

PLZ / Postal Code / Code Postal.....

Ort / City / Ville .....

Land / Country / Pays.....

Tel. ....

Mail.....



**Machen Sie es sich einfach!**  
Scannen Sie mich und füllen Sie das Formular online aus

**Make it easy!**  
Scan me and fill out the form online

**Simplifiez-vous la vie!**  
Scannez-moi et remplissez le formulaire en ligne

## 1 ARTIKELBEZEICHNUNG / ARTICLE NAME / NOM DU PRODUIT

2 REF. / ART. NR

3 ORDER

Bei welchem Vertriebspartner/Händler wurde der Artikel erworben?  
What sales partner/dealer was the article purchased from?  
Après de quel distributeur ou magasin l'article a-t-il été acheté ?

.....  
.....



Bitte wenn möglich Bilder senden  
Please send uns pictures if possible  
Merci de nous envoyer vos photos  
**5 MB max.**

Für Ihre Mithilfe zur schnellen Bearbeitung Ihrer Reklamation möchten wir uns sehr bedanken.  
Thank you very much for assisting us in processing you complaint without delay.  
Nous tenons à vous remercier pour votre collaboration au traitement rapide votre réclamation.

Auf der Montage Anleitung / On the assembling instruction / Sur la notice de montage

### 1 "PASADENA "

Montage Anleitung / Notice de Montage / Assembling Instruction

2 ART. NR: 52 28 71 08

EAN NO.: 40 10 340 87 10 82

3 ORDER: 16916



## GRUND DER BEANSTANDUNG / REASON FOR COMPLAINT / MOTIF DE LA RÉCLAMATION

**FEHLENDES TEIL / MISSING PART / PIÈCE MANQUANTE**

Referenz des Bauteils / Reference of the component / Référence de la pièce

**BESCHÄDIGTES TEIL / DAMAGE PART / PIÈCE DÉFECTUEUSE**

Referenz des Bauteils / Reference of the component / Référence de la pièce

**SONSTIGE / OTHER / AUTRE**

In der Montage Anleitung  
In the assembling instruction  
Dans la notice de montage

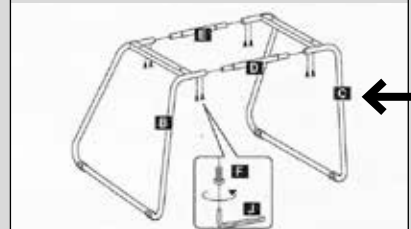

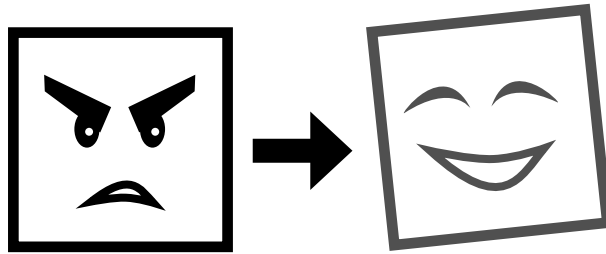

# BEANSTANDUNG RECLAMATION COMPLAINT RECLAMO



**Machen Sie  
es sich einfach!**

Scannen Sie mich und füllen Sie  
das Beanstandungsformular  
online aus



**Simplifiez-vous  
la vie !**

Scannez-moi et remplissez  
le formulaire de réclamation  
en ligne



**Make it easy!**

Scan me and fill out  
the complaint form  
online



**Falla Facile!**

Scansionami e  
compila il modulo  
onlin



*Scan me*

[www.interlink-sas.de/Service/Privatkundenservice/Kundendienstanfrage/](https://www.interlink-sas.de/Service/Privatkundenservice/Kundendienstanfrage/)

Inter Link traite les données recueillies pour donner suite à votre réclamation et l'amélioration des produits. Pour en savoir plus sur la gestion de vos données personnelles et pour exercer vos droits, reportez-vous à l'information communiquée sur notre site internet à l'adresse suivante : <https://www.interlink-sas.de/fr/Service/Service-clients-particuliers/Demande-service-client/>

INTER LINK, Z. A. du Niederwald  
F-67470 Seltz [www.interlink-sas.com](http://www.interlink-sas.com)

Inter Link®

# WICHTIG • IMPORTANT!

Liebe Kundin, lieber Kunde!

Vielen Dank, dass Sie ein Produkt von Inter Link SA gekauft haben. Jedes Möbel wird mehrfach auf einwandfreien Zustand kontrolliert. Trotzdem kann es vorkommen, dass hin und wieder etwas nicht zu Ihrer Zufriedenheit ist (siehe hierzu auch Rückseite). In einem solchen Fall teilen Sie uns den Grund Ihrer Beanstandung, die Artikel-Nummer und die untenstehende 4-stellige Order-Nummer für das gekaufte Produkt mit. Sie können Ihre Beanstandungen auch auf der Montageanleitung einzeichnen und an uns senden oder faxen.

**Bitte geben Sie in jedem Fall die Order-Nummer an, sonst kann Ihre Reklamation nicht bearbeitet werden.**  
Wir danken Ihnen für Ihr Verständnis und wünschen Ihnen viel Freude mit Ihrem neuen Möbel!

Dear customer!

Thank you for buying a product from Inter Link SA. This piece of furniture has been checked several times for its faultlessness. Unfortunately it is still possible that every now and then something is not quite to your satisfaction (please also see the back-side of this page). In that case you have to state the article number and the four digit order number of the purchased product which you can see at the bottom of this page additionally to your complaint. You can also mark the fault on the assembly instructions and send it to us by fax or post.

**Please make sure that you always state the order number, otherwise we cannot process your complaint.**  
We thank you for your understanding and hope you will enjoy your piece of furniture.

Chère cliente, cher client!

Merci d'avoir acheté un produit de notre gamme. Ce meuble a été plusieurs fois contrôlé lors de sa fabrication. Si toutefois ce produit ne vous donnait pas entière satisfaction, nous vous serions reconnaissant de bien vouloir spécifier, lors de votre réclamation, la référence de l'article et le numéro de commande (Order n°) inscrit en bas de cette page et indiquer le numéro de la pièce défectueuse en vous aidant pour cela de la notice de montage.

Remettez ce document au point de vente où vous avez effectué votre achat qui transmettra.

**N'omettez pas d'indiquer le numéro d'ordre ci dessous, indispensable au bon traitement de votre réclamation.**  
Nous vous remercions pour votre compréhension.



**Inter Link SA**  
Z. A. du Niederwald  
F-67470 Seltz  
Frankreich/France

International:  
Telefon: (0033) 3 88 05 55 50  
Telefax: (0033) 3 88 05 55 68

National:  
Téléphone 03.88.05.55.59  
Téléphone 03.88.05.55.77  
Télécopie 03.88.05.55.79

e-mail:  
service@interlink-sa.com  
[www.interlink-sa.com](http://www.interlink-sa.com)



Wir möchten,  
dass **Sie** zufrieden sind!

We want **YOU** to be  
pleased with our quality!

Nous voulons **VOUS**  
donner entière satisfaction !

Order-Nr./Order no./Commande no.

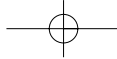

## Holz lebt ... — Hinweise zu Ihrem Produkt!

Sie haben sich mit dem Kauf für ein Möbel aus Massivholz, ein Naturprodukt, entschieden. Die Echtheit des Holzes erkennen Sie an der unterschiedlichen Maserung - den so genannten „Jahresringen“ - und den Ästen. Die Jahresringe, teilweise mit ihrer rötlich-braunen Färbung zeigen das Alter des Baumes. Die Natur des Holzes und Ihre vorteilhaften Eigenschaften geben jedem einzelnen Möbelstück Ihren ganz „persönlichen Charakter“ und verleihen jedem Möbel die Bezeichnung „Unikat“.

### Auch andere Eigenschaften sollten Ihnen bekannt sein:

Holz kann Wasser und Wärme aufnehmen und auch wieder abgeben, das bedeutet, es passt sich dem Umgebungs-Klima an. Bei feuchtem Klima wird Wasser aufgenommen - das bewirkt, dass das Holz „wächst“ (quillt). Bei sehr trockenem Klima wird Wasser abgegeben und das Holz „schrumpft“ (schrumpft). Dieses „Arbeiten“ des Holzes ist naturbedingt und kann Maßveränderungen herbeiführen. Trotz sorgfältiger Qualitäts-Sortierung, können durch nicht sichtbare Verwachsungen und unterschiedliche naturbedingte Maserungsverläufe, Spannungen auftreten, die ein „Verziehen“ (Propeller) bewirken. Bekommen Teile nur einseitig Feuchtigkeit oder Wärme, dies kann auch während des Transportes auftreten, so hat dies zur Folge, dass Teile „schüsseln“ (hohl oder bauchig werden). Um dieses „Schüsseln“ wieder rückgängig zu machen, stellen Sie die hohlen Seiten einige Tage gegeneinander, so dass bei normalem Raumklima die Rückbildung erfolgen kann. Beim oben erwähnten „Arbeiten“ können auch kleine Risse, leichte Unebenheiten, leichte Aufrauungen auf der Oberfläche und an den Kanten auftreten. Äste und Verwachsungen, unterschiedlich starke Maserungen, und Farb-/Struktur-Unterschiede sind demzufolge positive Unikats-Merkmale eines völlig natürlich gewachsenen Werkstoffes und stellen keine Beanstandungen/Reklamationen dar.

Um die Oberfläche des Holzes zu schützen und das natürliche Aussehen zu erhalten, wurde sie mit einem klaren Schutzlack überzogen. Sofern Sie ein gebeiztes Möbel erworben haben, sind eventuelle Farbschwankungen naturbedingt, und verleihen dem naturbedingten Unikat seine ganz persönliche Note. Massivholz nimmt Beize je nach Holzmaserung unterschiedlich stark auf. Diese natürlichen Abweichungen in der Beiztonintensität stellen keine Beanstandung dar.

Um die Auswirkungen der aufgeführten Eigenschaften so gering wie möglich zu halten, achten Sie darauf, dass die Möbelteile immer in einem normalen Raumklima (ca. 20 - 22 °C und 40 - 50 % Luftfeuchtigkeit) gelagert oder aufgestellt sind.

### Pflegehinweis:

Holz, Glas, Stahlmöbel oder MDF und beschichtete Oberflächen: Pflegen Sie Ihr Möbel am besten mit einem leicht angefeuchtetem Staubtuch oder mit etwas Möbelpolitur (im Handel überall erhältlich und beachten Sie unbedingt die Gebrauchsanweisungen dazu). Wenn Sie Ihr Möbel gelegentlich feucht abwischen, vergessen Sie bitte nicht mit einem trockenen Tuch nach zu reiben.

Stahlmöbel: Das Metall ist in der Oberfläche mit einer Schutzlackierung versehen. Diese kann durch die maschinell bedingte Produktion evtl. kleine Farbdifferenzen, Wolken, Flecken aufweisen, welche keinen Reklamationsgrund darstellen. Falls durch den Transport evtl. einige Metallteile etwas verbogen sein sollten, können Sie diese vorsichtig in die Ursprungslage zurückbiegen. Die Schrauben wollen Sie bitte nicht überdrehen und von Zeit zu Zeit nachziehen.

MDF und beschichtete Oberflächen: MDF besteht aus Holzfasern. Die beschichtete Oberfläche bitte nicht mit Messer oder spitzen Gegenständen bearbeiten, da hier Schäden entstehen können. Dadurch verursachte Schäden sind keine Reklamationsgründe.

Sollten evtl. durch die maschinelle Bearbeitung der beschichteten Kanten oder Oberflächen, die Kanten oder Ecken etwas scharfkantig sein, können sie diese mit einem handelsüblichen Sand-Schleifpapier nachschleifen. Gehen sie jedoch dabei sorgfältig und vorsichtig vor, damit nicht zu viel Material entfernt wird.

**Wir wünschen Ihnen viel Freude mit Ihrem neuen Möbel  
Ihr Qualitätssicherungsteam bei Inter Link SA**

## Le bois, une matière vivante... Indications sur votre produit :

Avec l'achat de ce meuble en bois massif, vous avez fait l'acquisition d'un produit naturel. Vous reconnaissez l'authenticité du bois grâce aux différents veines appelés aussi cernes, ainsi qu'aux nœuds. Les cernes partiellement teintés de rouge-brun, indiquent l'âge de l'arbre. La nature du bois et ses propriétés avantageuses donnent à chaque meuble un caractère personnel et prêtent ainsi la désignation de „pièce unique“ à chacun d'eux.

### Mais bien d'autres éléments sont à porter à votre connaissance :

Le bois peut absorber l'eau et la chaleur et les rejeter, ce qui signifie qu'il s'adapte à tous les climats. Dans un milieu humide, il absorbe l'humidité ce qui cause des variations dimensionnelles (gonflement) du bois. Dans un milieu sec, le bois s'assèche et entraîne des variations dimensionnelles inverses. Ce „travail“ du bois est un phénomène naturel mais peut ainsi provoquer des modifications de mesures. Malgré un tri soigneux et qualitatif, des cicatrices non visibles et des cours de veines différents dus aux effets naturels du temps peuvent provoquer des fissures ou éclatements (souvent en forme d'étoile). Une exposition unilatérale à l'humidité ou la chaleur peut causer faire goger ou voiler le bois. Si certaines pièces devaient être goger ou voilé, il vous suffit de les poser l'une contre l'autre pendant quelques temps afin qu'elles reprennent leur forme initiale. Dans le „travail“ du bois décrit précédemment, de petites fissures, inégalités ou rugosités peuvent également apparaître sur les parties extérieures de votre meuble. Nœuds, cicatrices, cernes de structure ou de couleur différentes sont considérés comme les signes particuliers d'une matière totalement naturelle et ne peuvent par conséquent être sujet à réclamation.

Pour protéger la surface du bois et conserver son aspect naturel, celle-ci est recouverte d'un vernis de protection, transparent. Dans la mesure où vous avez acquis un meuble de teinte miel, des variations de couleurs sont dues aux effets naturels du bois, ce qui accentue sa note personnelle de pièce unique. Le bois massif absorbe plus ou moins fortement la teinture ce qui ne peut être un motif de réclamation. Afin de réduire au maximum les conséquences citées ci-dessus, veuillez à ce que votre meubles soient entreposés dans un climat ambiant normal d'environ 20-22°C et d'une hygrométrie de 40 à 50 %.

### Conseils d'entretien

Pour tous les meubles en bois, métal, MDF ou panneaux de particules : Nettoyer vos meubles avec un chiffon doux humide ou du produit à bois (disponible dans les magasins spécialisés - lire attentivement la notice d'emploi avant utilisation). Repasser impérativement un chiffon doux et sec.

Meubles en métal : la surface du métal est recouverte d'un laquage de protection. De par la fabrication mécanique, des nuances de teintes peuvent apparaître, celles-ci ne peuvent être prise en compte comme motif de réclamation. Ne pas faire foirer les vis, il est préférable de les resserrer de temps en temps.

Meubles en MDF ou panneaux de particules : les meubles en MDF se composent de fibres de bois recouvertes d'un film. Il ne faut en aucun cas utiliser d'objet pointu ou tranchant sur ces surfaces. Les dommages dus à ces effets ne pourront faire l'objet de réclamations.

Si toutefois les arêtes devaient être vives, il suffit de les poncer légèrement avec du papier émeri fin. Mieux vaut renouveler l'action une seconde fois, de façon à ne pas endommager le meuble.

**Nous vous souhaitons beaucoup de plaisir au montage de votre nouveau meuble.  
Cordialement, l'équipe du service qualité chez Inter Link S.A.**

## Wood lives ... Important information on your product!

You have decided to buy a furniture of solid wood – a natural product. You can observe the wood genuineness through the knots and the several grains, which are called „Years Rings“. The „Years Rings“ which partially have a red-brownish colour show you the age of a tree. The wood nature and its advantageous features lend each piece of furniture a connotation of an uniqueness.

### We would like to inform you about further characteristics of the wood:

Wood can retain and release water and heat - what means that the wood modifies itself according to the environment conditions and weather. If the weather is humid the wood absorbs water and expands. On the contrary, if the weather is dry, the wood releases water and it shrinks automatically. The alterations in the wood depend on the climate and can affect the dimensions of your piece of furniture. Although the woods quality is chosen carefully, the alterations in the wood can lead to strains due to invisible connotation or natural grown runs of grains. If a piece of furniture is exposed to humidity on one of its sides (what can happen during transport as well) this side can warp becoming a concave or convex surface. To obtain the usual and correct form of your piece of furniture, you can set convex sides against each other for some days and store them in a room with room normal room temperature and humidity. The wood will recede and obtain the former shape again. If your piece of furniture has expanded or shrunk for one of the reasons mentioned above, some small cracks, light scratches or unevenness can appear on the surface or edges of the your piece of furniture. Nodes, intergrowths, different runs of grains, colour, and variety of composition are signs for unique features of a natural grown material. This should be no reason for an objections or complaints.

Your piece of furniture is covered with a light varnish layer used to protect the wooden surface and its natural appearance. Since you have bought a stained piece of furniture you should be aware of eventual colour variation caused by the nature of the wood. Solid wood absorbs the stain according to its grains and therefore you will have different colours in your piece of furniture, what should not be a cause of objections or complaints.

To reduce the effect of the characteristics listed, you should pay attention to the room temperature and humidity. Solid wood furniture have to be stored or kept in a room with a temperature between 20 - 22°C and air humidity between 40 - 50 %.

### Maintenance advice:

You should clean your piece of furniture with a moistened cloth or with special furniture polish available in supermarkets or specialized stores. Using a furniture polish pay attention to its instructions for use. Please do not forget to wipe your piece of furniture up with a dry cloth.

**We wish you a lot of joy and pleasure with your new piece of furniture.  
Your quality assurance team at Interlink**

