

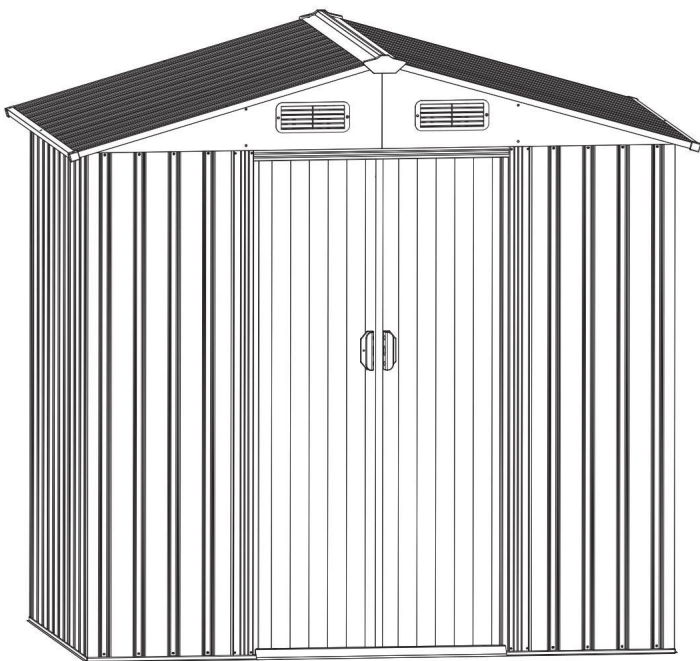

SK



Záhradný domček BRUK 3



[www.DEUBAXX.de](http://www.DEUBAXX.de)

# POKYNY

Vážený zákazník,

Ďakujeme, že ste si vybrali náš produkt. Zakúpením jedného z našich značkových produktov ste urobili vynikajúcu voľbu. Aby sme splnili požadované vysoké štandardy kvality, naše produkty prechádzajú pravidelnými kontrolami a samozrejme vždy spĺňajú prísne požiadavky Európskej únie.



**DÔLEŽITÉ, USCHOVAJTE NA BUDÚCE POUŽITIE: POZORNE SI PREČÍTAJTE!**

Pred prvým použitím si pozorne prečítajte tento návod. Uschovajte si ho pre budúce použitie. Pokiaľ budete výrobok odovzdávať niekomu inému, nezabudnite k nemu priložiť aj tento návod.



**VAROVANIE! POTENCIÁLNE NEBEZPEČENSTVO!**

Dodržiujte prosím bezpečnostné pokyny a montážne pokyny, aby ste predišli riziku zranenia alebo poškodenia výrobku.



**NEBEZPEČENSTVO UTRPENIA!**

**Uchovávajte malé diely a obalový materiál mimo dosahu detí!**



**ÚPRAVY VÝROBKU** Nikdy nevykonávajte žiadne úpravy

produktu! Úpravy zrušia platnosť záruky a produkt sa môže stať nebezpečným, alebo v najhoršom prípade dokonca nebezpečným.

**VŠEOBECNÉ POKYNY** Skôr ako začnete s montážou, zoznámte

sa s miestnymi predpismi a vyhláškami. Vyberte pevný a rovný povrch pre základ. Dom montujte iba za suchého a pekného počasia.

Nemontujte za silného vetra!

Pokiaľ je to možné, zostavte prístrešok v troch alebo viacerých ľudoch spoločne. Inak by mohlo dôjsť k poškodeniu majetku alebo dokonca k zraneniu. • Vyberte miesto, ktoré okolo prístrešku poskytuje dostatok priestoru na pohodlnú prácu.

- **Nez začnete so stavbou záhradného domčeka, uistite sa, že máte potrebné materiály.** mať dobrý základ budovy.
- Pred zaistením správnej montáže presne dodržujte kroky uvedené v návode. zaistiť.
- Pred zahájením montáže sa uistite, že sú prítomné všetky diely. • Uistite sa, že základový rám leží vodorovne na zemi. • Základ musí byť rovný. Pokiaľ je terén nerovný, zarovnajte ho. • Nepokúšajte sa zostaviť prístrešok za veterného počasia, pretože

Existuje riziko poškodenia panelov alebo zranení osôb.

- Prístrešok musí byť postavený na pevnom, rovnom a vodorovnom základe. Ako podlahová konštrukcia sa odporúča železobetónový základ alebo veľké betónové dosky. Rozmery základu by mali byť aspoň o 10 cm väčšie ako

Rozmery prístrešku. Výber a konštrukcia základov nie sú kryté zárukou. Spoločnosť nepreberá žiadnu zodpovednosť za výber a kvalitu základov.

- Pre železobetónový základ pripravte prvú vrstvu z kameňov alebo štrku.

Základ by mal byť hrubý aspoň 10 cm. Nechajte betón stuhnúť.

Sušte aspoň 48 hodín.

- Základy je možné postaviť aj z tehál, kamenných blokov alebo betónových podstavcov. • Prístrešok nie je určený na priamu stavbu na trávniku. • Váš prístrešok musí byť bezpečne ukotvený k základom, aby nedošlo k poškodeniu silným vetrom. Kotvy nie sú súčasťou dodávky! • V prístrešku neskladujte chemikálie. Horľavé, ostré alebo žieravé materiály musia byť skladované vo vzduchotesných a vhodne schválených nádobách.

- Vrstva snehu väčšia ako 10 cm môže byť nebezpečná! • VAROVANIE! Nechodte na strechu! Nebezpečenstvo zrútenia!

- Vyhýbajte sa čo najviac previsnutým stromom, pretože padajúce lístie vyžaduje pravidelné čistenie a lámanie vetiev predstavuje nebezpečenstvo.

- Malé stromy, kríky alebo ploty v okolí môžu byť užitočné ako vetrolamy.

- VAROVANIE! Počas montáže držte malé deti v dostatočnej vzdialenosti, nebezpečenstvo zranenia! •

Poznámka: Na montáž je potrebný vhodný krížový skrutkovač, akumulátorová vŕtačka, zvinovací meter, nôž, rebrik, vodováha a ochranné rukavice.

URČENÉ POUŽITIE Záhradný domček je určený na uloženie

záhradného náradia, bicyklov a rekreačného vybavenia. Nie je vhodný na uloženie nebezpečných materiálov ani na ubytovanie osôb či zvierat. Používajte výrobok iba na jeho určený účel. Výrobca nepreberá žiadnu zodpovednosť za škody vzniknuté v dôsledku nesprávneho použitia. Akákoľvek úprava výrobku môže ohroziť bezpečnosť, vytvoriť nebezpečenstvo a viesť k zrušeniu platnosti záruky.

## Len na domáce použitie a nie na komerčné účely.

### POKYNY NA VYBALENIE

Otvorte škatuľu a vyberte všetky diely a komponenty sady a položte ich na škatuľu alebo iný čistý povrch. Tým ochránite svoj nový výrobok. Po vybalení skontrolujte, či je výrobok kompletný a či nie je poškodený. Reklamácia uplatnená po vybalení nemôžu byť akceptované.

### VÝBER LOKALITY

Než začnete s montážou, zoznámte sa s miestnymi predpismi a vyhláškami. Pri výbere najvhodnejšieho miesta pre prístrešok zaistite stabilný a rovný povrch a rozhodne sa vyhnite exponovanému miestu, kde by prístrešok stál úplne nechránený! Je nutné zaistiť určitú ochranu pred búrkami a silnými nárazmi vetra. V opačnom prípade by sa prístrešok poškodil, pokiaľ by zostal exponovaný.



#### KONŠTRUKCIA



Postupujte podľa diagramov popisujúcich kroky montáže.

Počas montáže vždy používajte ochranné rukavice, dlhé rukávy a ochranu očí.

Niektoré diely môžu mať ostré hrany a spôsobiť zranenie! • Uistite sa, že deň, ktorý si zvolíte pre montáž, je

suchý a

Stavenisko je

bezvetrie. • Udržujte deti a domáce zvieratá v dostatočnej vzdialenosti od montážnej plochy. • Pred montážou odstráňte ochranné fólie. • U

vopred natretých povrchov používajte iba skrutky s plastovými podložkami. • Ak používate rebrík, uistite sa, že je stabilný. Nikdy nepoužívajte plnú silu.

Nezaťažujte akúkoľvek časť strechy alebo prístrešku.

- Upravte krútiaci moment akumulátorového skrutkovača, aby ste nepoškodili kovové časti. vyhnúť sa.

#### POKYNY PRE ÚDRŽBU A STAROSTLIVOSŤ

Odporúčame pod celú inštalačnú plochu umiestniť plastovú fóliu alebo parozábranu.

Dobré vetranie znižuje potenciálne poškodenie skladovaných predmetov spôsobené vlhkosťou prenikajúcou zo zeme a minimalizuje kondenzáciu vo vnútri. Všetky spoje môžete dodatočne utesniť silikónom. Pre dlhú životnosť by ste mali kôľhu pravidelne čistiť. Nepoužívajte agresívne čistiace prostriedky.

Škrabance čo najskôr opravte vhodnou farbou. Dôkladne očistite postihnuté miesto a potom naneste farbu. Pokiaľ toto zanedbáte a škrabaneц poškodí náter, podporí to tvorbu hrdze. Udržujte strechu bez lístia a snehu. Silný sneh na streche môže poškodiť dom. Udržujte dvere a kolajnice čo najčistejšie. Kolajnice a valčeky pravidelne čistite a striekajte ich silikónovým sprejom. Po použití bránu vždy zatvorte, aby ste zabránili poškodeniu vetrom.

#### TECHNICKÉ ÚDAJE

Článok	990739, 990741
Rozmery (Š x V x H)	187 × 196 × 132 cm

#### LIKVIDÁCIA

Na konci dlhlej životnosti vášho produktu zaistite, aby boli cenné suroviny riadne zlikvidované, aby mohli byť recyklované. Ak si nie ste istí, ako najlepšie postupovať, vaša miestna spoločnosť zaoberajúca sa likvidáciou odpadu alebo recyklačné stredisko vám rady pomôžu.







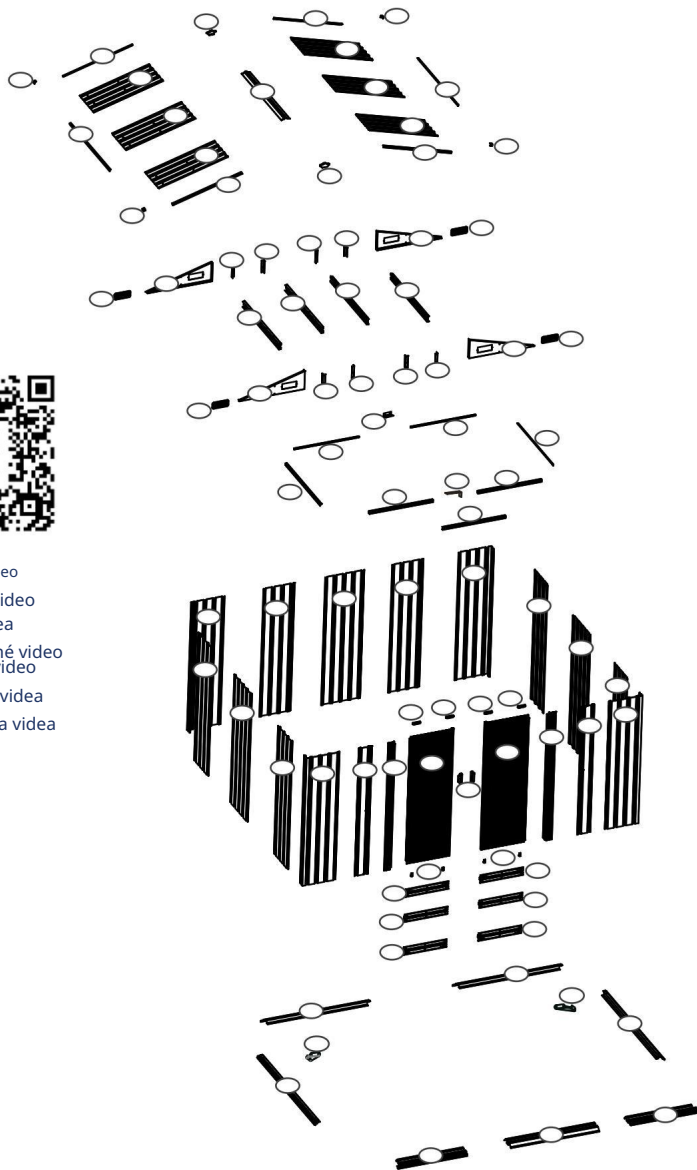





EXPLODED VIEW / VUE ÉCLATÉE / VISTA ESPLOSA /  
ESQUEMA DEL PRODUCTO / EXPLOSIETEKENING / RYSUNIEK WYBUHU















- Montážne video
- Montážne video
- Montáž videa
- Konfiguračné video
- Inštaláčn video
- Nastavenie videa
- Konfigurácia videa

























ZOZNAM DIELOV / ZOZNAM DIELOV / LISTE DES PIÈCES / ELENCO DELLE PARTI / LISTA DE PIEZAS /  
 LIJST VAN ONDERDELEN / LISTA CZĘŚCI  
 KARTON 1/2

NO	PART	QTY
19		1
P2		4
P3		3
P5		2
P6		2
P7		1
P8		1
21L		2
21R		2
GB		2
GC		4
GD		4
JM5		2
GLV02		2

NO	PART	QTY
27		2
25L		1
25R		1
D1		1
D2		1
G2		4
GE		2
GF		4
F1		220
F2		94
F3		8
S1		142
S2		180

## KARTON 2/2

ZIADNY	ČASŤ	MNOŽSTVO
1		2
3L		1
3R		1
4L		1
4R		1
5		1
7		1
8		1
9		1
11		1
17		2
18 rokov		2
20		4
GJ		2
K.		1

ZIADNY	ČASŤ	MNOŽSTVO
10 litrov		1
10R		1
13		2
14		2
B1		2
B2		2
B3		4
P1A		6
P4A		2
6		1
15		2
W2		2
V1		2
W3		3

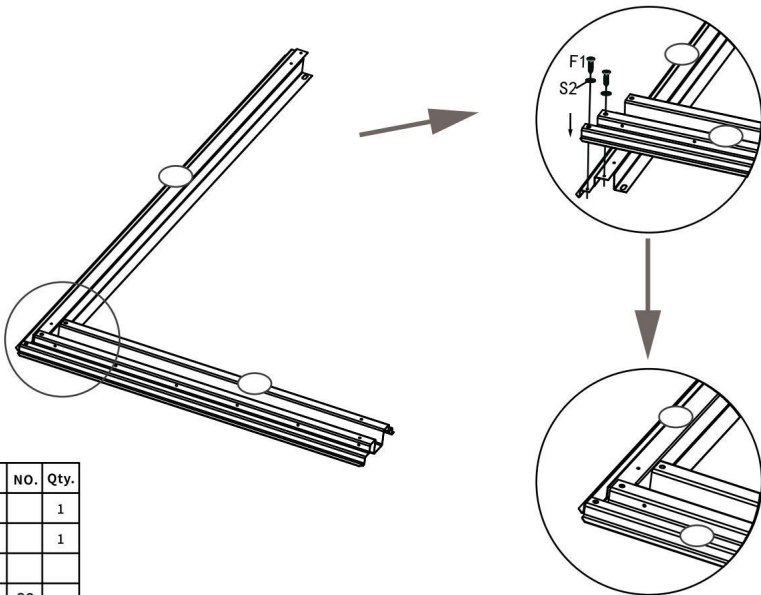

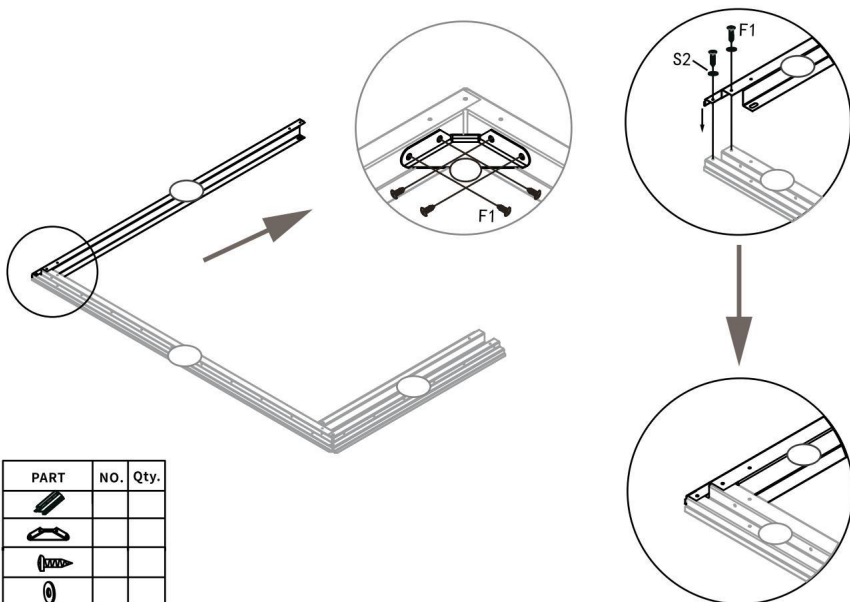

PART	NO.	Qty.
		1
		1
	S2	



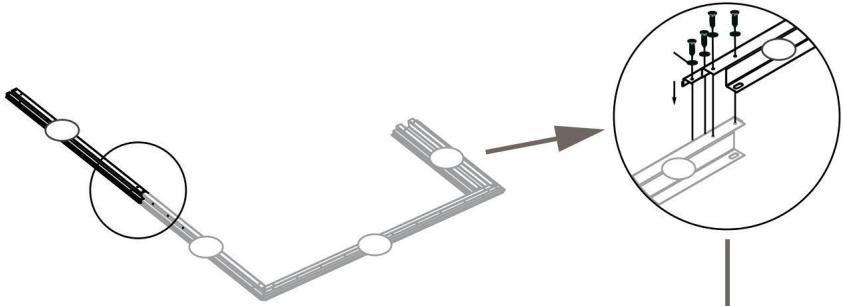



PART	NO.	Qty.

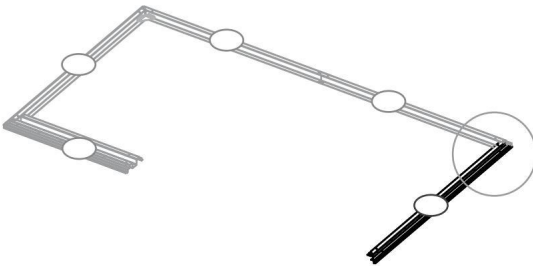
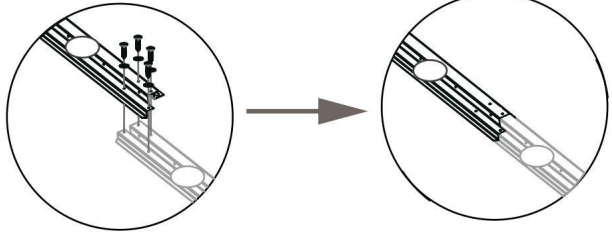

PART	NO.	Qty.
		1
		
		



PART	NO.	Qty.
		
		
		
		

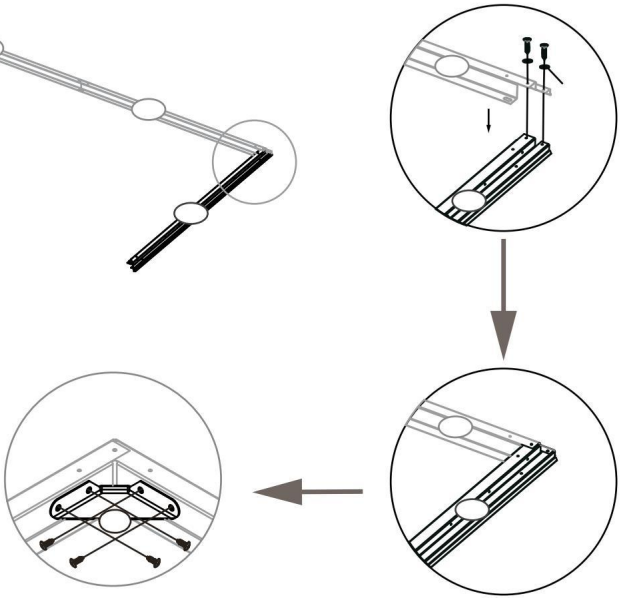

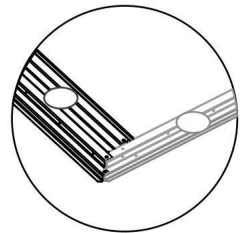
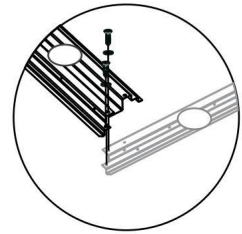
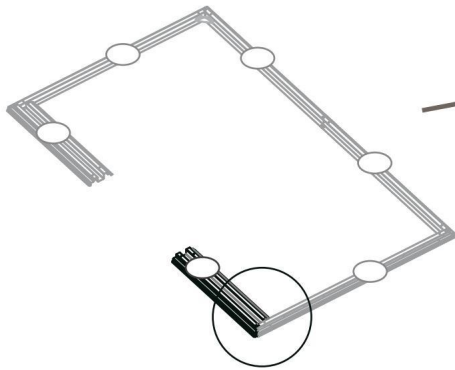



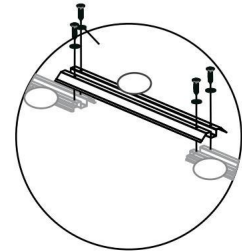
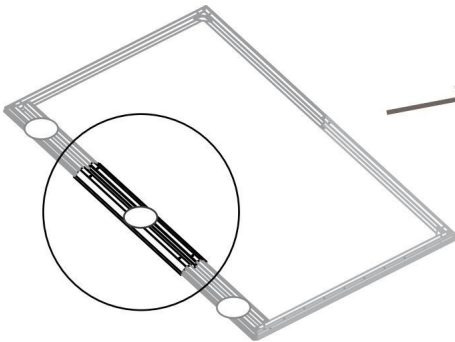

PART	NO.	Qty.
		1





PART	NO.	Qty.
		1

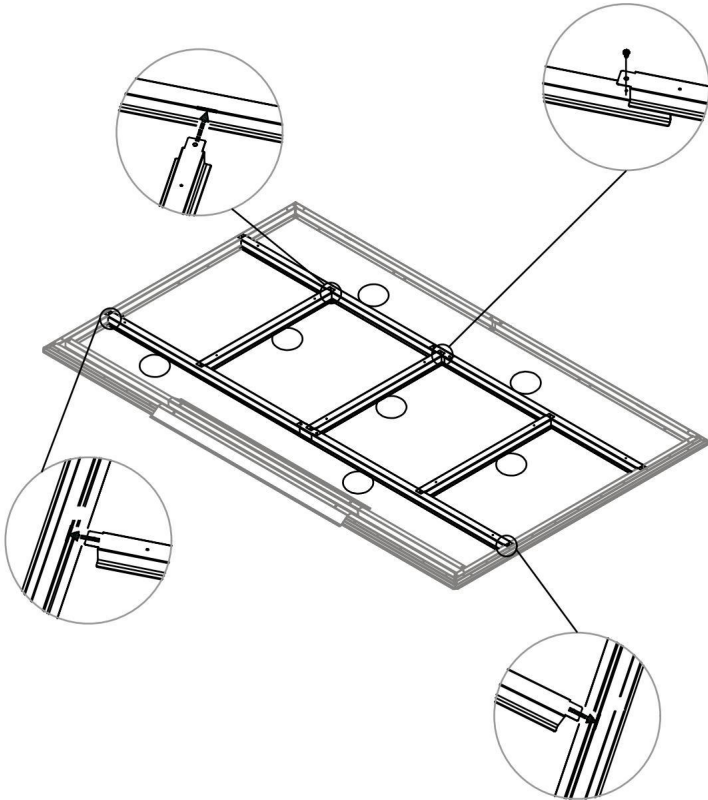

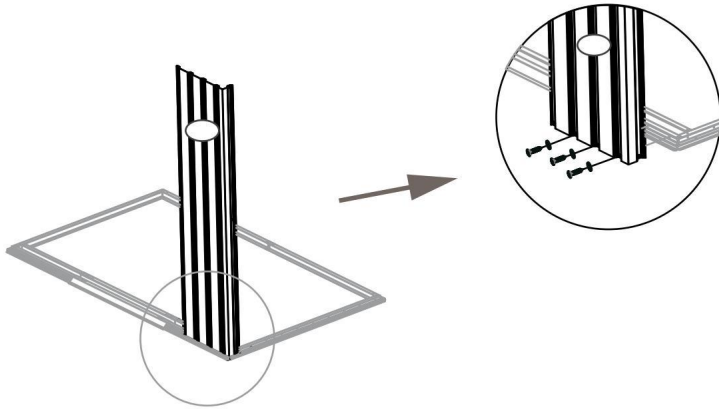





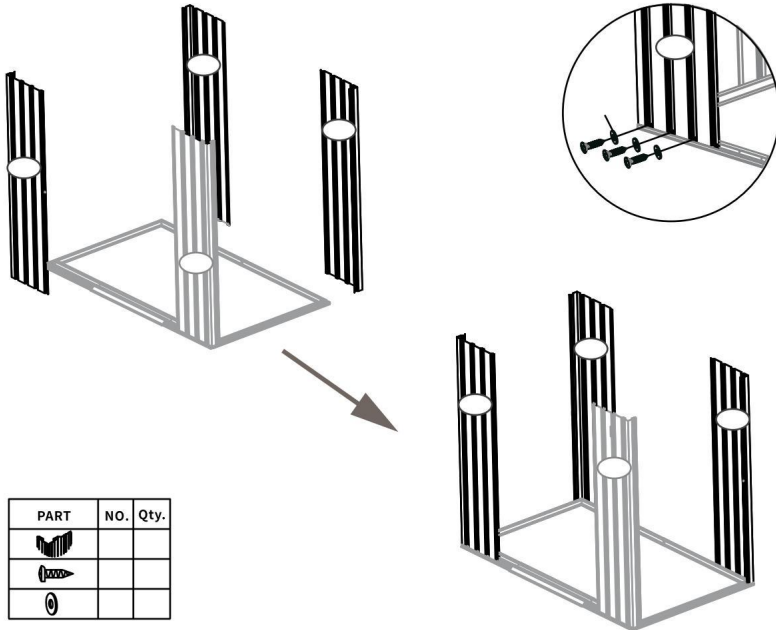



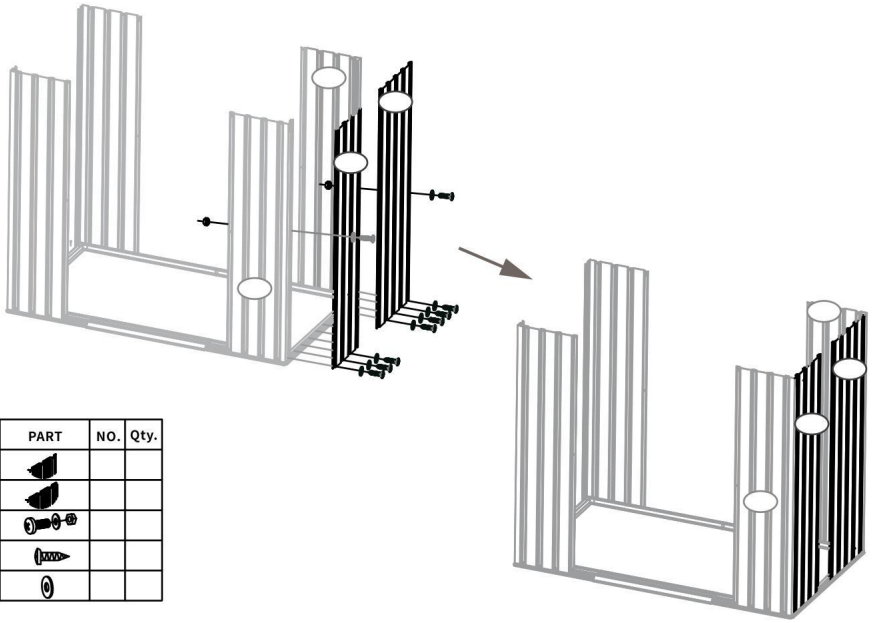

PART	NO.	Qty.
		
		
		









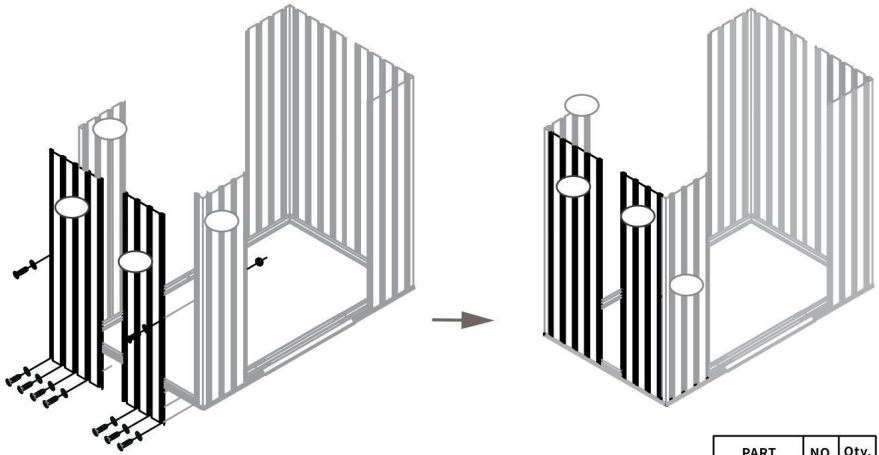

PART	NO.	Qty.
		
		
		







PART	NO.	Qty.
		
		
		
		
		



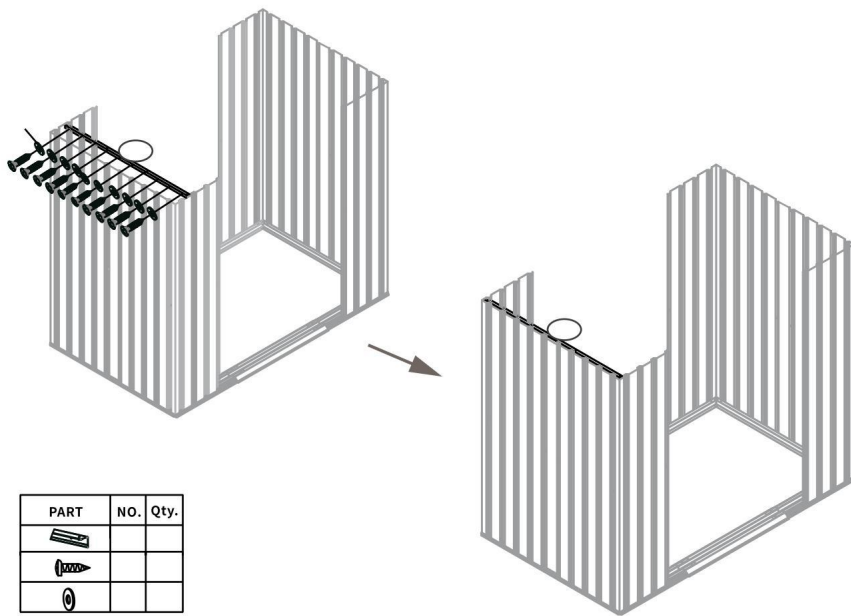
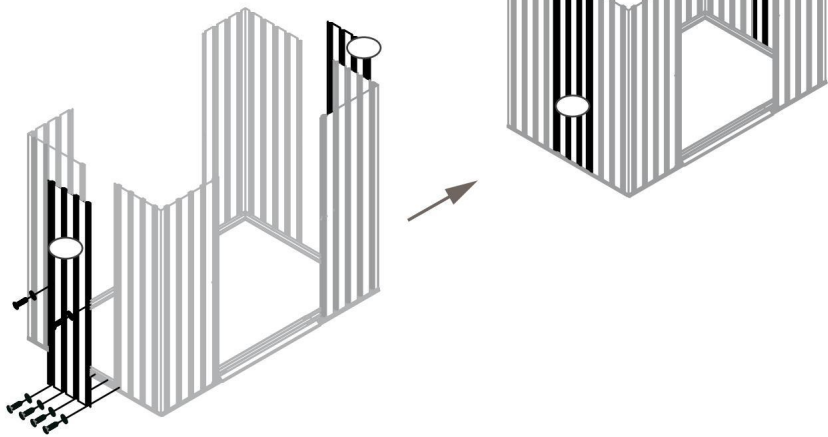



PART	NO.	Qty.
		
		
		
		
		

PART	NO.	Qty.
		
		
		
		

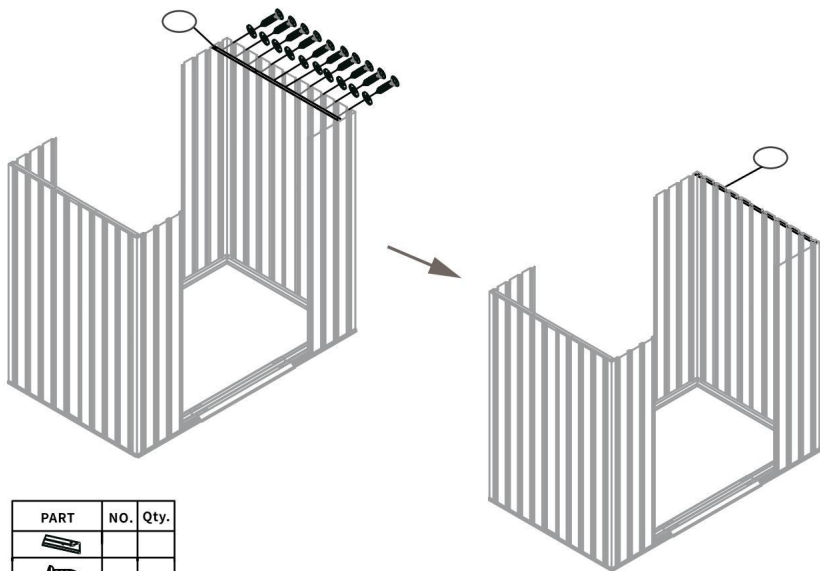





PART	NO.	Qty.
		
		
		

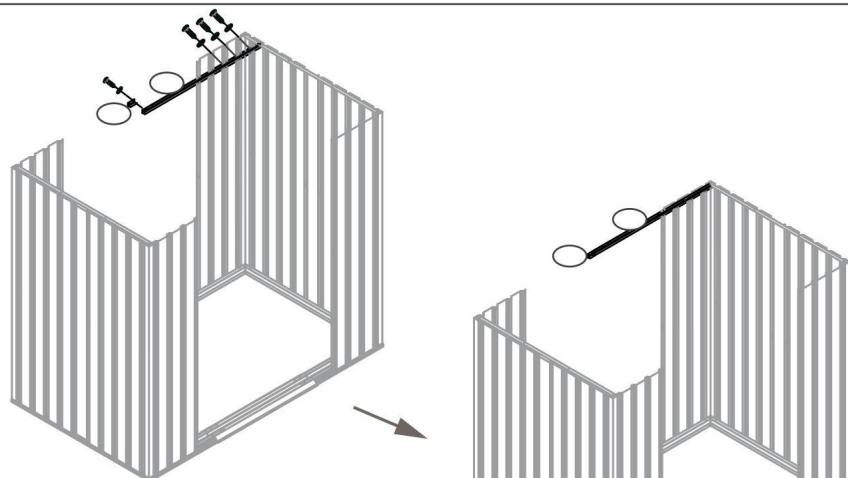



PART	NO.	Qty.
		
		
		



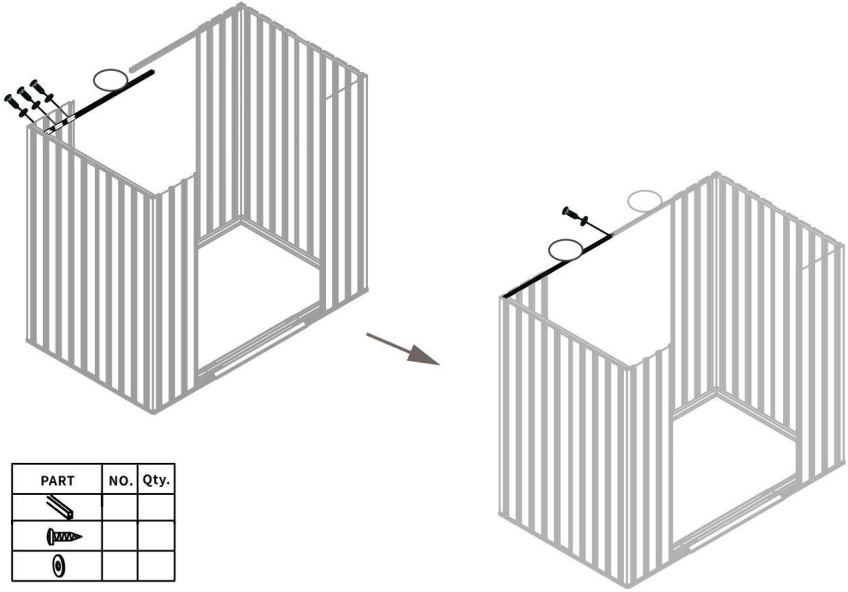



PART	NO.	Qty.
		
		
		
		

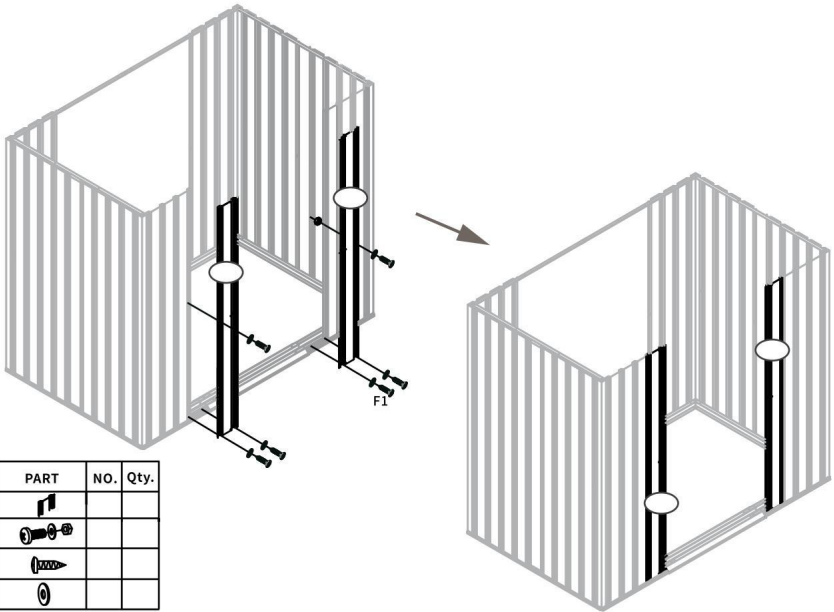

PART	NO.	Qty.
		
		
		



PART	NO.	Qty.
		
		
		
		

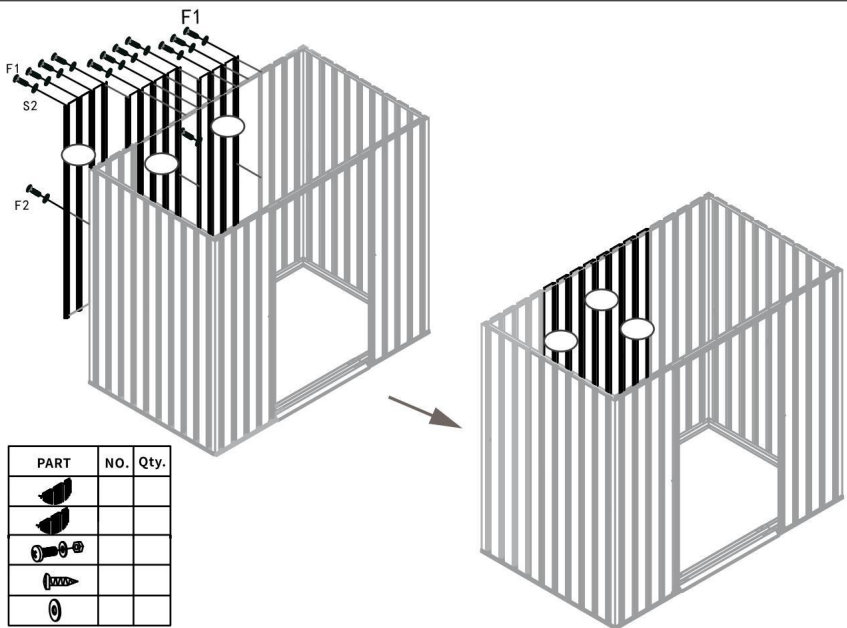
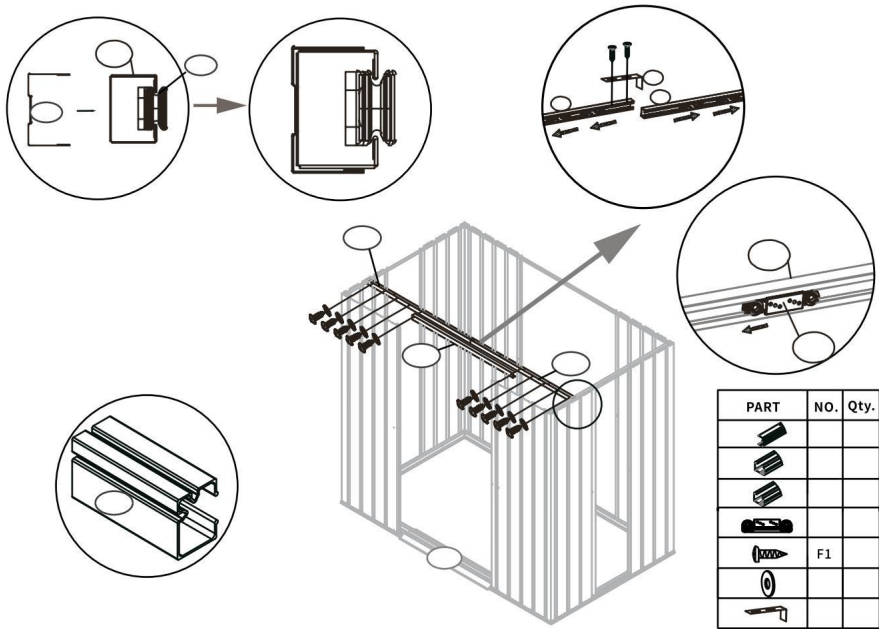

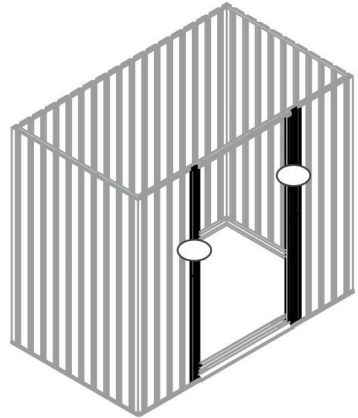
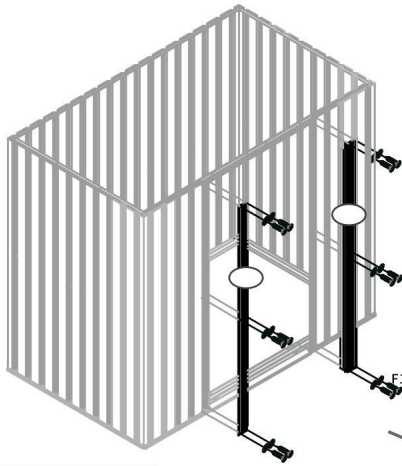



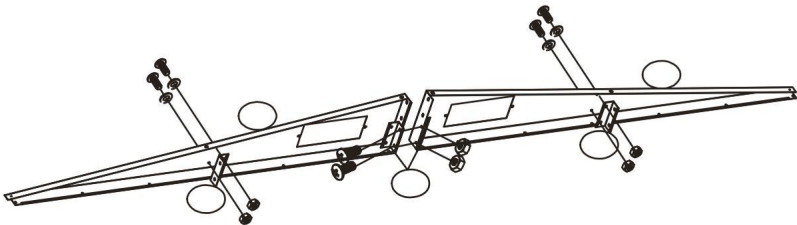

PART	NO.	Qty.



PART	NO.	Qty.

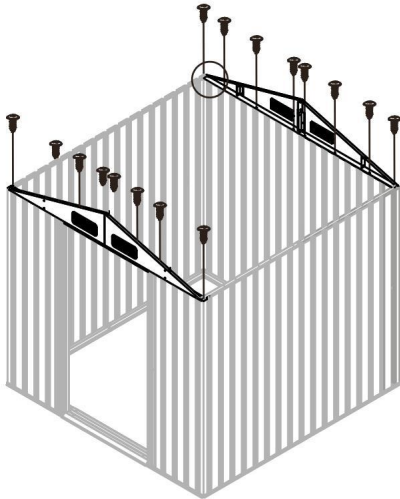
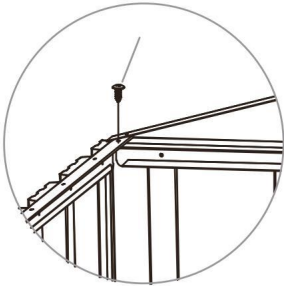
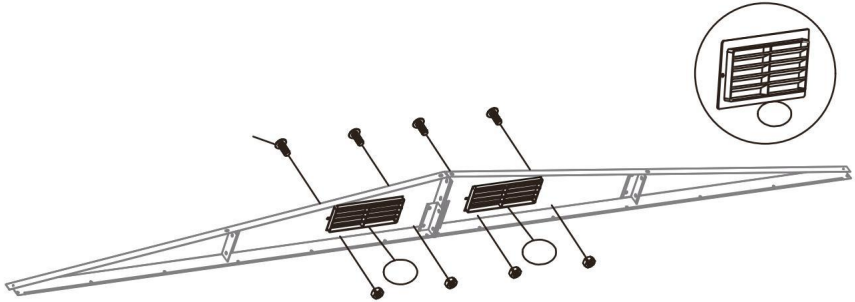



PART	NO.	Qty.
		
		



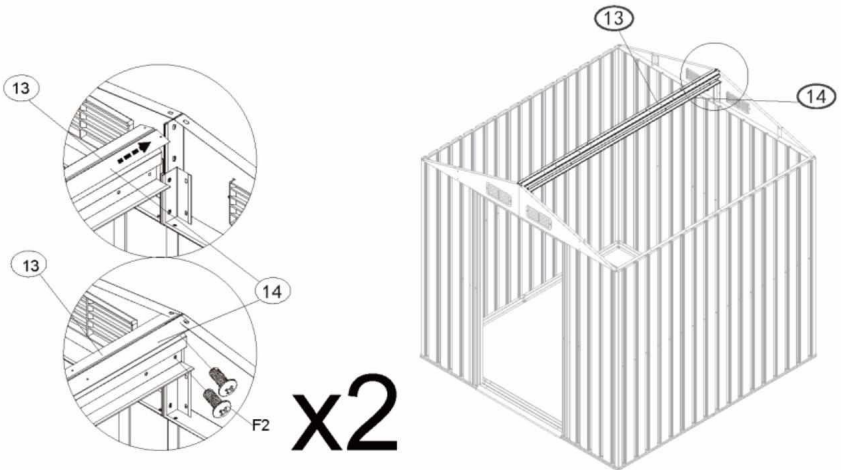
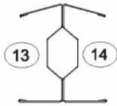
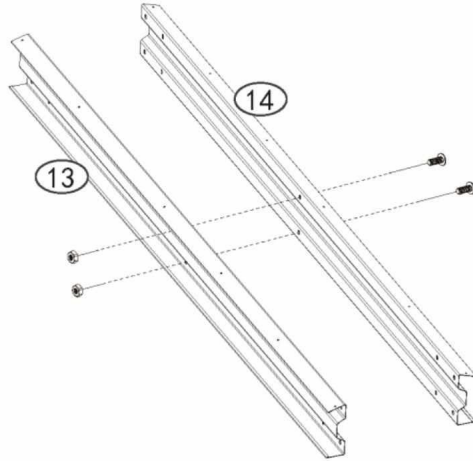

PART	NO.	Qty.
		



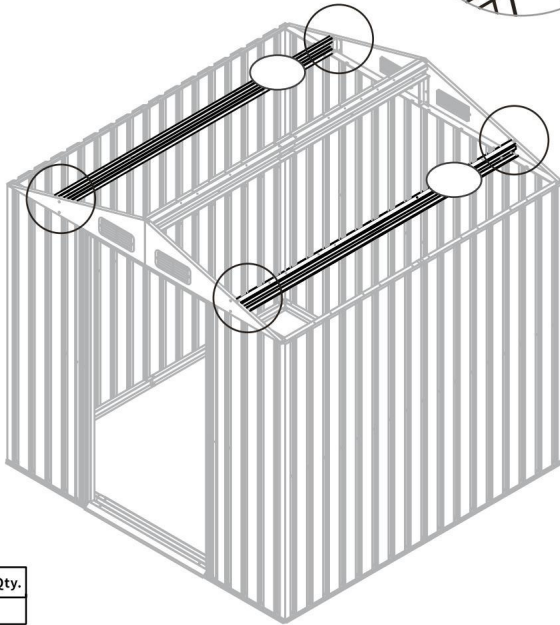
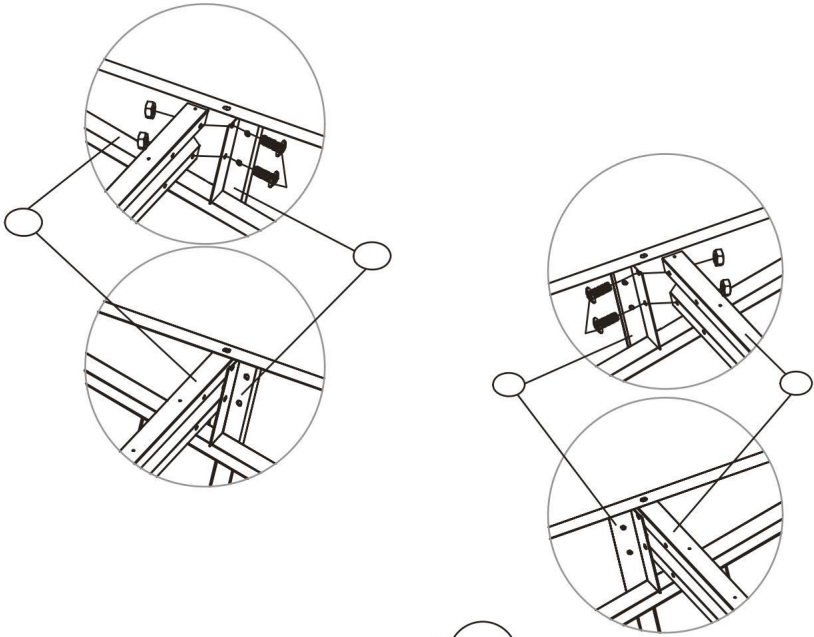

PART	NO.	Qty.
	13	1
	14	1
	F2	2









PART	NO.	Qty.
	F2	4

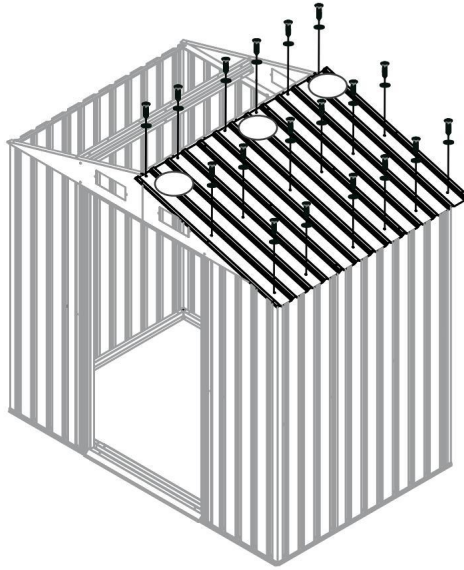





PART	NO.	Qty.
		

PART	NO.	Qty.
		
		
		
		
		

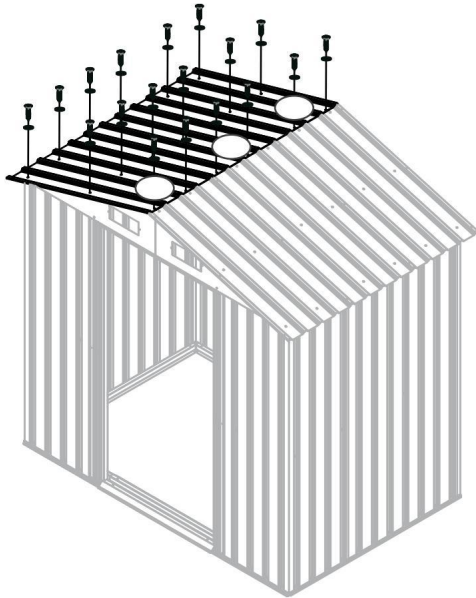





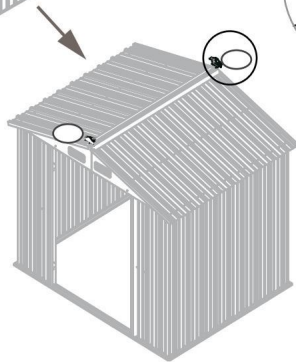
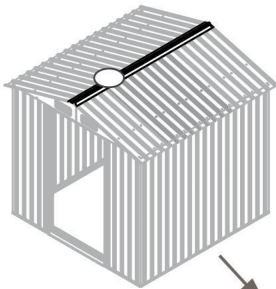
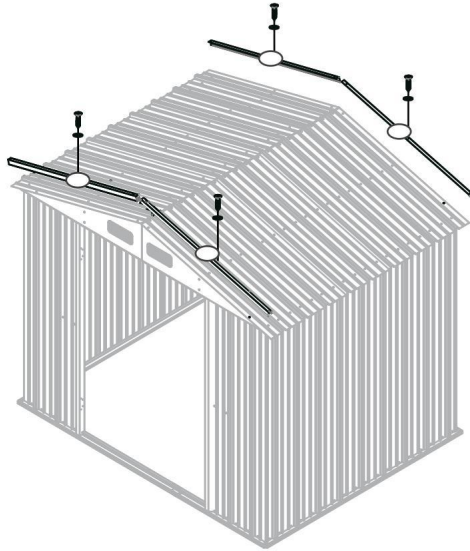

PART	NO.	Qty.
		
		
		
		
		



PART	NO.	Qty.
		
		
		
		



PART	NO.	Qty.
		
		
		

PART	NO.	Qty.
		
		
		
		

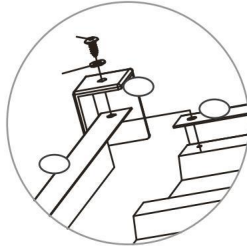
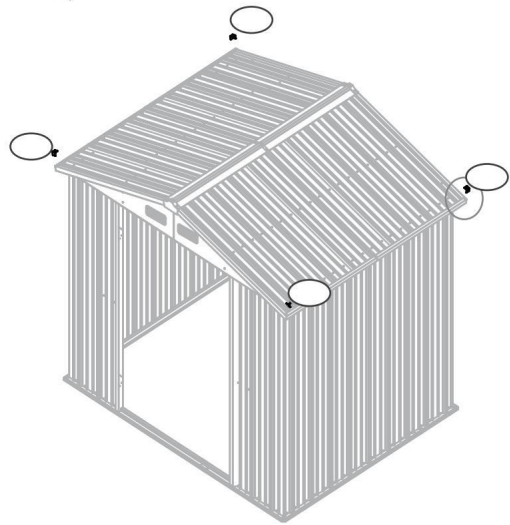
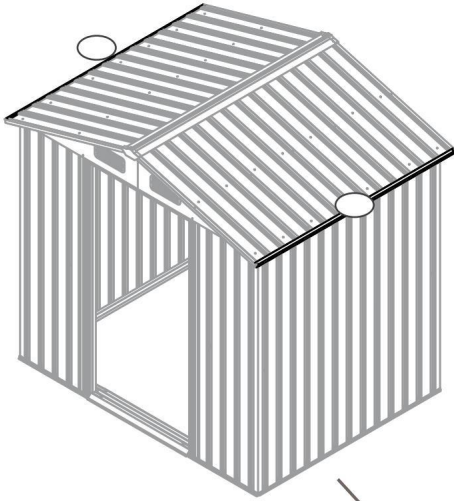

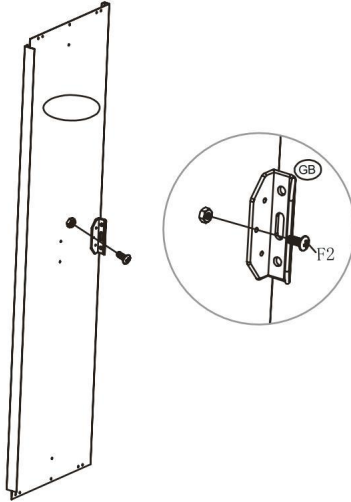



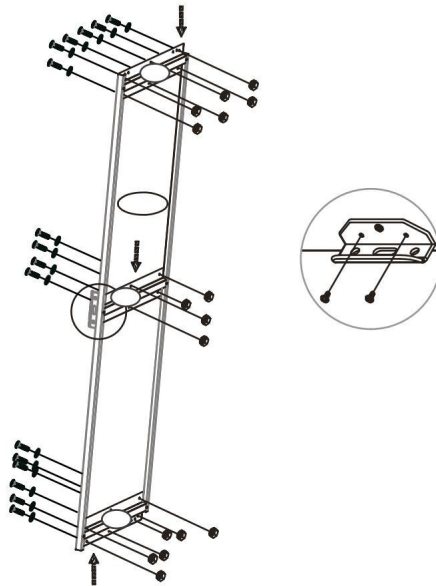

PART	NO.	Qty.

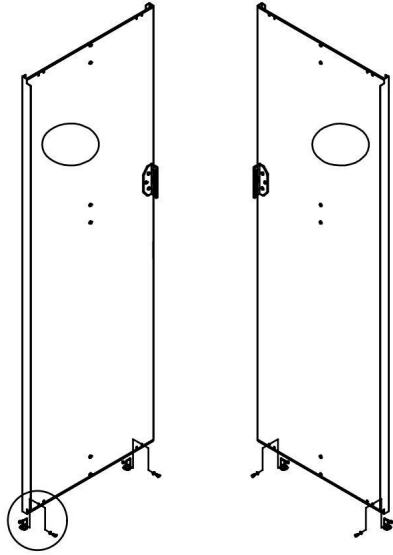
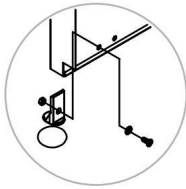

PART	NO.	Qty.



PART	NO.	Qty.
		
		
		

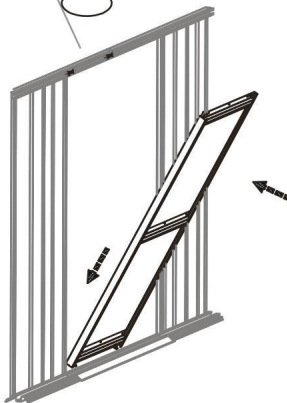
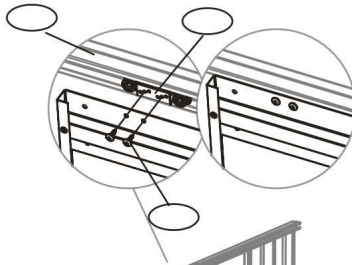

PART	NO.	Qty.
		

PART	NO.	Qty.
Ⓞ		

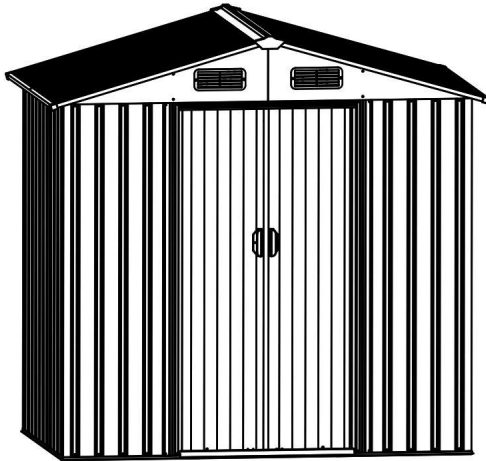
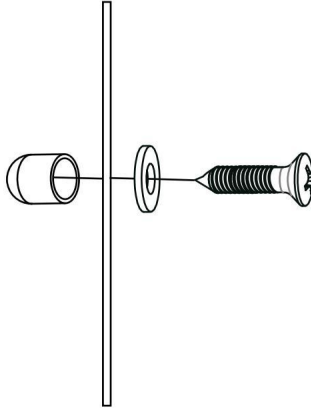



[www.deubaservice.de](http://www.deubaservice.de)

## SERVISNÝ PORTÁL

V prípade akéhokoľvek typu servisu, sťažností a technickej podpory sa môžete s dôverou obrátiť na náš vyškolený personál.

Vyrobené pre:

Deuba GmbH & Co. KG  
Zum Wiesenhof 84

66663 Merzig, Nemecko  
[kontakt@deuba.info](mailto:kontakt@deuba.info)

Vyrobené pre:

Deuba LTD  
Wyatt Way, Thetford  
Norfolk, IP24 1HB

Autorské práva



Verzia 2024/03 Rev6

Všetky práva vyhradené. Bez písomného súhlasu spoločnosti Deuba GmbH & Co. KG nesmie byť táto príručka reprodukována v akejkoľvek forme, či už ako celok alebo sčasti, ani duplikovaná či spracovávaná elektronickými, mechanickými alebo chemickými metódami. Zmeny môžu byť vykonané kedykoľvek bez predchádzajúceho upozornenia v záujme technického pokroku. Príručka je pravidelne aktualizovaná.

Nenesieme žiadnu zodpovednosť za technické a tlačové chyby a ich následky.