

| A | B        | C (mm) |     | D   |
|---|----------|--------|-----|-----|
| 1 | M130-403 | 920    | 535 | 1/1 |
| 2 | M130-585 | 922    | 60  | 1/1 |

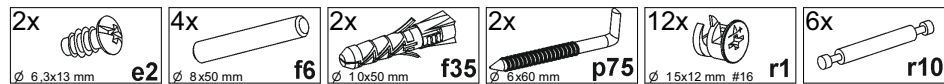

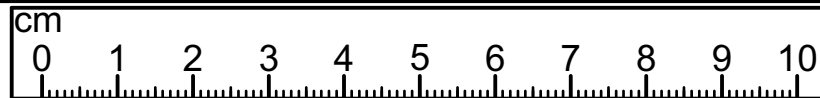

4

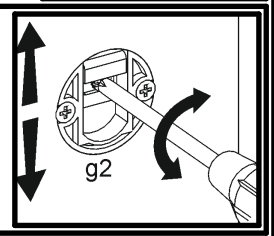
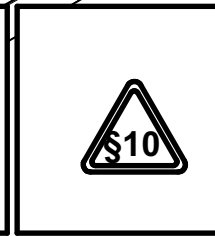
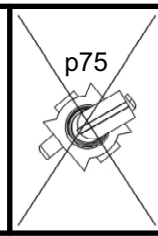
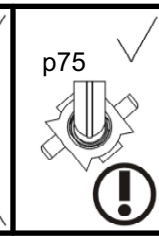
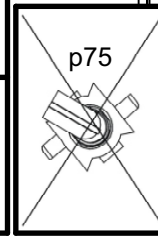
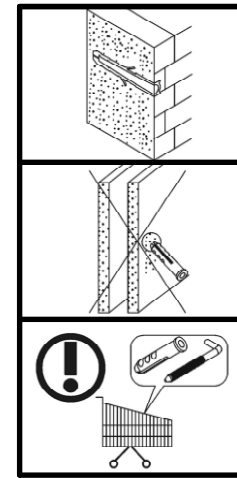
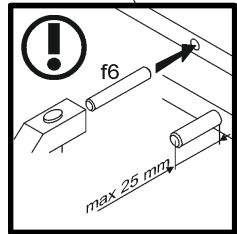
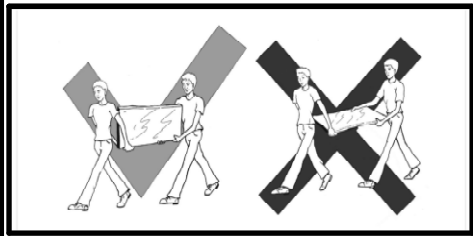
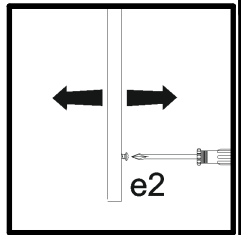
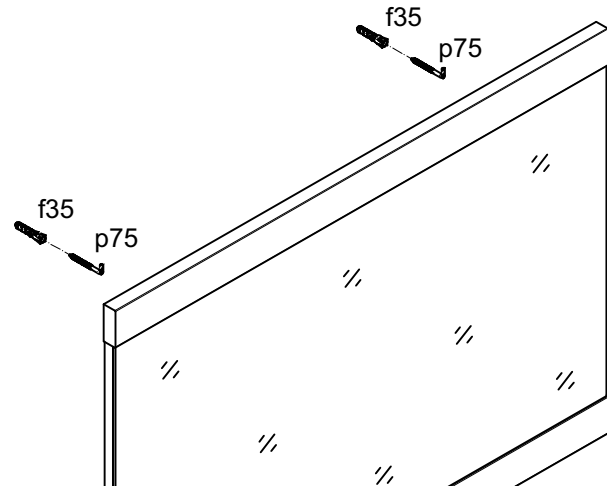
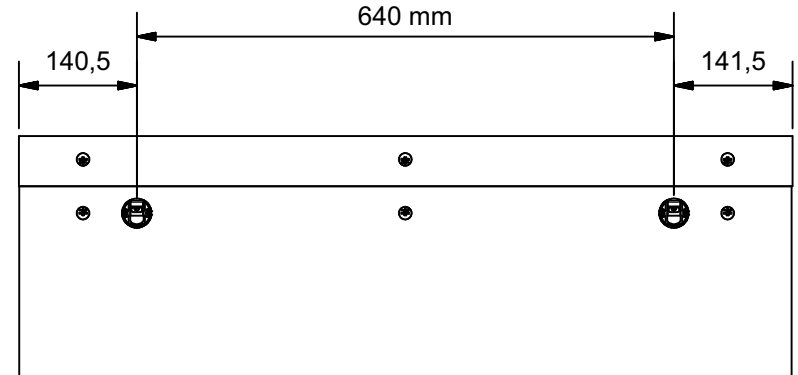
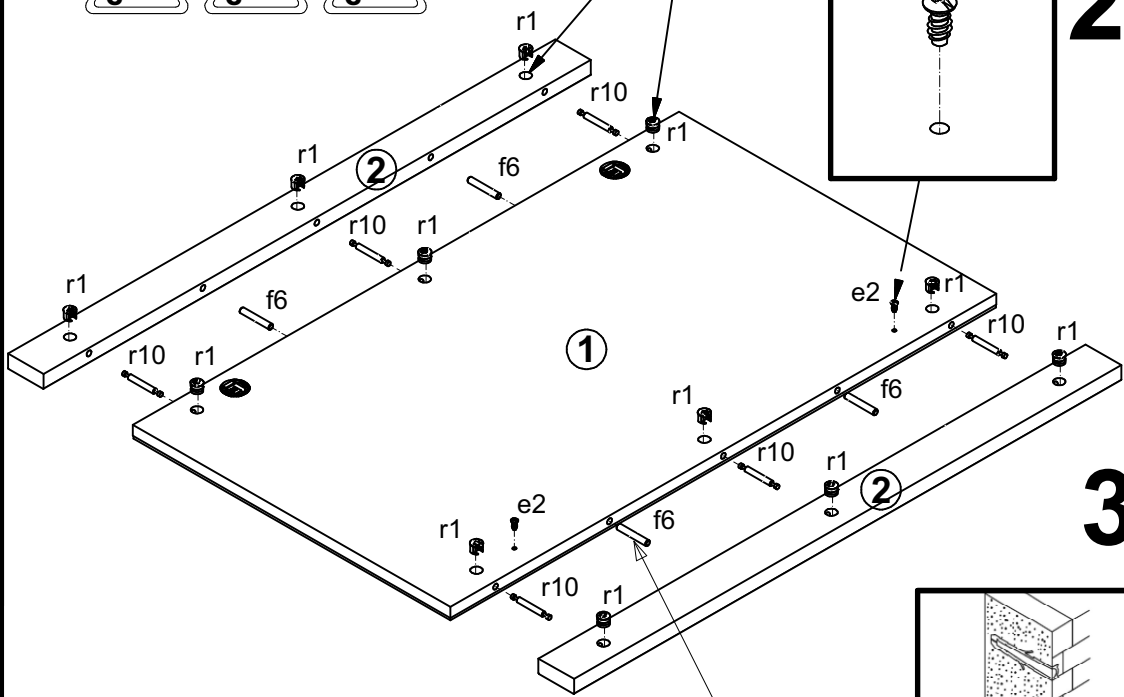
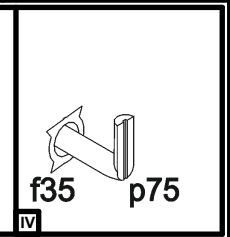
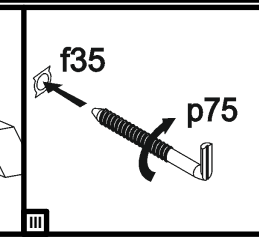
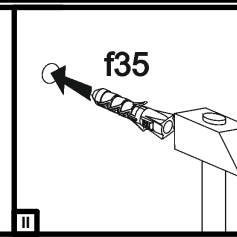
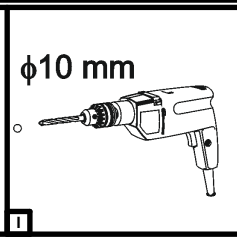
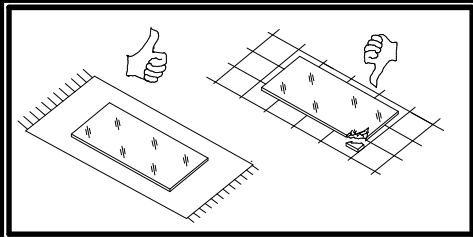